



Interpersonal Communication

A Mindful Approach to Relationships

Jason S. Wrench, Narissra M. Punyanunt-Carter, & Katherine S. Thweatt

Interpersonal Communication: A Mindful Approach to Relationships

Jason S. Wrench
Narissra M. Punyanunt-Carter
Katherine S. Thweatt

Copyright © 2020 by Jason S. Wrench, Narsissra M. Punyanunt-Carter, & Katherine S. Thweatt

Original cover art created for this book by Malinda Ashan.

ISBN: 978-1-942341-77-2

This work is licensed under the Creative Commons Attribution-NonCommercial-ShareAlike 4.0 International (CC BY-NC-SA 4.0) United States License.

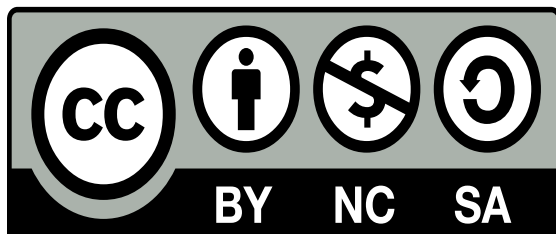

To view a copy of this license, visit <http://creativecommons.org/licenses/by-nc-nd/3.0/us/> or send a letter to Creative Commons, 171 Second Street, Suite 300, San Francisco, California, 94105, USA.

All images within this book have a Creative Commons License or are freely available under a different license type.

To get the full-size versions of these images go to:

<https://flic.kr/s/aHsmLojt6M>

Unless otherwise noted, all images within this book are attributed to Jason S. Wrench.

This book is published in conjunction with the Open SUNY Textbooks.

Table of Contents

Contents

Preface	xviii
A Note for Students.....	xix
Relationships	xix
Positive	xx
Negative	xx
No Relationship	xx
Note of Caution.....	xx
Differences	xxi
Differences of Kind.....	xxi
Differences of Degree	xxi
A Note for Professors.....	xxi
About the Authors.....	xxii
Jason S. Wrench.....	xxii
Narissra M. Punyanunt-Carter	xxiii
Katherine S. Thweatt.....	xxiii
Chapter 1: Introduction to Human Communication.....	1
Number of Communicators Involved.....	1
Physical Proximity of the Communicators.....	2
Nature of the Interaction Units	2
Degree of Formality and Structure.....	3
1.1 Why Study Communication?.....	3
Reasons to Study Communication	3
Communication Needs	4
Physical.....	4
Identity.....	5
Social	5
Practical	5
1.2 Basic Principles of Human Communication	6
Communication Is Symbolic.....	7
The Symbol is Not the Thing	8
Arbitrariness of Symbols	8
Communication Is Shared Meaning	9
Communication Involves Intentionality.....	11
Dimensions of Communication.....	11
Relational Dimension.....	11
Content Dimension.....	11
Communication Is a Process.....	12
Communication Is Culturally Determined	12
Communication Occurs in a Context	13
Communication Is Purposeful	13
1.3 Communication Competence	14

Defining Competence	14
Understanding Competence.....	15
Characteristics of Competence.....	15
Skillful.....	15
Adaptable	16
Involved.....	16
Understands Their Audience.....	16
Cognitive Complexity	16
Self-Monitoring.....	17
1.4 Types of Human Communication	18
Intrapersonal Communication	18
Interpersonal Communication	19
Small Group Communication.....	19
Public Communication.....	20
Mediated Communication	20
1.5 Understanding Mindful Communication.....	21
Defining Mindfulness	22
Towards a Mindfulness Model	23
Mindful Awareness.....	23
Mindful Practice	23
Attention.....	24
Intention	24
Attitude	24
Five Facets of Mindfulness	25
Observing	25
Describing.....	25
Acting with Awareness.....	26
Nonjudging of Inner Experience	26
Nonreactivity to Inner Experience	26
Interpersonal Communication and Mindfulness.....	28
Chapter Wrap-Up	30
Chapter 2: Overview of Interpersonal Communication	37
2.1 Purposes of Interpersonal Communication.....	38
Meeting Personal Needs.....	38
Communicating and Meeting Personal Needs	39
Learning About Self and Others	40
Building and Maintaining Relationships	41
Uncertainty Reduction Theory	42
2.2 Elements of Interpersonal Communication.....	43
Sender.....	44
Receiver	44
Message.....	44
Channel.....	45
Feedback.....	45
Environment.....	45
Noise.....	46
2.3 Perception Process	48
Perception.....	48
Attending	50

Organizing	51
Interpreting.....	51
Personal Experience.....	51
Involvement.....	52
Expectations	52
Assumptions	52
Relational Satisfaction.....	52
Conclusion.....	52
2.4 Models of Interpersonal Communication.....	53
Action Models	54
Shannon-Weaver Model.....	54
Early Schramm Model	54
Berlo's SMCR Model.....	55
Interaction Models	56
Osgood and Schramm Model.....	56
Watzlawick, Beavin, and Jackson Model.....	57
Transaction Models.....	58
Barnlund's Transactional Model	59
The Importance of Cues.....	59
The Importance of Context.....	59
The Importance of Noise	59
Transaction Principles.....	60
Communication is Complex.....	60
Communication is Continuous.....	60
Communication is Dynamic	61
Final Note.....	61
Towards a Model of Mindful Communication.....	61
2.5 Interpersonal Communication Skills.....	63
Listening Skills.....	63
People Skills	64
Emotional Intelligence.....	64
Appropriate Skill Selection	64
Communicating Ethically	64
We advocate truthfulness, accuracy, honesty, and reason as essential to the integrity of communication.	64
We endorse freedom of expression, diversity of perspective, and tolerance of dissent to achieve the informed and responsible decision making fundamental to a civil society.....	65
We strive to understand and respect other communicators before evaluating and responding to their messages.	65
We promote access to communication resources and opportunities as necessary to fulfill human potential and contribute to the well-being of individuals, families, communities, and society.....	65
We promote communication climates of caring and mutual understanding that respect the unique needs and characteristics of individual communicators.....	66
We condemn communication that degrades individuals and humanity through distortion, intimidation, coercion, and violence, and through the expression of intolerance and hatred.....	66
We are committed to the courageous expression of personal convictions in pursuit of fairness and justice.	66
We advocate sharing information, opinions, and feelings when facing significant choices while also respecting privacy and confidentiality.....	66

We accept responsibility for the short- and long-term consequences for our own communication and expect the same of others.....	67
Chapter Wrap-Up	68
Chapter 3: Intrapersonal Communication	73
3.1 Who Are You?.....	74
Self-Concept	74
The Three Selves	75
Self-Image.....	76
Self-Worth.....	76
Ideal-Self.....	76
Three Self's Working Together.....	77
Self-Esteem	78
Defining Self-Esteem.....	78
Subjective Evaluation	78
Abilities.....	79
Limitations.....	80
Self-Esteem and Communication	80
Self-Compassion	81
Self-Kindness.....	82
Common Humanity.....	82
Mindfulness	82
Don't Feed the Vulture	83
3.2 Personality and Perception in Intrapersonal Communication	86
Personality	86
Nature or Nurture	86
Minnesota Twins Raised Apart.....	87
Twin Research in Communication	88
Temperament Types.....	88
The Big Five	90
Openness.....	91
Conscientiousness	91
Extraversion.....	92
Agreeableness.....	92
Neuroticism.....	92
Cognitive Dispositions.....	93
Locus of Control	93
Cognitive Complexity	94
Authoritarianism/Dogmatism.....	94
Emotional Intelligence	95
Personal-Social Dispositions	97
Loneliness.....	97
Depression.....	97
Self-Esteem	97
Narcissism.....	98
Machiavellianism.....	98
Empathy	99
Self-Monitoring.....	99
3.3 Communication & Relational Dispositions.....	101
Communication Dispositions.....	101

Introversion/Extraversion.....	101
Approach and Avoidance Traits.....	102
Shyness.....	102
Communication Apprehension.....	102
Willingness to Communicate.....	103
Argumentativeness/Verbal Aggressiveness.....	104
Sociocommunicative Orientation.....	104
Responsiveness.....	105
Assertiveness.....	105
Versatility.....	105
Sociocommunicative Orientation and Interpersonal Communication.....	105
Relational Dispositions.....	106
Attachment.....	107
Rejection Sensitivity.....	108
Chapter Wrap-Up.....	110
Chapter 4: Verbal Elements of Communication.....	121
4.1 How Words Work.....	122
Words and Meaning.....	122
Semantic Rules.....	122
Syntactic Rules.....	122
Pragmatic Rules.....	123
Words Create Reality.....	123
Words Reflect Attitudes.....	124
Level of Abstraction.....	124
Metamessages.....	126
Words and Meanings.....	126
4.2 Functions of Language.....	128
Instrumental and Regulatory Functions.....	128
Interactional and Imaginative Functions.....	128
Personal Functions.....	128
Heuristic and Representational Functions.....	129
Cultural Functions.....	129
Naming and Identity.....	130
Affiliation.....	131
Sexism and Racism.....	132
Muted Group Theory.....	133
4.4 Types of Language.....	135
Formal vs. Informal Language.....	135
Formal Language.....	136
Informal Language.....	136
Jargon.....	136
Colloquialisms.....	137
Slang.....	137
Idioms.....	138
Clichés.....	142
Improper Language.....	142
Biased Language.....	143
Ambiguous Language.....	143
Euphemisms.....	144

Relative Language	144
Static Evaluation	144
4.5 Improving Verbal Communication	145
Improving Language Skills	145
Use Repetition.....	146
Group Similar Words Together	146
Build Your Vocabulary	146
Read.....	147
Increase Your Awareness and Adaptation of Language	147
Check for Understanding.....	147
Chapter Wrap-Up	148
Chapter 5: Nonverbal Communication.....	154
5.1 Importance of Nonverbal Communication in Interaction.....	155
The Role of Nonverbal in Everyday Life.....	155
Nonverbal has Communicative Value	155
Nonverbal Used for Relational Purposes	156
Nonverbal is Ambiguous.....	156
Nonverbal is Culturally Based.....	157
Attribution Error	157
Omnipresent	158
Can Form Universal Language.....	158
Can Lead to Misunderstandings	158
Usually Trusted	159
The Six Functions of Nonverbal Communication.....	160
Complementing.....	160
Contradicting.....	160
Accenting.....	161
Repeating.....	161
Regulating	161
Substituting	161
5.2 Categories of Nonverbal Communication.....	162
Haptics.....	162
Vocalics.....	164
Timbre.....	164
Tempo.....	164
Intensity	
164	
Other Vocal Features	164
Paralanguage.....	164
Pauses and Silences.....	166
Dysfluencies, Vocal Fillers, or Verbal Surrogates.....	167
Kinesics.....	167
Facial Expressions	167
Oculesics.....	167
Gestures.....	168
Emblems	168
Illustrators.....	168
Affect Displays.....	168
Regulators.....	168

Proxemics	168
Artifacts.....	169
Chronemics	170
Olfactics	170
Physical Appearance.....	171
Somatotypes	171
Physical Appearance and Society.....	174
Body Positivity.....	174
Reclaim Health.....	175
Practice Intuitive Self-Care.....	176
Cultivate Self-Love	176
Declare Your Own Authentic Beauty.....	177
Build Community.....	177
The Matching Hypothesis.....	178
5.3 Improving your Nonverbal Skills	180
The Nonverbal Mindset.....	180
Nonverbal Immediacy.....	181
Chapter Wrap-Up	182
Chapter 6: Cultural and Environmental Factors in Interpersonal Communication.....	190
6.1 What is Culture?	191
Co-cultures.....	193
Microcultures.....	193
6.2 The Function of Culture	195
Collective Self-Esteem	195
Stereotyping.....	196
Culture as Normative	197
6.3 Cultural Characteristics and Communication	199
Edward T. Hall.....	199
Geert Hofstede	201
Low vs. High Power Distance	201
Individualism vs. Collectivism.....	202
Masculinity vs. Femininity.....	202
Low vs. High Uncertainty Avoidance	203
Long-Term vs. Short-Term Orientation.....	203
Indulgence vs. Restraint	204
Stella Ting-Toomey.....	205
6.4 Improving Intercultural Communication Skills	207
Become Culturally Intelligent.....	207
Four Factors of Cultural Intelligence	207
Cognitive CQ.....	207
Motivational CQ.....	208
Metacognitive CQ	208
Behavioral CQ	208
Engaging Culturally Mindful Interactions	208
Chapter Wrap-Up	211
Chapter 7: Talking and Listening.....	218
7.1 The Importance of Everyday Conversations	218
Types of Conversations	219
Discourse.....	220

Dialogue	220
Debate	220
Diatribes	221
Communication Needs	221
7.2 Sharing Personal Information	222
Motives for Self-Disclosure	223
Social Integration.....	223
Impression Management.....	224
Self-Descriptions	224
Accounts.....	224
Apologies.....	224
Entitlements and Enhancements	225
Flattery.....	225
Favors	225
Social Penetration Theory.....	225
Johari Window	226
Open Self.....	227
Hidden Self	227
Blind Self.....	228
Unknown Self.....	228
7.3 Listening.....	229
Hearing Is Not Listening.....	229
Model of Listening	230
Hearing.....	230
Understanding.....	231
Remembering.....	231
Interpreting.....	231
Evaluating	231
Responding.....	232
Taxonomy of Listening	232
Discriminative.....	232
Comprehensive	232
Therapeutic	233
Critical	233
Appreciative.....	233
Listening Styles	233
The Four Listening Styles	234
People.....	234
Action	234
Content.....	234
Time	234
Thinking About the Four Listening Types	235
7.4 Listening Responses	240
Types of Listening Responses	240
Silent Listening	241
Questioning	242
Paraphrasing	242
Empathizing.....	243
Supporting.....	243

Analyzing	243
Evaluating	243
Advising	243
Perception Checking	243
Selection	244
Organization	244
Interpretation.....	245
Negotiation	245
Influences on Perception	245
Physiological Influences	246
Psychological Influences.....	246
Social Influences.....	246
Cultural Influences	247
Perception Checking	248
Chapter Wrap-Up	248
Chapter 8: Building and Maintaining Relationships	255
8.1 The Nature of Relationships	256
Relationship Characteristics	256
Significant Relationships.....	257
Purposes of Relationships	257
Elements of a Good Relationship	257
8.2 Relationship Formation	258
Understanding Attraction	258
Reasons for Attraction.....	259
Physical Proximity	259
Physical Attractiveness.....	259
Perceived Gain	259
Similarities and Differences	260
Disclosure	261
8.3 Stages of Relationships	261
Coming Together	262
Initiating.....	262
Experimenting	263
Intensifying	263
Integrating.....	263
Bonding	263
Coming Apart	263
Differentiating.....	263
Circumscribing	264
Stagnating.....	264
Avoiding	264
Terminating.....	264
Final Thoughts on Coming Together	264
Relationship Maintenance	265
8.4 Communication in Relationships	267
Relationship Dialectics	267
Separation-Integration	268
Predictability-Noveltly	268
Openness-Closedness.....	268

Similarity-Difference.....	268
Ideal-Real.....	269
Self-Disclosure.....	269
Alternatives to Self-Disclosure.....	270
8.5 Dating Relationships.....	271
Dating Scripts.....	272
Love Styles.....	276
Eros.....	276
Storge.....	276
Ludic.....	276
Agape.....	277
Pragma.....	277
Mania.....	277
8.6 How Gender Affects Relationships.....	279
Biological Sex vs. Gender.....	279
Gender Differences in Interpersonal Communication.....	279
Sex Differences in Interpersonal Communication	280
Improving Communication Skills	280
Chapter Wrap-Up	281
Chapter 9: Conflict in Relationships.....	289
9.1 Understanding Conflict	289
Two Perspectives on Conflict.....	290
Disruptions in Normal Workings of a System.....	290
Normal Part of Human Communication.....	291
Interpersonal Conflict.....	292
People are Interdependent	292
People Perceive Differing Goals/Outcomes of Means to the Same Ends	292
Conflict Can Negatively Affect the Relationship if Not Addressed.....	292
Some Sense of Urgency to Resolve Conflict.....	293
9.2 Emotions and Feelings	294
Emotional Awareness	296
The Problem of You Statements	298
Emotional Intelligence.....	300
Letting Go of Negative Thoughts.....	302
Positive Emotions During Conflict.....	302
9.3 Power and Influence.....	304
Levels of Influence	305
Compliance	305
Identification.....	305
Internalization.....	305
French & Raven's Five Bases of Power.....	305
Informational.....	306
Coercive and Reward	306
Legitimate	307
Expert	307
Referent.....	307
Influence and Power	308
9.4 Conflict Management Strategies	309
ABC's of Conflict	309

Avoiders.....	311
Battlers.....	312
Collaborators	313
STLC Conflict Model	314
Stop.....	315
Think.....	315
Listen	316
Communicate	316
Chapter Wrap-Up	318
Chapter 10: Friendship Relationships	326
10.1 Friendship Relationships	328
Friendship Characteristics	328
All Friendships are Essentially Voluntary	328
Friendships are Personal Relationships that are Negotiated Between Two Individuals	329
Friendships Have a Spirit of Equality	329
Friendships Have Mutual Involvement.....	329
Friendships Have Affective Aspects.....	330
Communication and Friendship Formation	330
Communication Competence	330
Communication Apprehension	331
Dialectical Approaches to Friendships.....	331
Contextual Dialectics.....	331
Private/Public	331
Ideal/Real	332
Interactional Dialectics	332
Independence/Dependence.....	332
Affection/Instrumentality	333
Judgment/Acceptance	333
Expressiveness/Protectiveness.....	334
10.2 Stages and Types of Friendships	336
Stages of Friendships	336
Role Delimited Interaction	336
Friendly Relations.....	337
Moves-Toward-Friendship	337
Nascent Friendship.....	338
Stabilized Friendship.....	338
Waning Friendship.....	339
Post-Friendship.....	339
Friendship Styles.....	340
Independent	340
Discerning.....	340
Acquisitive	341
Good and Bad Friendships	341
Ideal Friendship	342
Waning Friendship.....	342
Problematic Friendship.....	342
Deviant Friendship.....	342
10.3 Friendships in Different Contexts	344
Gender and Friendships.....	344

Same-Sex Friendships	345
Opposite Sex Friendships	346
Emotional Bond.....	346
Sexuality.....	347
Inequality and Power	347
Public Relationships	347
Opportunity Structure.....	348
Cross-Group Friendships	349
Mediated Friendships.....	350
What’s a Friend?.....	351
Technologies and Friendships	353
Chapter Wrap-Up	355
Chapter 11: Family & Marriage Relationships	361
11.1 Family Relationships.....	362
Defining Family	362
Marriage, Blood, Adoption, or Choice.....	365
Family Roles	366
Common Culture	366
Economic Cooperation.....	366
Children.....	367
Established Boundaries.....	367
Love and Trust.....	367
Family Communication Patterns.....	368
Socio-Orientation	368
Concept-Orientation	368
Four Combinations	368
Consensual	369
Protective.....	369
Pluralistic	369
Laissez-faire	370
Family Systems Theory	370
Characteristics of Family Systems	372
Interdependence	372
Wholeness.....	372
Patterns/Regularities.....	372
Interactive Complexity	373
Openness.....	373
Complex Relationships	374
Equifinality	374
Mapping Family Systems.....	375
11.2 Family Changes.....	381
Family Life Cycle.....	381
Young Singles	382
Young Couples (No Children).....	382
Full Nest One (Pre-School Children)	383
Full Nest Two (School-Aged Children)	383
Full Nest Three (Older Children).....	384
Empty Nest One (Still Working, Launched Children)	384
Empty Nest Two (Retired)	384

Solitary Survivor (Retired)	385
Problems with Life Cycle Research.....	385
11.3 Sibling Types	386
Sibling Relationship Types	387
Harmonious	387
Hostile	387
Affect-Intense	388
Uninvolved	388
Sibling Relationship Maintenance	388
Confirmation	388
Humor.....	388
Social Support	389
Family Events	389
Escape.....	389
Verbal Aggression.....	389
11.4 Marriage Relationships	391
Marital Types.....	391
Relational Dimensions	392
Conventional vs. Nonconventional Ideology.....	392
Ideology of Traditionalism.....	392
Ideology of Uncertainty and Change	392
Interdependence vs. Autonomy.....	392
Sharing.....	393
Autonomy	393
Undifferentiated Space	393
Temporal Regularity	393
Conflict Engagement vs. Avoidance.....	393
Conflict Avoidance.....	393
Assertiveness	394
The Relational Definitions	394
Traditionals	394
Independents.....	395
Separates.....	395
Same-Sex Marriages	395
Chapter Wrap-Up	397
Chapter 12: Interpersonal Communication in Mediated Contexts	406
12.1 Technology and Communication.....	407
From Math to Punch Cards	407
Getting Computers to Interact.....	408
Allowing People to Communicate	409
Asynchronous Communication	410
Synchronous Communication.....	410
The World Wide Web.....	411
12.2 The CMC Process	412
Synchronous and Asynchronous Communication	413
Nonverbal Cues.....	413
CMC Rules and Norms.....	414
Netiquette	415
Contexts.....	415

Rules and Norms.....	416
Acceptable and Polite CMC Behavior.....	416
Online Interaction.....	417
Range of Mediating Technologies.....	417
Communication Factors	417
Communication Apprehension	418
Online Impression Formation	421
Co-Present Interactions and Mediated Communication	423
Enabling.....	424
Facilitating.....	424
Inviting.....	425
Encouraging.....	425
12.3 Taking the Self Online	426
Erik Erikson	426
Your Online Identity.....	428
Erving Goffman and Identity	428
Types of Online Identities	429
Anonymous Identity.....	429
Pseudonymous Identity.....	430
Real Life Identity.....	431
12.4 Theories of Computer-Mediated Communication.....	432
Uses and Gratifications Theory.....	432
Social Presence Theory	433
Media Richness Theory	434
Social Information Processing Theory.....	434
Chapter Wrap-Up	436
Chapter 13: Interpersonal Relationships at Work.....	444
13.1 The Requirements of Professionalism.....	445
The Requirements of Professionalism.....	446
Ethics	446
Respect for Others	448
Personal Responsibility	451
Language Use	452
Formal Language.....	452
Use of Jargon and Specialized Language	453
13.2 Leader-Follower Relationships.....	455
Perspectives on Leadership.....	455
Hersey and Blanchard’s Situational-Leadership Theory.....	455
Directing.....	455
Coaching.....	456
Supporting.....	456
Delegating.....	456
Leader-Member Exchange Relationships	457
Stages of LMX Relationships.....	457
Stranger Stage	457
Acquaintance Stage	458
Partner Stage	458
Outcomes of High LMX Relationships.....	458
Followership	460

Resource	460
Individualist	460
Implementer.....	460
Partner	461
13.3 Coworker (Peer Relationships)	462
Characteristics of Coworker Relationships	462
Sias's Reasons for Workplace Relationships	462
Mentoring.....	462
Sources of Information	463
Issues of Power.....	463
Social Support	463
Other Characteristics.....	463
Trust	463
Relational Maintenance.....	464
Ability to Focus	465
Types of Coworker Relationships.....	465
Information Peers.....	465
Information Sharing	465
Workplace Socialization and Onboarding	466
Networking	466
Knowledge Management/Maintenance	466
Collegial Peers	466
Career Strategizing.....	466
Job-Related Feedback	467
Recognizing Competence and Performance.....	467
Friendship	467
Special Peers.....	467
Confirmation	467
Emotional Support.....	468
Personal Feedback	468
Friendship	468
A Further Look at Workplace Friendships	468
Friendship Development in the Workplace	469
Relationship Disengagement.....	470
State-of-the-Relationship Talk.....	470
Cost Escalation	470
Depersonalization	470
13.4 Romantic Relationships at Work	472
Understanding Romantic Workplace Relationships	472
A Model of Romantic Workplace Relationships	472
Personal Outcomes	473
Professional Outcomes	474
Organizational Outcomes	474
Ease of Opportunity	475
Similarity.....	475
Time	475
The Hook Up	475
How Coworkers View Romantic Workplace Relationships.....	481
13.5 Problematic Workplace Relationships.....	482

Problem Bosses	483
The Different Boss.....	484
The Good Old Boy or Good Old Girl Boss.....	484
The Okay Boss.....	484
The Toxic Boss.....	484
The Self-Centered Taskmaster	484
The Intrusive Harasser Boss.....	484
Problem Coworkers	485
The Adolescent.....	485
The Bully.....	485
The Mild Annoyance	485
The Independent Self-Promoter	486
The Pushy Playboy or Playgirl	486
The Independent Other	486
The Soap Opera Star	486
The Abrasive, Incompetent Harasser.....	486
Problem Subordinates.....	488
The Okay Subordinate	488
The Abrasive Harasser.....	488
The Bully.....	488
The Different Other.....	489
The Incompetent Renegade	489
Chapter Wrap-Up	490
Chapter 14: The Dark Side of Interpersonal Communication	499
14.1 Destructive Relationship Behaviors	500
Secret Testing	500
Directness Test.....	500
Endurance Test.....	501
Indirect Suggestions Test	501
Presenting the Relationship to Outsiders Test.....	501
Separation Test.....	501
Third-Party Test	501
Triangle Test	502
Empty Apologies	502
Internet Infidelity.....	502
Internet Characteristics Fostering Online Infidelity.....	503
Emotional vs. Sexual Infidelity.....	504
Hurtful Messages	504
Types of Hurtful Messages.....	505
Evaluations	505
Accusation	505
Directives.....	505
Informative Statements	505
Statement of Desire.....	505
Advising Statement.....	506
Question	506
Threats	506
Jokes	506
Lies	506

Reactions to Hurtful Messages.....	507
14.2 The Dark Side of Relationships: Aggression	508
Relational Aggression	508
Relationally Aggressive Categories	508
Relational Aggression in College: Bad and Normal	508
Verbal Aggression.....	509
Defining Verbal Aggression	509
Perceptions of Verbal Aggression	510
Bullying.....	510
Physical Bullying.....	511
Relational Bullying	511
Verbal Bullying.....	511
Cyberbullying.....	512
Workplace Bullying Typology	513
Communicating Effectively.....	515
Communicating Anger	515
Affirming Communicator Style	515
Deception	516
Types of Deception.....	516
Lies in Romantic Relationships.....	517
Domestic Violence or Intimate Partner Violence.....	518
Being Mindful.....	519
Chapter Wrap-Up	520



Image by [Engin Akyurt](#) from [Pixabay](#)

Preface

The term “interpersonal communication” refers to messages sent and received between two people. Most of our daily lives involve interpersonal communication on some level. When many people hear the word “interpersonal,” they immediately think of intimate relationships, but this is only one small fraction of the types of interpersonal interactions we have daily. Whether we are communicating with our spouse or dating partner, communicating with a coworker, communicating with a physician or therapist, or communicating with a random stranger, you are engaging in interpersonal communication. Interpersonal communication is the way people connect with other people.

William Schutz proposed three main reasons for why interpersonal communication is important to human beings in his Fundamental Interpersonal Relations Orientations Theory: control, inclusion, and affection.¹ The first need met through interpersonal relationships is our need to influence other people. People have an inherent need to control situations and the people within those situations. Whether we are talking about using persuasion attempts to get someone to go out with us on a date or using leadership skills to control what happens in the boardroom, control is a fundamental need for our interpersonal relationships. Most people don’t like thinking about interpersonal relationships as an issue of “control” because that doesn’t necessarily sound nice. It’s essential that we clearly distinguish control from manipulation. Control refers to an individual’s ability to influence another person’s behavior or ideas. When we talk about control, we are talking about influencing another person’s behavior or ideas because it is perceived as the right thing to do. Manipulation, on the other hand, is influencing another person’s behavior or ideas to one’s own advantage, often using dishonest, unscrupulous, and insidious means.

Control, in, and of itself, is neither good nor bad.

The second need we fulfill through interpersonal relationships is inclusion. Everyone wants to belong. As humans, we have an innate desire to belong to groups and social communities. At the most basic level, we belong to our families when we are born. As we age, the desire to belong to other groups we deem as positive continues. In school, we may want to belong to sports teams or social groups like a fraternity or sorority. When we enter the workforce, we want to feel like we belong in the workplace or belong within our professions by being a member of professional associations. Our need to feel like we belong is a basic need, and we fulfill this need through our daily interpersonal encounters.

The final need we fulfill through our interpersonal relationships is affection. The word “affection” stems from the Latin term *affectio*, which refers to emotions or feelings. Kory Floyd and Mark T. Morman defined “affection” as having an emotional state of fondness and positive regard toward a specific target.² As you can see, our understanding of affection is still rooted in the notions of emotion and feeling today. We all want to feel someone else’s positive affection towards us, whether it’s from our parents, coworkers, friends, siblings, children, etc. We also have an innate need to feel affection towards others.

Hopefully, you can see that these three basic human needs—control, inclusion, and affection—are essential constructs to everyone’s daily life and interactions. Furthermore, these are central tenets to who we are as human beings. Much of our success in life is built upon these three needs, so exploring these needs and how people accomplish them effectively is very important. The interpersonal communication strategies we discuss in this book are tools. As with many tools, they can either be used to enhance people’s lives or destruct them. A kind word and smile may make someone’s day, but an evil glare and a cutting remark can just as quickly destroy someone’s day. For this reason, we want you to consider what it means to be an ethical communicator just as much as we want you to consider how you communicate and react to others’ communication with you. Realize that the way you communicate and interact with others will impact their lives as much as it affects yours.

A Note for Students

Welcome to the world of interpersonal communication. We’re happy that you’re going to be joining us for this journey through the fascinating world of relationships in today’s modern world. In addition to this textbook, there’s also a student workbook that we’d encourage you to download and print. You can find the workbook on the [Open SUNY Textbook website](#). The workbook has a complete outline of the entire book, a wide range of activities, 20 unique adult color pages, a 16-week course planner, and so many other features. This workbook is a companion to this textbook. And it’s also available for you 100% free.

A number of the chapters in this text will contain information about research results, so we wanted to explain a couple of basic social scientific concepts before we jumped right into the text itself. A lot of the research in the world of interpersonal communication is based on statistics. Don’t worry; we’re not going to throw numbers at you within this textbook. However, it is crucial to understand a couple of basic concepts related to statistics: relationships and differences.

Relationships

The first major statistical concept that anyone studying the social sciences must understand is statistical relationships. We don’t want to get too technical in our discussion of relationships, but we do want to explain some of the basic ideas. When we examine relationships, we must have scores on two different

variables for a single person. Now the word “variable” simply refers to anything that can vary from person-to-person: for example, your height, weight, public speaking anxiety, best friend relationship satisfaction, etc. There are thousands of possible variables that social scientists studying interpersonal communication can examine. However, we generally don’t examine a single variable in isolation. We’re more likely to examine two or more variables.

To help us examine the idea of relationships, we’re going to use an article from Melissa Wanzer and Melanie Booth-Butterfield that examine someone’s “humor orientation.”³ The variable “humor orientation” is measured by a survey, which you can learn more about on [Steven Booth-Butterfield’s website](#). Humor orientation is the use of jokes and joking during interactions with other people. In this study, the researchers had Person 1 complete the Humor Orientation (HO) Scale (self-reported HO) and had Person 2 complete the HO about Person 1 (other-reported HO).

Positive

One of the first significant findings in this study was a positive relationship between someone’s perception of another person’s humor orientation (other-reported HO) and their popularity (social attractiveness). The term “positive relationship” here simply means that as someone’s score on the HO measure went up (people were seen as using more jokes and joking during their interactions with others), the more popular they were viewed by other people. In a positive relationship, the opposite is also true. People who were not viewed as using jokes and joking during their interactions were viewed as less popular by others. In essence, in a positive relationship as scores on one measure go up, the scores on the other measure go up. As scores on one measure go down, then scores on the other measure go down.

Negative

The second type of relationship we find using statistics is called a negative relationship. A negative relationship occurs when scores on one variable go up and scores on the second variable go down. In the Wanzer and Booth-Butterfield study, the researchers found that people who viewed themselves as having a strong humor orientation (higher scores on the HO scale) reported lower levels of loneliness. As scores for someone’s HO went up, then scores for reported loneliness went down. Again, the opposite is also true. As someone’s HO went down, their scores for reported loneliness went up.

No Relationship

The final type of relationship regularly found in research by interpersonal communication scholars is no relationship between two variables. In essence, not finding a relationship between variables means that, as scores on one measure went up, scores on the second measure didn’t go up or down at all. Most interesting in the Wanzer and Booth-Butterfield study was when they found no relationship between an individual’s rating of their HO (self-reported HO) and someone else’s perception of their social attractiveness (popularity). In essence, you can think you’re the funniest person in the world, but it will not relate to someone else’s perceptions of social attractiveness.

Note of Caution

Now that we’ve explained the three basic types of relationships commonly discussed in interpersonal communication research, we do want to raise one seriously important point. Correlation does not equal causation. The statistical test that we commonly use to examine relationships is called a correlation.

One of the inherent limitations of a correlation is that it cannot say that X caused Y. For example, in the Wanzer and Booth-Butterfield study, we cannot say that someone's HO caused them to be viewed as more popular. All we can tell when using a correlation is that there is a relationship or that there is not a relationship between two variables.

Differences

In addition to examining relationships, researchers are often highly interested in exploring what we call differences. Scholars distinguish between two types of differences: differences of kind and differences of degree.

Differences of Kind

Differences of kind are differences that exist because people fall within a specific category. The class example I always like to use is the behavioral differences between cheerleaders and football players. Cheerleaders will exhibit very specific behaviors (using megaphones, dancing, being tossed into the air, yelling cheers, pumping up the audience, etc.) during a football game. Football players will exhibit a very different set of behaviors (e.g., throwing the football, running with the football, kicking the football, tackling people). When you have two groups that have very different prescribed sets of behavior, we call this a difference of kind.

Differences of Degree

The difference that social scientists are most interested in is called differences of degree. The term “degree” here means that you are looking and comparing the scores of two different groups on a single variable. Let's take the concept of height and compare females and males. In a study completed by Max Roser, Cameron Appel, and Hannah Ritchie, the researchers examined a wide range of issues related to human height.⁴ Based on data that was gathered from 1896 until 1996, the researchers found that consistently males were taller than females. By 1996, males had an average height of 171 centimeters, while females had an average height of 159 centimeters. This difference is what we call a difference of degree.

Now, it's essential to realize that when we're discussing differences of degrees, we are comparing two or more groups' scores on a single outcome variable (in this case height). At the same time, just because we find that the average male is taller than the average female does not mean that there are not really short males and really tall females. In fact, research has shown us that there is generally a much broader range of heights among males than there is between males and females. The same is also true for females; there is a broad range of different heights of females. However, differences of degrees are not interested in the really short males or really tall females (or really tall males and really short females). Instead, differences of degrees are examined by looking at the average male's height and comparing it to the average female's height.

So, there you have it. You've now learned two very important concepts related to the statistics interpersonal communication scholars commonly use.

A Note for Professors

We want to start by thanking you for adopting this Open Educational Resource textbook. We know that

you have many different textbook options available to you today. We hope that you find this book to be both very student-friendly and scholarly-based. Our goal with this project was to create a textbook that could compete with the costly texts currently on the market. Interpersonal communication is one of the most commonly taught courses within the field, so we realized that a massive need existed for a textbook that could be highly competitive and freely available.

If you haven't asked for access to the instructor materials available for this book, please check out the Open SUNY Textbooks website to request access. We understand that instructors' resources are vital, so we created a comprehensive instructor's manual that includes note outlines, activities, and a test bank. Furthermore, a full set of PowerPoint presentations are freely available. Lastly, if you didn't adopt the student workbook at the same time you decided to adopt this book, we would highly encourage you to do so. The student workbook, which is also free, is aligned with the teaching notes, which makes for a cohesive set of items.

About the Authors

Jason S. Wrench

JASON S. WRENCH (Ed.D., West Virginia University) is a professor in the Department of Communication at the State University of New York at New Paltz. Dr. Wrench specializes in workplace learning and performance, or the intersection of instructional communication and organizational communication. His varied research interests include workplace learning and human performance improvement, computer-mediated communication, interpersonal communication, empirical research methods, family communication, humor, risk/crisis communication, and supervisor-subordinate interactions. Dr. Wrench regularly consults with individuals and organizations on workplace communication and as a professional speech coach for senior executives.

Dr. Wrench has published numerous books on a variety of communication topics: *Intercultural Communication: Power in Context* (2000), *Communication, Affect, and Learning in the Classroom* (2000, 2020), *Principles of Public Speaking* (2003, The College Network), *Human Communication in Everyday Life: Explanations and Applications* (2008, Allyn & Bacon), *Quantitative Research Methods for Communication: A Hands-On Approach* (2008, 2013, 2016, 2019, Oxford University Press), *The Directory of Communication Related Mental Measures* (2010, National Communication Association), *Stand Up, Speak Out: The Practice and Ethics of Public Speaking* (2011, 2016, Flat World Knowledge), *Communication Apprehension, Avoidance, and Effectiveness* (2013, Allyn & Bacon), *Organizational Communication: Theory, Research, and Practice* (2014, Flat World Knowledge), and *Training and Development: The Intersection of Communication and Talent Development in the Modern Workplace* (2014, Kendall Hunt). Dr. Wrench also edited or coedited: *The Impact of Social Media in Modern Romantic Relationship* (2017, Lexington), *Casing Organizational Communication* (2011, Kendall Hunt), *Workplace Communication for the 21st Century: Tools and Strategies that Impact the Bottom Line: Vol. 1. Internal Workplace Communication, Vol. 2. External Workplace Communication* (2013, both with Praeger), *Casing Public Relations* (2014, Kendall Hunt), and *Casing Sport Communication* (2015, Kendall Hunt). Dr. Wrench was the editor of the *Ohio Communication Journal* from 2005-2007, served as an associate editor for *Communication Research Reports* from 2007-2010, and has been on the editorial board for numerous academic journals. Furthermore, Dr. Wrench has published over 30 research articles that have appeared in various journals: *Communication Education*, *Communication Quarterly*, *Communication Research Reports*, *Education*, *Human Communication*, *Journal of Homosexuality*, *Journal of Intercultural Communication*, *Mentor*, *Southern Communication Journal*, *The Source: A Journal of Education*, and *The*

NACADA Journal (National Association of Campus Advising). Dr. Wrench is the former president of the Eastern Communication Association, and currently serves as the editor of the *Journal of Intercultural Communication Research* for the World Communication Association.

Narissra M. Punyanunt-Carter

NARISSRA M. PUNYANUNT-CARTER (Ph.D., Kent State University) is a professor in the Department of Communication and assistant dean of international affairs for the College of Media and Communication. She is also an associate professor of Communication Studies at Texas Tech University in Lubbock, Texas. She teaches the basic interpersonal communication course. Her research areas include mass media effects, father-daughter communication, mentoring, advisor-advisee relationships, family studies, religious communication, humor, and interpersonal communication. She has published over 70 articles that have appeared in several peer-reviewed journals, such as *Communication Research Reports*, *Southern Journal of Communication*, and *Journal of Intercultural Communication Research*. She has also published numerous instructional ancillaries and materials. She is also a coauthor of *Organizational communication: Theory, Research, and Practice* (2014, Flat World Knowledge). Dr. Punyanunt coedited *The Impact of Social Media in Modern Romantic Relationship* (2017, Lexington).

Katherine S. Thweatt

KATHERINE S. THWEATT (Ed.D, West Virginia University) is an associate professor at the State University of New York at Oswego. Dr. Thweatt's areas of interest are interpersonal communication, instructional communication, and health communication. She has published in the areas of teasing, teacher immediacy and misbehaviors, cognitive flexibility, and healthcare research. Healthcare publications involved shared medical appointments, heart failure, and infectious disease.

Dr. Thweatt has earned grant funding in the areas of diabetes and the theory of planned behavior, undergraduate research, and employer expectations. She earned two national best practice awards from URAC and the Pharmacy Benefits Management Institute while serving as the Senior Manager of Clinical Quality at the third-largest Medicare Part D sponsor. Dr. Thweatt serves on the editorial Board of *Communication Research Reports*, *Communication Education*, and *Communication Teacher*. She proudly contributes to her field through conference planning, serving as Marketing Director to the Eastern Communication Association and the Eastern Communication Association's Representative to the National Communication Association's Nominating Committee and as the 2019-2020 President of the Eastern Communication Association.

References

- 1 Schutz, W. C. (1960). *FIRO: A three dimensional theory of interpersonal behavior*. Holt, Rinehart & Winston.
- 2 Floyd, K., & Morman, M. T. (1998). The measurement of affectionate communication. *Communication Quarterly*, 46(2), 144-162. <https://doi.org/10.1080/01463379809370092>
- 3 Wanzer, M. B., & Booth-Butterfield, M. (1996). Are funny people popular? An examination of humor orientation, loneliness, and social attraction. *Communication Quarterly*, 44(1), 42-52. <https://doi.org/10.1080/01463379609369999>
- 4 Roser, M., m, C., & Ritchie, H. (2019, May). Human height. *Our World in Data*. <https://ourworldindata.org/human-height>

Acknowledgements

We want to thank our individual departments for keeping us writing, and giving us the time and space to create this Open Educational Resource.

We want to thank Allison Brown, SUNY Geneseo—Digital Publishing Services Manager, who helped us taking this project through the SUNY Open Educational Resources Process.

Lastly, we want to thank the proofreaders/editors who graciously gave of their time to read this book and make it better:

Carrie Owens
Leanne Page
Rebecca Ford
Erin Owens
Jennifer DeVito

day message process family like
Now might relationships back
interpersonal group two
one first
many mindful people public
think
new etc communication
symbol mediated mindfulness
way time may others awareness
communicate use communicators

CHAPTER 1

Introduction to Human Communication

If you're like most people taking their first course or reading your first book in interpersonal communication, you may be wondering what it is that you're going to be studying. Academics are notorious for not agreeing on definitions of concepts, which is also true of interpersonal communication scholars. Bochner laid out the fundamental underpinnings of this academic area called "interpersonal communication," "at least two communicators; intentionally orienting toward each other; as both subject and object; whose actions embody each other's perspectives both toward self and toward other."¹ This simplistic definition of interpersonal communication frustrates many scholars because it does not provide clear parameters for the area of study beyond two people interacting. Mark Knapp and John Daly noted that four areas of contention are commonly seen in the discussion of interpersonal communication: number of communicators involved, physical proximity of the communicators, nature of the interaction units, and degree of formality and structure.²

Number of Communicators Involved

As the definition from Bochner in the previous paragraph noted, most scholars agree that interpersonal communication involves “at least two communicators.” Although a helpful tool to separate interpersonal communication from small group or organizational communication, some scholars argue that looking specifically at one dyad is an accurate representation of interpersonal. For example, if you and your dating partner are talking about what a future together might look like, you cannot exclude all relational baggage that comes into that discussion. You might be influenced by your own family, friends, coworkers, and other associates. So although there may be only two people interacting at one point, there are strong influences that are happening in the background.

Physical Proximity of the Communicators

In a lot of early writing on the subject of interpersonal communication, the discussion of the importance of physical proximity was a common one. Researchers argued that interpersonal communication is a face-to-face endeavor. However, with the range of mediated technologies we have in the 21st Century, we often communicate interpersonally with people through social networking sites, text messaging,



Figure 1.1 Interpersonal Communication

“Interpersonal Communication.” by Bovee and Thill. This file is licensed under the Creative Commons Attribution 2.0 Unported license.

email, the phone, and a range of other technologies. Is the interaction between two lovers as they break up via text messages any less “interpersonal” than when the break up happens face-to-face? The issue of proximity is an interesting one, but we argue that in the 21st Century, so much of our interpersonal interactions do use some kind of technology.

Nature of the Interaction Units

One of our primary reasons for communicating with other people is trying to understand them and how and why they communicate. As such, some messages may help us understand and predict how people will behave and communicate, so do those interactions have a higher degree of “interpersonalness?”

Imagine you and your boyfriend or girlfriend just fought. You are not sure what caused the fight in the first place. During the ensuing conversation (once things have settled down), you realize that your boyfriend/girlfriend feels that when you flirt with others in public, it diminishes your relationship. Through this conversation, you learn how your behavior causes your boyfriend/girlfriend to get upset and react angrily. You now have more information about how your boyfriend/girlfriend communicates and what your behavior does to cause these types of interactions. Some would argue this type of conversation has a high degree of

“interpersonalness.” On the other hand, if you “like” a stranger’s post on Facebook, have you engaged in interpersonal communication? Is this minimal form of interaction even worth calling interpersonal communication?

Degree of Formality and Structure

The final sticking point that many scholars encounter when discussing interpersonal communication are the issues of formality and structure. A great deal of research in interpersonal communication has focused on interpersonal interactions that are considered informal and unstructured (e.g., friendships, romantic relationships, family interactions). However, numerous interpersonal interactions do have a stronger degree of formality and structure associated with them. For example, you would not interact with your physician the same way you would with your romantic partner because of the formality of that relationship. We often communicate with our managers or supervisors who exist in a formal organizational structure. In all of these cases, we are still examining interpersonal relationships.

1.1 Why Study Communication?

LEARNING OUTCOMES

1. Understand communication needs.
2. Discuss physical needs.
3. Explain identity needs.
4. Describe social needs.
5. Elucidate practical needs.

Most people think they are great communicators. However, very few people are “naturally” good. Communication takes time, skill, and practice. To be a great communicator, you must also be a great listener. It requires some proficiency and competence. Think about someone you know that is not a good communicator. Why is that person not good? Do they say things that are inappropriate, rude, or hostile? This text is designed to give you the skills to be a better communicator.

Reasons to Study Communication

We need to study communication for a variety of reasons. First, it gives us a new perspective on something we take for granted every day. As stated earlier, most people think they are excellent communicators. However, most people never ask another person if they are great communicators. Besides being in a public speaking class or listening to your friends’ opinions, you probably do not get a lot of feedback on the quality of your communication. In this book, we will learn all about communication from different perspectives. As the saying goes, “You can’t see the forest for the trees.” In other words, you won’t be able to see the impact of your communication behaviors, if you don’t focus on certain communication aspects. The second reason we study communication is based on the quantity of our time that is devoted to that activity. Think about your daily routine; I am sure that it involves communicating with others (via face-to-face, texting, electronic media, etc.). Because we spend so much of our time communicating with others, we should make that time worthwhile. We need to

learn how to communicate and communicate better because a large amount of our time is allotted to communicating with others. The last reason why we study communication is to increase our effectiveness. Marriages and relationships often fail for several reasons. The most popular reason is that people don't know how to communicate with each other, which leads to irreconcilable differences. People often do not know how to work through problems, and it creates anger, hostility, and possibly violence. In these cases, communication needs to be effective for the relationship to work and be satisfying. Think about all the relationships that you have with friends, family, coworkers, and significant others. This course could possibly make you more successful in those relationships.

We all have specific and general reasons why we communicate with others. They vary from person to person. We know that we spend a large amount of our time communicating. Also, every individual will communicate with other people. Most people do not realize the value and importance of communication. Sherry Morreale and Judy Pearson believe that there are three main reasons why we need to study communication.³ First of all, when you study communication behaviors, it gives you a new perspective on something you probably take for granted. Some people never realize the important physiological functions until they take a class on anatomy or biology. In the same fashion, some people never understand how to communicate and why they communicate until they take a communication studies course. Second, we need to study communication because we spend a large portion of our time communicating with other people. Gina Chen found that many people communicate online every day, and Twitter subscribers fulfill their needs of camaraderie by tweeting with others.⁴ Hence, we all need to communicate with others. Third, the most important reason is to become a better communicator. Research has shown that we need to learn to communicate better with others because none of us are very good at it.

Communication Needs

Think for a minute of all the problematic communication behaviors that you have experienced in your life: personally or professionally. You will probably notice that there are areas that could use improvement. In this book, we will learn about better ways to communicate. To improve your communication behaviors, you must first understand the needs for communicating with others.

Physical

Studies show that there is a link between mental health and physical health. In other words, people who encounter negative experiences, but are also willing to communicate those experiences are more likely to have better mental and physical health.⁵ Ronald Adler, Lawrence Rosenfeld, and Russell Proctor found that communication has been beneficial to avoiding or decreasing:⁶

- Stress
- Anxiety
- Depression
- Cancer
- Coronary problems
- Common Cold

Research clearly illustrates that communication is vital for our physical health. Because many health problems are stress-induced, communication offers a way to relieve this tension and alleviate some of the

physical symptoms. It is vital for people to share what they feel, because if they keep it bottled up, then they are more likely to suffer emotionally, mentally, and physically.

Identity

Communication is not only essential for us to thrive and live. It is also important to discover who we are. From a very young age, you were probably told a variety of characteristics about your physical appearance and your personality. You might have been told that you are funny, smart, pretty, friendly, talented, or insightful. All of these comments probably came from someone else. For instance, Sally went to a store without any makeup and saw one of her close friends. Sally's friend told her that she looked horrible without any makeup. So, from that day forward, she never walked out of the house without her cosmetics. You can see that this one comment affected Sally's behavior but also her perceptions about herself. Just one comment can influence how you think, act, and feel. Think about all the comments that you have been told in your life. Were they hurtful comments or helpful comments? Did they make you stronger or weaker? You are who you are based on what others have told you about yourself and how you responded to these comments. In another opposite example, Mark's parents told him that he wasn't very smart and that he would probably amount to nothing. Mark used these comments to make himself better. He studied harder and worked harder because he believed that he was more than his parents' comments. In this situation, you can see that the comments helped shape his identity differently in a positive manner.

Social

Other than using words to identify who we are, we use communication to establish relationships. Relationships exist because of communication. Each time we talk to others, we are sharing a part of ourselves with others. We know people have strong relationships with others due to the conversations that they have with others. Think about all the relationships that you are involved with and how communication differs in those relationships. If you stopped talking to the people you care about, your relationships might suffer. The only way relationships can grow is when communication occurs between individuals. Joy Koesten analyzed family communication patterns and communication competence. She found that people who grew up in more conversation oriented families were also more likely to have better relationships than people who grew up in lower conversation-oriented families.⁷

Practical

Communication is a key ingredient in our life. We need it to operate and do our daily tasks. Communication is the means to tell the barista what coffee you prefer, inform your physician about what hurts, and advise others that you might need help.

We know that communication helps in the business setting. Katherine Kinnick and Sabrena Parton maintained that communication is important in workplace settings. They found that the ability to persuade effectively was very important. Moreover, females are evaluated more on their interpersonal skills than males, and males were evaluated more on their leadership skills than interpersonal skills.⁸ Overall, we know that to do well in the business setting, one must learn to be a competent communicator.

Moreover, we know that communication is not only crucial in professional settings but in personal settings. Daniel Canary, Laura Stafford, and Beth Semic found that communication behaviors are essential in marriages because communication is essential for marriage longevity and success.⁹ In

another study, Laura Stafford and Daniel Canary illustrated the importance of communication in dating relationships.¹⁰ All in all, communication is needed for people to relate to others, build connections, and help our relationships exist.

Key Takeaways

- We need communication. We need to be able to study communication because we spend so much time doing it, we could learn to be more effective at it, and it is something we have done for a long time.
- Research has shown us that communication can help us with physical needs. When we are hungry or thirsty, we can tell someone this, but also it helps to release stress.
- To maintain, create, or terminate relationships, we need communication. Communication helps fulfill our social needs to connect with others.
- To function, we need communication for practical needs.

Exercises

- Think of an example for each communication need. Which need is most important for you? Why?
- Why do you think it is important to study communication? Is this class required for you? Do you think it should be a requirement for everyone?
- Think about how your identity has been shaped by others. What is something that was said to you that impacted how you felt? How do you feel now about the comment?

1.2 Basic Principles of Human Communication

LEARNING OUTCOMES

1. Define and explain the term “communication.”
2. Describe the nature of symbols and their importance to human communication.
3. Explain seven important factors related to human communication.

The origin of the word **communication** can be traced back to the Latin word *communico*, which is translated to mean “to join or unite,” “to connect,” “to participate in” or “to share with all.” This root word is the same one from which we get not only the word *communicate*, but also *common*, *commune*, *communion*, and *community*. Thus, we can define communication as a process by which we share ideas or

information with other people. We commonly think of communication as talking, but it is much broader than just speech. Other characteristics of voice communicate messages, and we communicate, as well, with eyes, facial expressions, hand gestures, body position, and movement. Let us examine some basic principles about how we communicate with one another.

Communication Is Symbolic

Have you ever noticed that we can hear or look at something like the word “cat” and immediately know what those three letters mean? From the moment you enter grade school, you are taught how to recognize sequences of letters that form words that help us understand the world. With these words, we can create sentences, paragraphs, and books like this one. The letters used to create the word “cat” and then the word itself is what communication scholars call symbols. A **symbol** is a mark, object, or sign that represents something else by association, resemblance, or convention.

Let’s think about one of the most important words commonly tossed around, love. The four letters that make up the word “l,” “o,” “v,” and “e,” are visual symbols that, when combined, form the word “love,” which is a symbol associated with intense regard or liking. For example, I can “love” chocolate. However, the same four-letter word has other meanings attached to it as well. For example, “love” can represent a deeply intimate relationship or a romantic/sexual attachment. In the first case, we could love our parents/guardians and friends, but in the second case, we experience love as a factor of a deep romantic/sexual relationship. So these are just three associations we have with the same symbol, love. In Figure 1.2, we see American Sign Language (ASL) letters for the word “love.” In this case, the hands themselves represent symbols for English letters, which is an agreed upon convention of users of ASL to represent “love.”

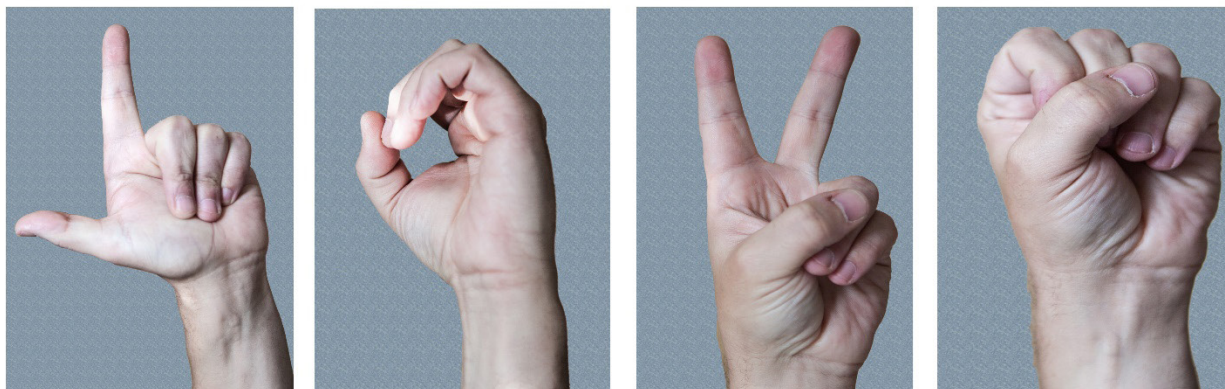

Figure 1.2 Child Using ASL to Sign Love

“love.” By David Pacey. This file is licensed under the [Creative Commons Attribution 2.0 Unported](#) license.

Symbols can also be visual representations of ideas and concepts. For example, look at the symbols in Figure 1.3 of various social media icons. In this image, you see symbols for a range of different social media sites, including Facebook (lowercase “f”), Twitter (the bird), Snap Chat (the ghost image), and many others. Admittedly, the icon for YouTube uses its name.



Figure 1.3 Social Media Icons
“Social Media Mix 3D Icons - Mix #1.” by Blogtrepreneur. This file is licensed under the [Creative Commons Attribution 2.0 Unported](#) license.

The Symbol is Not the Thing

Now that we’ve explained what symbols are, we should probably offer a few very important guides. First, the symbol is not the thing that it is representing. For example, the word “dog” is not a member of the canine family that greets you when you come home every night. If we look back at those symbols listed in Figure 1.2, those symbols are not the organizations themselves. The “p” with a circle around it is not Pinterest. The actual thing that is “Pinterest” is a series of computer code that exists on the World Wide Web that allows us, people, to interact.

Arbitrariness of Symbols

How we assign symbols is entirely arbitrary. For example, in Figure 1.4, we see two animals that are categorized under the symbols “dog” and “cat.” In this image, the “dog” is on the right side, and the “cat” is on the left side. The words we associate with these animals only exist because we have said it’s so for many, many years. Back when humans were labeling these animals, we could just have easily called the one on the left “cat” and the one on the right “dog,” but we didn’t. If we called the animal on the left “cat,” would that change the nature of what that animal is? Not really. The only thing that would change is the symbol we have associated with that animal.



Figure 1.4 Dog and Cat
“Dog and cat.” by kitty.green66. This file is licensed under the [Creative Commons Attribution 2.0 Unported](#) license.

Let’s look at another symbolic example you are probably familiar with – :). The “smiley” face or the two pieces of punctuation (colon followed by closed parentheses) is probably the most notable symbol used in Internet communication. This symbol may seem like it’s everywhere today, but it’s only existed since September 1982. In early September 1982, a joke was posted on an electronic bulletin board about a fake chemical spill at Carnegie Mellon University. At the time, there was no easy way to distinguish

between serious versus non-serious information. A computer scientist named Scott E. Fahlman entered the debate with the following message:

The Original Emoticons

I propose that [sic] the following character sequence for joke markers:

:)

Read it sideways. Actually, it is probably more economical to mark things that are NOT jokes, given current trends. For this, use:

:(

Thus the first emoticon, a sequence of keyboard characters used to represent facial expressions or emotions, was born. Even the universal symbol for happiness, the yellow circle with the smiling face, had only existed since 1963 when graphic artist Harvey Ross Ball created it. The happy face was created as a way to raise employee morale at State Mutual Life Assurance Company of Worcester, Massachusetts. Of course, when you merge the happy face with emoticons, we eventually ended up with emojis (Figure 1.5).

Of course, many people today just take emojis for granted without ever knowing their origin at all.



Figure 1.5 Emojis

Communication Is Shared Meaning

Hopefully, in our previous discussion about symbols, you noticed that although the assignment of symbols to real things and ideas is arbitrary, our understanding of them exists because we agree to their meaning. If we were talking and I

said, “it’s time for tea,” you may think that I’m going to put on some boiling water and pull out the oolong tea. However, if I said, “it’s time for tea” in the United Kingdom, you would assume that we were getting ready for our evening meal. Same word, but two very different meanings depending on the culture within which one uses the term. In the United Kingdom, high tea (or meat tea) is the evening meal. Dinner, on the other hand, would represent the large meal of the day, which is usually eaten in the middle of the day. Of course, in the United States, we refer to the middle of the day meal as lunch and often refer to the evening meal as dinner (or supper).

Let’s imagine that you were recently at a party. Two of your friends had recently attended the same

Broadway play together. You ask them “how the play was,” and here’s how the first friend responded:

So, we got to the theatre 20 minutes early to ensure we were able to get comfortable and could do some people watching before the show started. The person sitting in front of us had the worst comb-over I had ever seen. Halfway through Act 1, the hair was flopping back in our laps like the legs of a spider. I mean, those strands of hair had to be 8 to 9 inches long and came down on us like it was pleading with us to rescue it. Oh, and this one woman who was sitting to our right was wearing this huge fur hat-turban thing on her head. It looked like some kind of furry animal crawled up on her head and died. I felt horrible for the poor guy that was sitting behind her because I’m sure he couldn’t see anything over or around that thing.

Here’s is how your second friend described the experience:

I thought the play was good enough. It had some guy from the UK who tried to have a Brooklyn accent that came in and out. The set was pretty cool though. At one point, the set turned from a boring looking office building into a giant tree. That was pretty darn cool. As for the overall story, it was good, I guess. The show just wasn’t something I would normally see.

In this case, you have the same experience described by two different people. We are only talking about the experience each person had in an abstract sense. In both cases, you had friends reporting on the same experience but from their perceptions of the experience. With your first friend, you learn more about what was going on around your friend in the theatre but not about the show itself. The second friend provided you with more details about her perception of the play, the acting, the scenery, and the story. Did we learn anything about the content of the “play” through either conversation? Not really.

Many of our conversations resemble this type of experience recall. In both cases, we have two individuals who are attempting to share with us through communication specific ideas and meanings. However, sharing meaning is not always very easy. In both cases, you asked your friends, “how the play was.” In the first case, your friend interpreted this phrase as being asked about their experience at the theatre itself. In the second case, your friend interpreted your phrase as being a request for her opinion or critique of the play. As you can see in this example, it’s easy to get very different responses based on how people interpret what you are asking.

Communication scholars often say that “meanings aren’t in words, they’re in people” because of this issue related to interpretation. Yes, there are dictionary definitions of words. Earlier in this chapter, we provided three different dictionary-type definitions for the word “love:” 1) intense regard or liking, 2) a deeply intimate relationship, or 3) a romantic/sexual attachment. These types of definitions we often call **denotative definitions**. However, it’s important to understand that in addition to denotative definitions, there are also **connotative definitions**, or the emotions or associations a person makes when exposed to a symbol. For example, how one personally understands or experiences the word “love” is connotative. The warm feeling you get, the memories of experiencing love, all come together to give you a general, personalized understanding of the word itself. One of the biggest problems that occur is when one person’s denotative meaning conflicts with another person’s connotative meaning. For example, when I write the word “dog,” many of you think of four-legged furry family members. If you’ve never been a dog owner, you may just generally think about these animals as members of the canine family.

If, however, you've had a bad experience with a dog in the past, you may have very negative feelings that could lead you to feel anxious or experience dread when you hear the word "dog." As another example, think about clowns. Some people see clowns as cheery characters associated with the circus and birthday parties. Other people are genuinely terrified by clowns. Both the dog and clown cases illustrate how we can have symbols that have different meanings to different people.

Communication Involves Intentionality

One area that often involves a bit of controversy in the field of communication is what is called intentionality. Intentionality asks whether an individual purposefully intends to interact with another person and attempt shared meaning. Each time you communicate with others, there is intentionality involved. You may want to offer your opinions or thoughts on a certain topic. However, intentionality is an important concept in communication. Think about times where you might have talked aloud without realizing another person could hear you. Communication can occur at any time. When there is intent among the parties to converse with each other, then it makes the communication more effective.

Others argue that you "cannot, not communicate." This idea notes that we are always communicating with those around us. As we'll talk more about later in this book, communication can be both verbal (the words we speak) and nonverbal (gestures, use of space, facial expressions, how we say words, etc.). From this perspective, our bodies are always in a state of nonverbal communication, whether it's intended or not. Maybe you've walked past someone's office and saw them hunched over at their desk, staring at a computer screen. Based on the posture of the other person, you decide not to say "hi" because the person looks like they are deep in thought and probably busy. In this case, we interpret the person's nonverbal communication as saying, "I'm busy." In reality, that person could just as easily be looking at Facebook and killing time until someone drops by and says, "hi."

Dimensions of Communication

When we communicate with other people, we must always remember that our communication is interpreted at multiple levels. Two common dimensions used to ascertain meaning during communication are relational and content.

Relational Dimension

Every time we communicate with others, there is a relational dimension. You can communicate in a tone of friendship, love, hatred, and so forth. This is indicated in how you communicate with your receiver. Think about the phrase, "You are crazy!" It means different things depending on the source of the message. For instance, if your boss said it, you might take it harsher than if your close friend said it to you. You are more likely to receive a message more accurately when you can define the type of relationship that you have with this person. Hence, your relationship with the person determines how you are more likely to interpret the message. Take another example of the words "I want to see you now!" These same words might mean different things if it comes from your boss or if it comes from your lover. You will know that if your boss wants to see you, then it is probably an urgent matter that needs your immediate attention. However, if your lover said it, then you might think that they miss you and can't bear the thought of being without you for too long.

Content Dimension

In the same fashion, every time we speak, we have a content dimension. The content dimension is the information that is stated explicitly in the message. When people focus on the content of a message, then ignore the relationship dimension. They are focused on the specific words that were used to convey the message. For instance, if you ran into an ex-lover who said “I’m happy for you” about your new relationship. You might wonder what that phrase means. Did it mean that your ex was truly happy for you, or that they were happy to see you in a new relationship, or that your ex thinks that you are happy? One will ponder many interpretations of the message, especially if a relationship is not truly defined.

Another example might be a new acquaintance who talks about how your appearance looks “interesting.” You might be wondering if your new friend is sarcastic, or if they just didn’t know a nicer way of expressing their opinion. Because your relationship is so new, you might think about why they decided to pick that term over another term. Hence, the content of a message impacts how it is received.

Communication Is a Process

The word “process” refers to the idea that something is ongoing, dynamic, and changing with a purpose or towards some end. A communication scholar named David K. Berlo was the first to discuss human communication as a process back in 1960.¹¹ We’ll examine Berlo’s ideas in more detail in Chapter 2, but for now, it’s important to understand the basic concept of communication as a process. From Berlo’s perspective, communication is a series of ongoing interactions that change over time. For example, think about the number of “inside jokes” you may have with your best friend. Sometimes you can get to the point where all you say is one word, and both of you can crack up laughing. This level of familiarity and short-hand communication didn’t exist when you first met but has developed over time. Ultimately, the more interaction you have with someone, the more your relationship with that person will evolve.

Communication Is Culturally Determined

The word culture refers to a “group of people who through a process of learning can share perceptions of the world that influences their beliefs, values, norms, and rules, which eventually affect behavior.”¹² Let’s breakdown this definition. First, it’s essential to recognize that culture is something we learn. From the moment we are born, we start to learn about our culture. We learn culture from our families, our schools, our peers, and many other sources as we age. Specifically, we learn perceptions of the world. We learn about morality. We learn about our relationship with our surroundings. We learn about our places in a greater society. These perceptions ultimately influence what we believe, what we value, what we consider “normal,” and what rules we live by. For example, many of us have beliefs, values, norms, and rules that are directly related to the religion in which we were raised. As an institution, religion is often one of the dominant factors of culture around the world.

Let’s start by looking at how religion can impact beliefs. Your faith can impact what you believe about the nature of life and death. For some, depending on how you live, you’ll either go to a happy place (Heaven, Nirvana, Elysium, etc.) or a negative place (Hell, Samsara, Tartarus, etc.). We should mention that Samsara is less a “place” and more the process of reincarnation as well as one’s actions and consequences from the past, present, and future.

Religion can also impact what you value. Cherokee are taught to value the earth and the importance of keep balance with the earth. Judaic religions (Judaism, Christianity, Islam, etc.), on the other hand, teach that humans have been placed on earth to dominate and control the earth. As such, the value is more on what the earth can provide than on ensuring harmony with nature.

Religion can also impact what you view as “normal.” Many adherents to Islam stress the importance of female modesty, so it is normal for women to cover their heads when in public or completely cover their entire bodies from head to toe. On the other hand, one branch of Raëlianism promotes a pro-sex feminist stance where nudity and sex work are normal and even celebrated.

Different religions have different rules that get created and handed down. For most Western readers, the most famous set of rules is probably the Judaic Tradition’s Ten Commandments. Conversely, Hindus have a text of religious laws transmitted in the Vedas. Most major religions have, at some point or another, had religious texts that became enshrined laws within those societies.

Finally, these beliefs, values, norms, and rules ultimately impact how all of us interact and behave with others. For example, because of the Islamic rules on and norms about female modesty, in many Islamic countries, women cannot speak with men unless they are directly related to them by birth or marriage. The critical part to remember about these actual behaviors is that we often have no idea how (and to what degree) our culture influences our communicative behavior until we are interacting with someone from a culture that differs from ours. We’ll talk more about issues of intercultural interpersonal interactions later in this text.

Communication Occurs in a Context

Another factor that influences how we understand others is the context, the circumstance, environment, setting, and/or situation surrounding an interaction. Most people learning about context are generally exposed during elementary school when you are trying to figure out the meaning of a specific word. You may have seen a complicated word and been told to use “context clues” to understand what the word means. In the same vein, when we analyze how people are communicating, we must understand the context of that communication.

Imagine you’re hanging out at your local restaurant, and you hear someone at the next table say, “I can’t believe that guy. He’s always out in left field!” As an American idiom, we know that “out in left field” generally refers to something unexpected or unusual. The term stems out of baseball because the player who hangs out in left field has the farthest to throw to get a baseball back to the first baseman in an attempt to tag out a runner. However, if you were listening to this conversation in farmland, you could be hearing someone describe a specific geographic location (e.g., “He was out in left field chasing after a goat who stumbled that way”). In this case, context does matter.

Communication Is Purposeful

We communicate for different reasons. We communicate in an attempt to persuade people. We communicate to get people to like us. We communicate to express our liking of other people. We could list different reasons why we communicate with other people. Often we may not even be aware of the specific reason or need we have for communicating with others. We’ll examine more of the different needs that communication fulfills along with the motives we often have for communicating with others in Chapter 2.

Key Takeaways

- Communication is derived from the Latin root *communico*, which means to share.

- As communicators, each time we talk to others, we share part of ourselves.
- Symbols are words, pictures, or objects that we use to represent something else. Symbols convey meanings. They can be written, spoken, or unspoken.
 - There are many aspects to communication. Communication involves shared meaning; communication is a process; has a relationship, intent, & content dimension; is culturally determined, occurs in context; and is purposeful.

Exercises

- In groups, provide a real-life example for each of these aspects: Communication involves shared meaning, communication is a process, has a relationship, intent, & content dimension, occurs in a context, is purposeful, and is culturally defined.
- As a class, come up with different words. Then, divide the class and randomly distribute the words. Each group will try to get the other group to guess their words either by drawing symbols or displaying nonverbal behaviors. Then discuss how symbols impact perception and language.
- Can you think of some examples of the Sapir-Whorf hypothesis? For instance, in Japan, the word “backyard” does not exist. Because space is so limited, most Japanese people do not have backyards. This term is foreign to them, but in America, most of our houses have a backyard.

1.3 Communication Competence

LEARNING

OUTCOMES

1. Explain competence.
2. Distinguish between social appropriateness and personal effectiveness and their relationship to communication competence.
3. Identify characteristics of competence.

Defining Competence

Brian Spitzberg (2000) argued that **communication competence** involved being both appropriate and effective.¹³ **Appropriate** communication is what most people would consider acceptable behaviors. **Effective** communication is getting your desired personal outcome.

You might think about communicators who were appropriate but not effective and vice versa. The two characteristics go hand in hand. You need to have both to be considered competent. Think about coaches who might say horrible or inappropriate things to their players to motivate them. This may be viewed as highly effective to some, but possibly very inappropriate to others. Especially if you are not

used to harsh language or foul language, then your perceptions could hinder how you feel about the speaker. At the same time, you might have individuals that are highly appropriate but are not effective. They may say the right things, but cannot get any results. For instance, imagine a mother who is trying over and over to get her child to brush their teeth. She might try praises or persuasive techniques, but if the child doesn't brush their teeth, then she is not accomplishing her goal. You truly need a balance between the two.

Understanding Competence

First of all, no one way of communicating will be best or most effective for everyone.. Think about the speakers that you know. Perhaps, some are more charismatic, humorous, assertive, and timid than others. Just as there are many types of speakers and speaking styles, there are different types of competent communicators. For example, a joke in one context might be hilarious, but that same joke might be very offensive in another context. What this tells us is that there is no guaranteed or definite method that will work in every situation. Communication that works in one context and not another depends on the culture and the characteristics of the person or persons receiving the message.

Moreover, we know that communication varies from one context to another. For instance, kindergarten teachers may be wonderful in a room full of five-year-olds, but if you asked them to present in a college classroom, they might get a little nervous because the situation is different. Some situations are better for certain speakers than others. Some people can rise to the occasion and truly deliver a memorable speech in a moment of crisis. However, if you asked them to do it again, they might not be able to do so because of the situational variables that influenced the speech. Some individuals are wonderful public speakers but are truly unable to communicate in interpersonal relationships and vice versa. These situations occur because some people feel more comfortable in certain settings than others. Hence, competency can vary depending on the type of communication.

Also, competence can be taught. The main reason why taking a communication course is so important is to be a better speaker. Hence, this is why many schools make it a requirement for college students. Think about an invention or idea you might have. If you can't communicate that idea or invention, then it will probably never come to fruition.

Characteristics of Competence

Now that you know more about competence, it is important to note that competent communicators often share many similar characteristics. Studies on competence illustrate that competent communicators have distinctive characteristics that differ from incompetent communicators. We will discuss a few of these characteristics in this section.

Skillful

First, many competent communicators are skillful. In other words, they use situational cues to figure out which approach might be best. Think about a car salesperson and about how she/he will approach a customer who is wanting to make a purchase. If the salesperson is too aggressive, then they might lose a sale. For that reason, they need to cater to their customer and make sure that they meet their customer's needs. The salesperson might directly approach the customer by simply saying, "Hi I'm Jamie, I would be happy to help you today," or by asking questions like, "I see you looking at cars today. Are you interested in a particular model?" , or they could ask the customer to talk more by saying, "Can you tell

me more about what you are looking for?” And perhaps, a salesperson could even compliment the customer. Each of these strategies illustrates how a salesperson can be skillful in meeting the customer’s expectations and, at the same time, fulfilling their own goals. Just like a chef has many ingredients to use to prepare a dish, a competent communicator possesses many skills to use depending on the situation.

Adaptable

Second, competent communicators are adaptable. I am sure you might have seen a speaker who uses technology like PowerPoint to make their presentations. What happens if technology fails, does the speaker perform poorly as well? Competent communicators would not let technology stop them from presenting their message. They can perform under pressure and any type of constraint. For instance, if the communicator is presenting and notices that the audience has become bored, then they might change up their presentation and make it more exciting and lively to incite the audience.

Involved

Third, competent communicators can get others involved. Competent communicators think about their audience and being understood. They can get people excited about a cause or effort and create awareness or action. Think about motivational speakers and how they get people encouraged to do something. Competent communicators are also persuasive; they have the skill to involve their audience to do something such as protest, vote, or donate. Think about politicians who make speeches and provide so many interesting statements that people are more inclined to vote in a certain direction.

Understands Their Audience

Fourth, competent communicators can understand their audience. Keeping with the same example of politicians, many of them will say things like, “I know what it is like not to be able to feed your family, to struggle to make ends meet, or not to have a job. I know what you are going through. I understand where you are coming from.” These phrases are ways to create a bond between the speaker and the receiver of the message. Competent communicators can empathize and figure out the best way to approach the situation. For instance, if someone you know had a miscarriage and truly has wanted to have kids for a long time, then it would probably be very inconsiderate to say, “just try again.” This comment would be very rude, especially if this person has already tried for a long time to have a child. A competent communicator would have to think about how this person might feel and what words would genuinely be more appropriate to the situation.

Cognitive Complexity

Fifth, knowing how to say the same thing in different ways is called **cognitive complexity**. You might think that the only way to express affection would be to say, “I love you” or “I care about you.” What other ways could you express affection? This skill is being cognitively complex. Think about a professor you might have had that used different methods to solve the same problem. Your professor might say, “To solve this problem, you might try method A, and if that doesn’t work, you could try method B, and method C is still another way.” This illustrates that you don’t have to say things one way, you could say it in different ways. This helps your audience understand your message better because you provided different ways to comprehend your intended message.

Self-Monitoring

The last characteristic of competent communicators is the ability to monitor yourself. Also known as **self-monitoring**. This is the ability to focus on your behavior, and, in turn, determine how to behave in the situation. In every speaking situation, most people will have an internal gauge of what they might say next or not say. Some people never give any thought to what they might say to others. These individuals would have low self-monitoring skills, in which what you see is what you get. You could have high self-monitors that pay attention to every little thing, how they stand, where their eyes move, how they gesture, and maybe even how they breathe. They pay attention to these minor details because they are concerned with how the message might come across to others. Competent communicators have a balance of high and low self-monitoring, in which they realize how they might be perceived, but they are not overly focused on all the details of themselves.

Key Takeaways

- Competence involves being both appropriate and effective.
- Appropriateness refers to communicative behaviors that are socially acceptable behaviors; whereas, effectiveness refers to communicative behaviors that help achieve a desired outcome.
- Characteristics of competence involve skill, adaptability, involvement, complexity, and empathy.

Exercises

- Who do you think are competent/incompetent communicators? Why?
- How would you rate yourself as a competent speaker? Give a brief impromptu speech, then ask someone to rate you based on the characteristics of competence. Do you agree? Why or why not?
- Using cognitive complexity skills, think about all the ways you can express affection/hatred. Talk about how these ways would be interpreted by others - positively/negatively and why? Does it matter if the other person was a different sex, culture, gender, ethnicity, age, or religion? How and why

1.4 Types of Human Communication

LEARNING

OUTCOMES

1. Define and explain intrapersonal communication.
2. Define and explain interpersonal communication.
3. Define and explain small group communication.
4. Define and explain public communication.
5. Define and explain mediated communication.



Figure 1.6 Levels of Communication

Intrapersonal Communication

Intrapersonal communication refers to communication phenomena that exist within or occur because of an individual's self or mind. Some forms of intrapersonal communication can resemble a conversation one has with one's self. This "self-talk" often is used as a way to help us make decisions or make sense of the world around us. Maybe you've gone to the grocery store, and you're repeating your grocery list over and over in your head to make sure you don't forget anything. Maybe at the end of the day, you keep a diary or journal where you keep track of everything that has happened that day. Or perhaps you're having a debate inside your head on what major you should pick. You keep weighing the pros and cons of different majors, and you use this internal debate to help you flesh out your thoughts and feelings on the subject. All three of these examples help illustrate some of what is covered by the term "intrapersonal communication."

Today scholars view the term “intrapersonal communication” a little more broadly than just the internal self-talk we engage in. Communication scholar Samuel Riccillo primarily discusses intrapersonal communication as a factor of biology.¹⁴ Under this perspective, we must think about the biological underpinnings of how we can communicate. The human brain is probably the single most crucial physiological part of human interactions. We know that how people communicate can be greatly impacted by their brains. As such, our definition of intrapersonal communication is broad enough to include both traditional discussions of self-talk and more modern examinations of how the human body helps or hinders our ability to communicate effectively.

Interpersonal Communication

Interpersonal communication, which is what this book is all about, focuses on the exchange of messages between two people. Our days are full of interpersonal communication. You wake up, roll over, and say good morning to your significant other, then you’ve had your first interpersonal interaction of the day. You meet your best friend for coffee before work and discuss the ins and outs of children’s lives; you’re engaging in interpersonal communication again. You go to work and collaborate with a coworker on a project; once again, you’re engaging in interpersonal communication. You then shoot off an email to your babysitter, reminding him to drop by the house at seven so you and your partner can have a night out. Yep, this is interpersonal communication, too. You drop by your doctor’s office for your annual physical, and the two of you talk about any health issues; this is also a form of interpersonal communication. You text your child to remind him that he has play practice at 5:00 pm and then needs to come home immediately afterward; you’ve engaged in interpersonal interaction. Hopefully, you’re beginning to realize that our days are filled with tons of interpersonal interactions.

Some scholars also refer to interpersonal communication as dyadic communication because it involves two people or a dyad. As you saw above, the type of dyad can range from intimate partners, to coworkers, to doctor-patient, to friends, to parent-child, and many other dyadic partnerships. We can engage in these interactions through verbal communication, nonverbal communication, and mediated communication. When we use words during our interaction to convey specific meaning, then we’re engaging in verbal communication. Nonverbal communication, on the other hand, refers to a range of other factors that can impact how we understand each other—for example, the facial expressions you have. You could be talking to your best friend over coffee about a coworker and “his problems” while rolling your eyes to emphasize how overly dramatic and nonsensical you find the person. A great deal of how we interpret the verbal message of someone is based on the nonverbal messages sent at the same time. Lastly, we engage in interpersonal interactions using mediated technologies like the cellphone, emailing, texts, Facebook posts, Tweets, etc. Your average professional spends a great deal of her day responding to emails that come from one person, so the email exchange is a form of interpersonal communication.

Small Group Communication

The next type of communication studied by communication scholars is small group communication. Although different scholars will differ on the exact number of people that make a group, we can say that a **group** is at least three people interacting with a common goal. Sometimes these groups could be as large as 15, but larger groups become much harder to manage and end up with more problems. One of the hallmarks of a small group is the ability for all the group members to engage in interpersonal interactions

with all the other group members.

We engage in small groups throughout our lives. Chances are you've engaged in some kind of group project for a grade while you've been in school. This experience may have been a great one or a horrible one, depending on the personalities within the group, the ability of the group to accomplish the goal, the in-fighting of group members, and many other factors. Whether you like group work or not, you will engage in many groups (some effective and some ineffective) over your lifespan. We're all born into a family, which is a specific type of group relationship. When you were younger, you may have been in play-groups. As you grew older, you had groups of friends you did things with. As you enter into the professional world, you will probably be on some kind of work "team," which is just a specialized type of group. In other words, group communication is a part of life.

Public Communication

The next category of communication is called public communication. **Public communication** occurs when an individual or group of individuals sends a specific message to an audience. This one-to-many way of communicating is often necessary when groups become too large to maintain interactions with all group members. One of the most common forms of public communication is public speaking. As I am writing this chapter, we are right in the middle of the primary season for the 2020 Presidential election. People of all political stripes have been attending candidate speeches in record-breaking numbers this year.

The size of the audience one speaks to will impact how someone delivers a speech. If you're giving a speech to ten people, you'll have the ability to watch all of your audience members and receive real-time feedback as people nod their heads in agreement or disagreement. On the other hand, if you're speaking to 10,000+ people at once, a speaker cannot watch all of their audience members and get feedback. With a smaller audience, a speaker can adapt their message on the fly as they interpret audience feedback. With a larger audience, a speaker is more likely to deliver a very prepared speech that does not alter based on individual audience members' feedback. Although this book is not a public speaking book, we would recommend that anyone take a public speaking class, because it's such an essential and valuable skill in the 21st Century. As we are bombarded with more and more messages, being an effective speaker is more important today than ever before.

Mediated Communication

The final type of communication is **mediated communication**, or the use of some form of technology to facilitate information between two or more people. We already mentioned a few forms of mediated communication when we talked about interpersonal communication: phone calls, emails, text messaging, etc. In each of these cases, mediated technology is utilized to facilitate the share of information between two people.

Most mediated communication occurs because technology functions as the link between someone sending information and someone receiving information. For example, you go online and look up the statistics from last night's baseball game. The website you choose is the link between you and the reporter who authored the information. In the same way, if you looked up these same results in a newspaper, the newspaper would be the link between you and the reporter who wrote the article. The technology may have changed from print to electronic journalism, but the basic concept is still very much alive.

Today we are surrounded by a ton of different media options. Some common examples include

cable, satellite television, the World Wide Web, content streaming services (i.e., Netflix, Hulu, etc.), social media, magazines, voice over internet protocol (VoIP - Skype, Google Hangouts, etc.), and many others. We have more forms of mediated communication today than we have ever had before in history. Most of us will only experience and use a fraction of the mediated communication technologies that are available for us today.

Key Takeaways

- Intrapersonal communication is communication within yourself.
- Interpersonal communication is the exchange of messages between two people.
- Small group communication consists of three or more individuals.
- Public communication is where you have one speaker and a large audience.
- Mediated communication involves messages sent through a medium to aid the message.

Exercises

- What are some benefits to mediated communication? What are some drawbacks? How does it impact the message?
- Which type of communication would be the most difficult/easiest to study and why?
- As a group, think of some possible research studies for each type of communication. Why would it be important to study?

1.5 Understanding Mindful Communication

LEARNING

OUTCOMES

1. Define the term “mindfulness.”
2. Describe the basic model of mindfulness.
3. Discuss the five facets of mindfulness.
4. Explain the relationship between mindfulness and interpersonal communication.

The words “mindful,” “mindfulness,” and “mindlessness” have received a lot of attention both within academic circles and outside of them. Many people hear the word “mindful” and picture a yogi sitting on

a mountain peak in lotus position meditating while listening to the wind. And for some people, that form of mindfulness is perfectly fine, but it's not necessarily beneficial for the rest of us. Instead, mindfulness has become a tool that can be used to improve all facets of an individual's life. In this section, we're going to explore what mindfulness is and develop an understanding of what we will call in this book "mindful communication."

Defining Mindfulness

Several different definitions have appeared trying to explain what these terms mean. Let's look at just a small handful of definitions that have been put forward for the term "mindfulness."

1. "[M]indfulness as a particular type of social practice that leads the practitioner to an ethically minded awareness, intentionally situated in the here and now."¹⁵
2. "[D]eliberate, open-minded awareness of moment-to-moment perceptible experience that ordinarily requires gradual refinement by means of systematic practice; is characterized by a nondiscursive, nonanalytic investigation of ongoing experience; is fundamentally sustained by such attitudes as kindness, tolerance, patience, and courage; and is markedly different from everyday modes of awareness."¹⁶
3. "[T]he process of drawing novel distinctions... The process of drawing novel distinctions can lead to a number of diverse consequences, including (1) a greater sensitivity to one's environment, (2) more openness to new information, (3) the creation of new categories for structuring perception, and (4) enhanced awareness of multiple perspectives in problem solving."¹⁷
4. "Mindfulness is a flexible state of mind in which we are actively engaged in the present, noticing new things and sensitive to context, with an open, nonjudgmental orientation to experience."¹⁸
5. "[F]ocusing one's attention in a nonjudgmental or accepting way on the experience occurring in the present moment [and] can be contrasted with states of mind in which attention is focused elsewhere, including preoccupation with memories, fantasies, plans, or worries, and behaving automatically without awareness of one's actions."¹⁹
6. "[T]he focus of a person's attention is opened to admit whatever enters experience, while at the same time, a stance of kindly curiosity allows the person to investigate whatever appears, without falling prey to automatic judgment or reactivity."²⁰
7. "Paying attention in a particular way: on purpose, in the present moment, and nonjudgmentally."²¹
8. "Mindfulness is the practice of returning to being centered in this living moment right now and right here, being openly and kindly present to our own immediate mental, emotional, and bodily experiencing, and without judgment."²²
9. "[A]wareness of one's internal states and surroundings. The concept has been applied to various therapeutic interventions—for example, mindfulness-based cognitive behavior therapy, mindfulness-based stress reduction, and mindfulness meditation—to help people avoid destructive or automatic habits and responses by learning to observe their thoughts, emotions, and other present-moment experiences without judging or reacting to them."²³
10. "[A] multifaceted construct that includes paying attention to present-moment experiences, labeling them with words, acting with awareness, avoiding automatic pilot, and bringing an attitude of openness, acceptance, willingness, allowing, nonjudging, kindness, friendliness, and curiosity to all observed experiences."²⁴

What we generally see within these definitions of the term "mindfulness" is a spectrum of ideas ranging from more traditional Eastern perspectives on mindfulness (usually stemming out of Buddhism) to more Western perspectives on mindfulness arising out of the pioneering research conducted by Ellen Langer.²⁵

Towards a Mindfulness Model

Shauna Shapiro and Linda Carlson take the notion of mindfulness a step farther and try to differentiate between mindful awareness and mindful practice:

(a) Mindful awareness, an abiding presence or awareness, a deep knowing that contributes to freedom of the mind (e.g. freedom from reflexive conditioning and delusion) and (b) mindful practice, the systematic practice of intentionally attending in an open, caring, and discerning way, which involves both knowing and shaping the mind. To capture both aspects we define the construct of mindfulness as “the awareness that arises through intentionally attending in an open, caring, and discerning way.”²⁶

The importance of this perspective is that Shapiro and Carlson recognize that mindfulness is a cognitive, behavioral, and affective process. So, let’s look at each of these characteristics.

Mindful Awareness

First, we have the notion of mindful awareness. Most of **mindful awareness** is attending to what’s going on around you at a deeper level. Let’s start by thinking about awareness as a general concept. According to the American Psychological Association’s dictionary, awareness is “perception or knowledge of something.”²⁷ Awareness involves recognizing or understanding an idea or phenomenon. For example, take a second and think about your breathing. Most of the time, we are not aware of our breathing because our body is designed to perform this activity for us unconsciously. We don’t have to remind ourselves to breathe in and out with every breath. If we did, we’d never be able to sleep or do anything else. However, if you take a second and focus on your breathing, you are consciously aware of your breathing. Most breathing exercises, whether for acting, meditation, public speaking, singing, etc., are designed to make you aware of your breath since we are not conscious of our breathing most of the time.

Mindful awareness takes being aware to a different level. Go back to our breathing example. Take a second and focus again on your breathing. Now ask yourself a few questions:

- a. How do you physically feel while breathing? Why?
- b. What are you thinking about while breathing?
- c. What emotions do you experience while breathing?

The goal, then, of mindful awareness is to be consciously aware of your physical presence, cognitive processes, and emotional state while engaged in an activity. More importantly, it’s about not judging these; it’s simply about being aware and noticing.

Mindful Practice

Mindful practice, as described by Shapiro and Carlson, is “the conscious development of skills such as greater ability to direct and sustain our attention, less reactivity, greater discernment and compassion, and enhanced capacity to disidentify from one’s concept of self.”²⁸ To help further explore the concept of mindful practice, Shauna Shapiro, Linda Carlson, John Astin, and Benedict Freedman proposed a three-component model (Figure 1.7): attention, intention, and attitude.²⁹

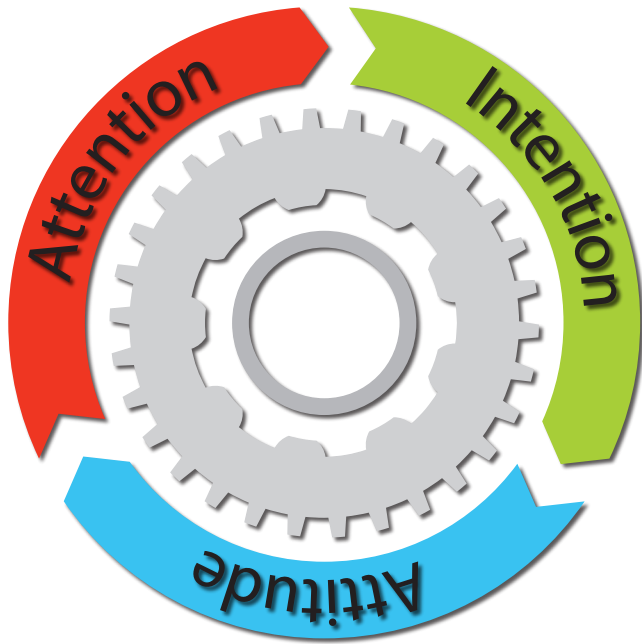

Figure 1.7 Model of Mindfulness

Attention

“*Attention* involves attending fully to the present moment instead of allowing ourselves to become preoccupied with the past or future.”³⁰ Essentially, **attention** is being aware of what’s happening internally and externally moment-to-moment. By internally, we’re talking about what’s going on in your head. What are your thoughts and feelings? By externally, we’re referring to what’s going on in your physical environment. To be mindful, someone must be able to focus on the here and now. Unfortunately, humans aren’t very good at being attentive. Our minds tend to wander about 47% of the time.³¹ Some people say that humans suffer from “monkey mind,” or the tendency of our thoughts to swing from one idea to the next.³² As such, being mindful is partially being aware of when our minds start to shift to other ideas and then refocusing ourselves.

Intention

“**Intention** involves knowing *why* we are doing what we are doing: our ultimate aim, our vision, and our aspiration.”³³ So the second step in mindful practice is knowing why you’re doing something. Let’s say that you’ve decided that you want to start exercising more. If you wanted to engage in a more mindful practice of exercise, the first step would be figuring out why you want to exercise and what your goals are. Do you want to exercise because you know you need to be healthier? Are you exercising because you’re worried about having a heart attack? Are you exercising because you want to get a bikini body before the summer? Again, the goal here is simple: be honest with ourselves about our intentions.

Attitude

“**Attitude**, or *how* we pay attention, enables us to stay open, kind, and curious.”³⁴ Essentially, we can all bring different perspectives when we’re attending to something. For example, “attention can have a cold, critical quality, or an openhearted, curious, and compassionate quality.”³⁵ As you can see, we can approach being mindful from different vantage points, so the “attitude with which you undertake the practice of paying attention and being in the present is crucial.”³⁶ One of the facets of mindfulness is being open and nonjudging, so having that “cold, critical quality” is antithetical to being mindful. Instead, the goal of mindfulness must be one of openness and non-judgment.

So, what types of attitudes should one attempt to develop to be mindful? Daniel Siegel proposed the acronym COAL when thinking about our attitudes: curiosity, openness, acceptance, and love.³⁷

1. C stands for curiosity (inquiring without being judgmental).
2. O stands for openness (having the freedom to experience what is occurring as simply the truth, without judgments).
3. A stands for acceptance (taking as a given the reality of and the need to be precisely where you

are).

4. L stands for love (being kind, compassionate, and empathetic to others and to yourself).³⁸

Jon Kabat-Zinn, on the other hand, recommends seven specific attitudes that are necessary for mindfulness:

1. Nonjudging: observing without categorizing or evaluating.
2. Patience: accepting and tolerating the fact that things happen in their own time.
3. Beginner's-Mind: seeing everything as if for the very first time.
4. Trust: believing in ourselves, our experiences, and our feelings.
5. Non-striving: being in the moment without specific goals.
6. Acceptance: seeing things as they are without judgment.
7. Letting Go: allowing things to be as they are and getting bogged down by things we cannot change.

Neither Siegel's COAL nor Kabat-Zinn's seven attitudes is an exhaustive list of attitudes that can be important to mindfulness. Still, they give you a representative idea of the types of attitudes that can impact mindfulness. Ultimately, "the attitude that we bring to the practice of mindfulness will to a large extent determine its long-term value. This is why consciously cultivating certain attitudes can be very helpful... Keeping particular attitudes in mind is actually part of the training itself."³⁹

Five Facets of Mindfulness

From a social scientific point-of-view, one of the most influential researchers in the field of mindfulness has been Ruth Baer. Baer's most significant contribution to the field has been her Five Facet Mindfulness Questionnaire, which you can take on her [website](#). Dr. Baer's research concluded that there are five different facets of mindfulness: observing, describing, acting with awareness, nonjudging of inner experience, and nonreactivity to inner experience (Figure 1.8).⁴⁰

Observing

The first facet of mindfulness is **observing**, or "noticing or attending to a variety of internal or external phenomena (e.g., bodily sensations, cognitions, emotions, sounds)."⁴¹ When one is engaged in mindfulness, one of the basic goals is to be aware of what is going on inside yourself and in the external environment. Admittedly, staying in the moment and observing can be difficult, because our minds are always trying to shift to new topics and ideas (again that darn monkey brain).

Describing

The second facet of mindfulness is **describing**, or "putting into words observations of inner experiences of perceptions, thoughts, feelings, sensations, and emotions."⁴² The goal of describing is to stay in the moment by being detail focused on what is occurring. We should note that having a strong vocabulary does make describing what is occurring much easier.

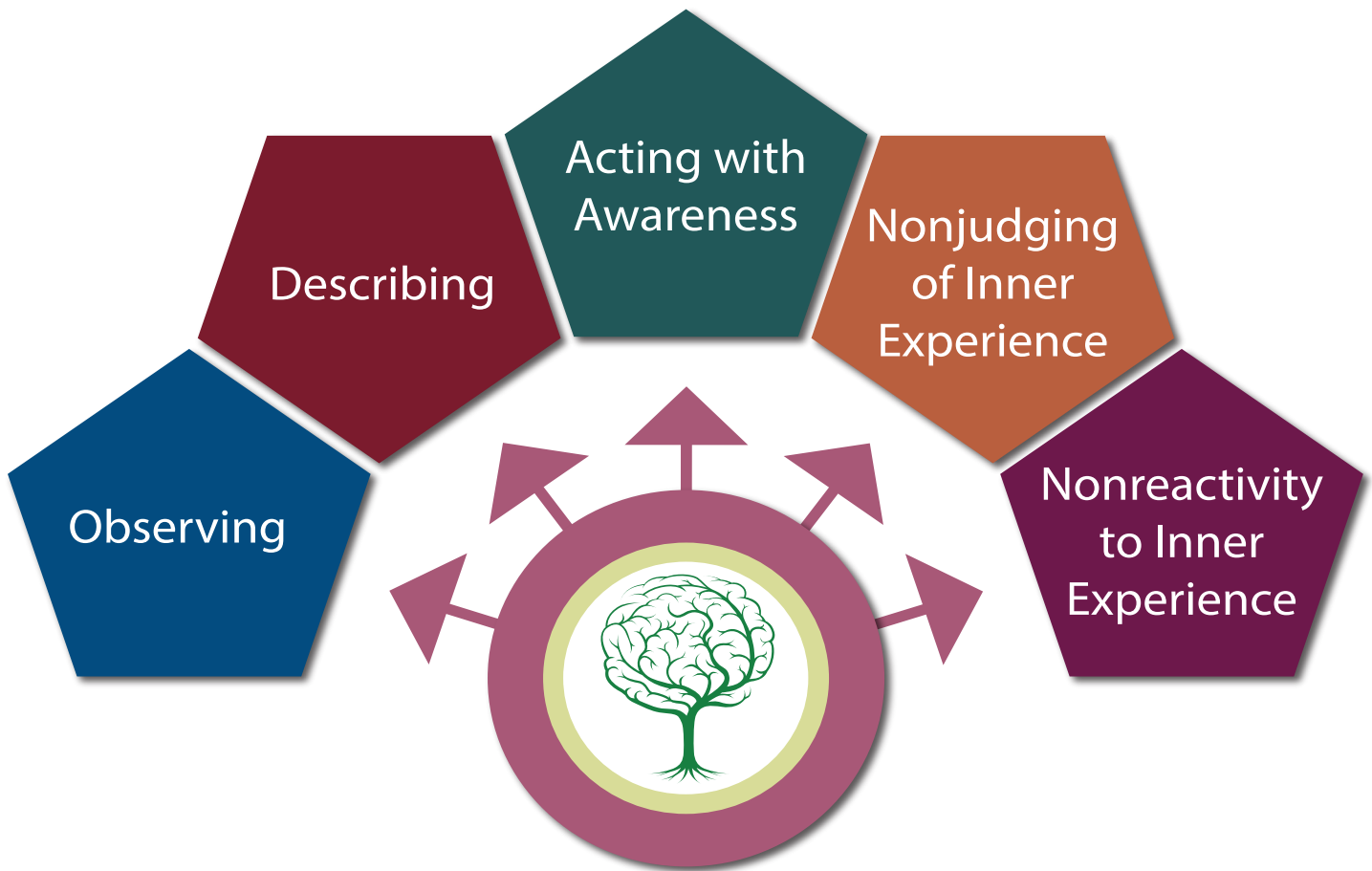

Figure 1.8 Five Facets of Mindfulness

Acting with Awareness

The third facet of mindfulness is **acting with awareness**, or “engaging fully in one’s present activity rather than functioning on automatic pilot.”⁴³ When it comes to acting with awareness, it’s important to focus one’s attention purposefully. In our day-to-day lives, we often engage in behaviors without being consciously aware of what we are doing. For example, have you ever thought about your routine for showering? Most of us have a pretty specific ritual we use in the shower (the steps we engage in as we shower). Still, most of us do this on autopilot without really taking the time to realize how ritualized this behavior is.

Nonjudging of Inner Experience

The fourth facet of mindfulness is the **nonjudging of inner experience**, which involves being consciously aware of one’s thoughts, feelings, and attitudes without judging them. One of the hardest things for people when it comes to mindfulness is not judging themselves or their inner experiences. As humans, we are pretty judgmental and like to evaluate most things as positive or negative, good or bad, etc.... However, one of the goals of mindfulness is to be present and aware. As soon as you start judging your thoughts, feelings, and attitudes, you stop being present and become focused on your evaluations and not your experiences.

Nonreactivity to Inner Experience

The last facet of mindfulness is **nonreactivity to inner experience** “Nonreactivity is about becoming consciously aware of distressing thoughts, emotions, and mental images without automatically responding to them.”⁴⁴ Nonreactivity to inner experience is related to the issue of not judging your inner experience, but the difference is in our reaction. Nonreactivity involves taking a step back and evaluating things from a more logical, dispassionate perspective. Often, we get so bogged down in our thoughts, emotions, and mental images that we end up preventing ourselves from engaging in life.

For example, one common phenomenon that plagues many people is impostor syndrome, or perceived intellectual phoniness.⁴⁵ Some people, who are otherwise very smart and skilled, start to believe that they are frauds and are just minutes away from being found out. Imagine being a brilliant brain surgeon but always afraid someone’s going to figure out that you don’t know what you’re doing. Nonreactivity to our inner experience would involve realizing that we have these thoughts but not letting them influence our actual behaviors. Admittedly, nonreactivity to inner experience is easier described than done for many of us.

MINDFULNESS ACTIVITY



As a simple exercise to get you started in mindfulness, we want to spend 15 minutes coloring. Yep, you heard that right. We want you to color. Now, this may seem a bit of an odd request, but research has shown us that coloring is an excellent activity for increasing mindfulness, reducing anxiety/stress, and increasing your mood.^{46,47,48,49} Coloring also has direct effects on our physiology by reducing our heart rates and blood pressure.⁵⁰ Coloring also helps college students reduce their test anxiety.⁵¹ For this exercise, we’ve created an interpersonal communication, mandala-inspired coloring page. According to Lawrence Shapiro, author of *Mindful Coloring: A Simple and Fun Way to Reduce Stress in Your Life*, here are the basic steps you should take to engage in mindful coloring:

- Set aside 5 to 15 minutes to practice mindful coloring.
- Find a time and place where you will not be interrupted.
- Gather your materials to do your coloring and sit comfortably at a table. You may want to set a timer for 5 to 15 minutes. You should try and continue your mindful practice until the alarm goes off.
- Choose any design you like and begin coloring wherever you like.
- As you color, start paying attention to your breathing. You will probably find that your breathing is becoming slower and deeper, but you don’t have to *try* to relax. In fact, you don’t have to try and do anything. Just pay attention to the design, to your choice of colors, and to the process of coloring.⁵²

After completing this simple exercise, answer the following questions:

1. How did it feel to just focus on coloring?
2. Did you find your mind wandering to other topics while coloring? If so, how did you refocus yourself?
3. How hard would it be to have that same level of concentration when you’re talking with someone?

Interpersonal Communication and Mindfulness

For our purposes within this book, we want to look at issues related to mindful interpersonal communication that spans across these definitions. Although the idea of “mindfulness” and communication is not new,^{53,54} Judee Burgoon, Charles Berger, and Vincent Waldron were three of the first researchers to formulate a way of envisioning mindfulness and interpersonal communication.⁵⁵ As with the trouble of defining mindfulness, perspectives on what mindful communication is differ as well. Let’s look at three fairly distinct definitions:

1. “Communication that is planful, effortfully processed, creative, strategic, flexible, and/or reason-based (as opposed to emotion-based) would seem to qualify as mindful, whereas communication that is reactive, superficially processed, routine, rigid, and emotional would fall toward the mindless end of the continuum.”⁵⁶
2. “Mindful communication including mindful speech and deep listening are important. But we must not overlook the role of compassion, wisdom, and critical thinking in communication. We must be able to empathize with others to see things from their perspective. We should not continue with our narrow prejudices so that we can start meaningful relationships with others. We can then come more easily to agreement and work together.”⁵⁷
3. “Mindful communication includes the practice of mindful presence and encompasses the attributes of a nonjudgmental approach to [our interactions], staying actively present in the moment, and being able to rapidly adapt to change in an interaction.”⁵⁸

As you can see, these perspectives on mindful communication align nicely with the discussion we had in the previous section related to mindfulness. However, there is not a single approach to what is “mindful communication.” Each of these definitions can help us create an idea of what mindful communication is. For our purposes within this text, we plan on taking a broad view of mindful communication that encompasses both perspectives of secular mindfulness and non-secular mindfulness (primarily stemming out of the Buddhist tradition). As such, we define **mindful communication** as the process of interacting with others while engaging in mindful awareness and practice. Although more general than the definitions presented above, we believe that aligning our definition with mindful awareness and practice is beneficial because of Shapiro and Carlson’s existing mindfulness framework.⁵⁹

However, we do want to raise one note about the possibility of mindful communication competence. From a communication perspective, it’s entirely possible to be mindful and not effective in one’s communication. Burgoon, Berger, and Waldron wrote, “without the requisite communication skills to monitor their actions and adapt their messages, without the breadth of repertoire that enables flexible, novel thought processes to translate into creative action, a more mindful state may not lead to more successful communication.”⁶⁰ As such, a marriage must be made between mindfulness and communication skills. This book aims to provide a perspective that enhances both mindfulness and interpersonal communication skills.

Key Takeaways

- The term “mindfulness” encompasses a range of different definitions from the strictly religious (primarily Buddhist in nature) to the strictly secular (primarily

- psychological in nature). Simply, there is not an agreed upon definition.
- Shauna Shapiro and Linda Carlson separate out mindful awareness from mindful practice. Mindful practice involves three specific behaviors: attention (being aware of what's happening internally and externally moment-to-moment.), intention (being aware of why you are doing something), and attitude (being curious, open, and nonjudgmental).
 - Ruth Baer identified the five facets of mindfulness. The five facets of mindfulness are (1) observing (being aware of what is going on inside yourself and in the external environment), (2) describing (being detail-focused on what is occurring while putting it into words), (3) acting with awareness (purposefully focusing one's attention on the activity or interaction in which one is engaged), (4) nonjudging of inner experience (being consciously aware of one's thoughts, feelings, and attitudes without judging them), and (5) nonreactivity to inner experience (taking a step back and evaluating things from a more logical, dispassionate perspective). Mindful communication is the process of interacting with others while engaging in mindful awareness and practice. So much of what we do when we interact with people today centers around our ability to be mindful, in the moment with others. As such, examining how to be more mindful in our communication with others is essential to competent communication.

Exercises

- If you haven't already tried mindful coloring, please take this opportunity to try it out. Give yourself 10 to 15 minutes in a quiet space to just sit and focus on the coloring. Try not to let yourself get disturbed by other things in your environment. Just focus on being present with your colors and the coloring sheet.
- Want to try something a bit deeper in mindfulness? Consider starting simple meditation. Meditating is an important facet of mindfulness, and although most religious traditions have some form of meditation practice built into the religion, it is not specifically religious in nature. Even atheists can meditate. Try a simple meditation like:

Seated Breath Meditation: This technique can help you:

- Enhance mental clarity
- Be fully present in the moment
- Understand your inner emotional state
- Feel grounded

Find a quiet place. Light a candle if you wish. Sit tall in your chair, feet on the floor, or sit comfortably on the floor. Align your spine, shoulders over hips, as if suspended from above. Hands can be in your lap or on your thighs, palms up, or press palms together at heart. Feel your posture as both rooted and energetic. Eyes can be closed or softly focused. Mouth is

closed, tongue relaxed. Be sure you can breathe comfortably.

Center your awareness on your nostrils, where the air enters and leaves your body. Notice your breath. Begin counting your breaths, returning to one every time a thought intrudes. When thoughts come in, notice them, then let them go. Bring yourself back to your physical body, to the breath coming in and out.

Source: Thousand Waves Martial Arts & Self Defense Center (thousandwaves.org)

- Want to try some longer meditation practices? [The Free Mindfulness Project](#) has links to a number of mindfulness audio files.

Chapter Wrap-Up

In this chapter, we explored why it's important to study human communication, the basic principles of human communication, the nature of communication competence, the types of human communication, and mindful communication. We hope this chapter makes you interested in staying with us throughout the rest of the book as we explore interpersonal communication.

End of Chapter

KEY TERMS

- Acting with Awareness
- Appropriate Communication
- Attention
- Attitude
- Cognitive Complexity
- Communication
- Communication Competence
- Connotative Definitions
- Denotative Definitions
- Describing
- Effective Communication
- Group
- Intention
- Interpersonal Communication
- Intrapersonal Communication
- Mediated Communication
- Mindful Awareness
- Mindful Communication
- Mindful Practice
- Nonjudging of Inner Experience
- Nonreactivity to Inner Experience
- Observing
- Public Communication
- Self-Monitoring
- Symbol

REAL WORLD CASE STUDY

Noam is a freshman in college and doesn't understand why he needs to take a communication studies course. He doesn't see the importance or application of this course. He wants to be an engineer. His math and engineering classes are more exciting than a communications course. He has been talking his whole life and is very popular.

Can you convince him why communication is important for Noam?

END OF CHAPTER QUIZ

- Which of the following are reasons for studying communication?
 - to increase our effectiveness
 - gives us a new perspective
 - because we spend so much time doing it
 - a and b
 - all of the above
- My mother told me that I would succeed at anything I put my mind to and that I could achieve anything. Which type of need is this example?
 - physical
 - practical
 - identity
 - social
 - affectionate
- Communication is all the following except:
 - purposeful
 - contains a relationship dimension
 - contains a content dimension
 - culturally determined
 - assumed
- An individual at a concert flashes a friend the "peace sign" using her index and middle finger to form the letter "v." This is an example of what?
 - a sign
 - a word
 - mediated communication
 - an emoji
 - a symbol
- Which type of communication involves the exchange of messages between two people?
 - intrapersonal
 - interpersonal
 - small group
 - public
 - mass



Mindfulness:

Attention,

Intention,

and

Attitude

References

- 1 Bochner, A. P. (1989). Interpersonal communication. In E. Bamouw, G. Gerbner, W. Schramm, T. L. Worth, & L. Gross (Eds.), *International encyclopedia of communications* (pp. 336-340). New York: Oxford University Press; pg. 336.
- 2 Knapp, M. L., & Daly, J. A. (2011). Background and current trends in the study of interpersonal communication. In M. L. Knapp & J. Daly (Eds.), *The SAGE handbook of interpersonal communication* (4th ed., pp. 3-22). Thousand Oaks, CA: SAGE.
- 3 Morreale, S. P., & Pearson, J. C. (2008). Why communication education is important: The centrality of the discipline in the 21st. century. *Communication Education*, 57(2), 224-240. <https://doi.org/10.1080/03634520701861713>
- 4 Chen, G. M. (2011). Tweet this: a uses and gratifications perspective on how active twitter use gratifies a need to connect with others. *Computers in Human Behavior*, 27, 755-762. <https://doi.org/10.1016/j.chb.2010.10.023>
- 5 Francis, L. E. (2003). Feeling good, feeling well: Identity, emotion, and health. In T.J. Owens & P. J. Burke (Eds.), *Advances in identity theory and research* (pp. 123-134). Kluwer Academic /Plenum Press.
- 6 Adler, R. B., Rosenfeld, L. R., & Proctor R. F., 11. (2007). *Interplay: The process of interpersonal Communication* (10th ed.). Oxford.
- 7 Koesten, J. (2004). Family communication patterns, sex of subject, and communication competence. *Communication Monographs*, 71(2), 226-244. <https://doi.org/10.1080/0363775052000343417>
- 8 Kinnick, K. N. & Parton, S. R. (2005). Workplace communication: what the apprentice teaches about communication skills. *Business Communication Quarterly*, 68(4), 429-456. <https://doi.org/10.1177/1080569905282099>
- 9 Canary, D. J., Stafford, L., & Semic, B. A. (2002). A panel study of the associations between maintenance strategies and relational characteristics. *Journal of Marriage and Family*, 64(2), 395-406. <https://doi.org/10.1111/j.1741-3737.2002.00395.x>
- 10 Stafford, L., & Canary, D. J. (1991). Maintenance strategies and romantic relationship type, gender, and relational characteristics. *Journal of Social and Personal Relationships*, 8(2), 217-242. <https://doi.org/10.1177/0265407591082004>
- 11 Berlo, D. K. (1960). *The process of communication*. Holt, Rinehart, & Winston.
- 12 Wrench, J. S., McCroskey, J. C., & Richmond, V. P. (2008). *Human communication in everyday life: Explanations and applications*. Allyn & Bacon, pg. 421.
- 13 Spitzberg, B. H. (2000). What is good communication? *Journal of the Association for Communication Administration*, 29, 103-119.
- 14 Riccillo, S. C. (1994). Phylogenesis: Understanding the biological origins of intrapersonal communication. In D. R. Vocate (Ed.), *Intrapersonal communication: Different voices, different minds* (pp. 33-56). Lawrence Erlbaum; pg. 35.
- 15 Nilsson, H., & Kazemi, A. (2016). Reconciling and thematizing definitions of mindfulness: The big five of mindfulness. *Review of General Psychology*, 20(2), 183-193. <https://doi.org/10.1037/gpr0000074>, pg. 190.
- 16 Grossman, P. (2011). Defining mindfulness by how poorly I think I pay attention during everyday awareness and other intractable problems for psychology's (re)invention of mindfulness: Comment on Brown et al. (2011). *Psychological Assessment*, 23(4), 1034-1040. <https://doi.org/10.1037/a0022713>; pg. 1035.
- 17 Langer, E. J., & Moldoveanu, M. (2000). The construct of mindfulness. *The Journal of Social Issues*, 56(1), 1-9. <https://doi.org/10.1111/0022-4537.00148>; pgs. 1-2.
- 18 Langer, E. J. (1989). *Mindfulness*. Da Capo; pg. 220.
- 19 Baer, R. A., Smith, G. T., & Allen, K. B. (2004). Assessment of mindfulness by self-report: The Kentucky inventory of mindfulness skills. *Assessment*, 11(3), 191-206. <http://dx.doi.org/10.1177/1073191104268029>; pg. 191.
- 20 Segal, Z. V., Williams, J. M. G., & Teasdale, J. D. (2002). *Mindfulness-based cognitive therapy for depres-*

sion: *A new approach to preventing relapse*. Guilford Press; pgs. 322–323.

- 21 Kabat-Zinn, J. (2005). *Wherever you go there you are: Mindfulness meditation in everyday life*. Hyperion; pg. 4.
- 22 Gordon, R. D. (2018). *Tuning-in: The art of mindful communicating*. iUniverse; pg. 24.
- 23 American Psychological Association. (n.d.). Mindfulness. In *APA dictionary of psychology*. Retrieved February 8, 2020, from <https://dictionary.apa.org/mindfulness>
- 24 Sauer, S., & Baer, R. A. (2010). Mindfulness and decentering as mechanisms of change in mindfulness- and acceptance-based interventions. In R. A. Baer (Ed.), *Assessing mindfulness & acceptance process in clients: Illuminating the theory & practice of change* (pp. 25-50). Context Press; pg. 28.
- 25 Langer, E. J. (1989). *Mindfulness*. Da Capo.
- 26 Shapiro, S. L., & Carlson, L. E. (2017). *The art and science of mindfulness: Integrating mindfulness into psychology and the helping professions* (2nd ed.). American Psychological Association, pg. 2.
- 27 American Psychological Association. (n.d.). Awareness. In *APA dictionary of psychology*. Retrieved February 8, 2020, from <https://dictionary.apa.org/awareness>
- 28 Shapiro, S. L., & Carlson, L. E. (2017). *The art and science of mindfulness: Integrating mindfulness into psychology and the helping professions* (2nd ed.). American Psychological Association.
- 29 Shapiro, S. L., Carlson, L. E., Astin, J. A., & Freedman, B. (2006). Mechanisms of mindfulness. *Journal of Clinical Psychology*, 62(3), 373–386. <https://doi.org/10.1002/jclp.20237>
- 30 Shapiro, S., Thakur, S., & Sousa, S. (2014). Mindfulness for health care professionals and therapists in training. In R. A. Baer (Ed.), *Mindfulness-based treatment approaches clinician's guide to evidence base and applications* (2nd ed., pp. 319-345). Academic Press; pg. 320.
- 31 Killingsworth, M. A., & Gilbert, D. T. (2010). A wandering mind is an unhappy mind. *Science*, 330(6006), 932. <https://doi.org/10.1126/science.1192439>
- 32 Shapiro, S., Thakur, S., & Sousa, S. (2014). Mindfulness for health care professionals and therapists in training. In R. A. Baer (Ed.), *Mindfulness-based treatment approaches clinician's guide to evidence base and applications* (2nd ed., pp. 319-345). Academic Press.
- 33 Ibid.; pg. 320.
- 34 Ibid. pg. 320.
- 35 Ibid. pg. 321.
- 36 Kabat-Zinn, J. (1990). *Full catastrophe living: Using the wisdom of your body and mind to face stress, pain and illness*. Delacorte; pg. 19.
- 37 Siegel, D. J. (2007). Mindfulness training and neural integration: Differentiation of distinct streams of awareness and the cultivation of well-being. *Social Cognitive and Affective Neuroscience*, 2(4), 259–263. <https://dx.doi.org/10.1093/scan/nsm034>
- 38 Fogel, S. J. (n.d.). Mindful awareness and COAL. *Steven J. Fogel Blog*. <http://stevenjayfogel.com/mindful-awareness-and-coal/>
- 39 Kabat-Zinn, J. (1990). *Full catastrophe living: Using the wisdom of your body and mind to face stress, pain and illness*. Delacorte; pgs. 20-21.
- 40 Baer, R. A., Smith, G. T., Hopkins, J., Krietemeyer, J., & Toney, L. (2006). Using self-report assessment methods to explore facets of mindfulness. *Assessment*, 13(1), 27-45. <https://doi.org/10.1177/1073191105283504>
- 41 Sauer, S., & Baer, R. A. (2010). Mindfulness and decentering as mechanisms of change in mindfulness- and acceptance-based interventions. In R. A. Baer (Ed.), *Assessing mindfulness & acceptance process in clients: Illuminating the theory & practice of change* (pp. 25-50). Context Press; pg. 31.
- 42 Sørensen, L., Osnes, B., Visted, E., Svendsen, J. L., Adolfsdottir, S., Binder, P. E., & Schanche, E. (2018, November). Dispositional mindfulness and attentional control: The specific association between the mindfulness facets of non-judgment and describing with flexibility of early operating orienting in conflict detection. *Frontiers in Psychology*, 29, 1-9. <https://doi.org/10.3389/fpsyg.2018.02359>; pg. 2.
- 43 Sauer, S., & Baer, R. A. (2010). Mindfulness and decentering as mechanisms of change in mindfulness- and acceptance-based interventions. In R. A. Baer (Ed.), *Assessing mindfulness & acceptance process in clients:*

Illuminating the theory & practice of change (pp. 25-50). Context Press; pg. 31.

44 Galla, B. M., Tsukayama, E., Park, D., Yu, A., & Duckworth, A. L. (2020). The mindful adolescent: Developmental changes in nonreactivity to inner experiences and its association with emotional well-being. *Developmental Psychology*, 56(2), 350–363. <http://dx.doi.org/10.1037/dev0000877>; pg. 351.

45 Clance, P. R., & Imes, S. A. (1978). The imposter phenomenon in high achieving women: Dynamics and therapeutic intervention. *Psychotherapy: Theory, Research & Practice*, 15(3), 241–247. <https://doi.org/10.1037/h0086006>

46 Flett, J. A. M., Lie, C., Riordan, B. C., Thompson, L. M., Conner, T. S., & Hayne, H. (2017). Sharpen your pencils: Preliminary evidence that adult coloring reduces depressive symptoms and anxiety. *Creativity Research Journal*, 29(4), 409-416. <https://doi.org/10.1080/10400419.2017.1376505>

47 van der Venet, R., & Serice, S. (2012). Can coloring mandalas reduce anxiety? A replication study. *Art Therapy*, 29(2), 87-92. <https://doi.org/10.1080/07421656.2012.680047>

48 Mantzios, M., & Giannou, K. (2018). When did coloring books become mindful? Exploring the effectiveness of a novel method of mindfulness-guided instructions for coloring books to increase mindfulness and decrease anxiety. *Frontiers in Psychology*, 30. <https://doi.org/10.3389/fpsyg.2018.00056>

49 Ashdown, B. K., Bodenlos, J. S., Arroyo, K., Patterson, M., Parkins, E., & Burstein, S. (2018). How does coloring influence mood, stress, and mindfulness? *Journal of Integrated Social Sciences*, 8(1), 1-21. <https://tinyurl.com/sp6k6qv>

50 DeLue, C. (1999). Physiological effects of creating mandalas. In C. Malchiodi (Ed.), *Medical art therapy with children* (pp. 33-49). Jessica Kingsley.

51 Gençdoğan, B., Çetinkaya, S. K., Gümüş, E. (2018). Effects of coloring mandalas on test anxiety. *Inonu University Journal of the Faculty of Education*, 19(1), 221-229. <https://doi.org/10.17679/inuefd.415982>

52 Shapiro, L. E. (2016). Mindful coloring: A simple & fun way to reduce stress in your life. <https://tinyurl.com/y3uqocrf>; pg. 2.

53 Benoit, P. J., & Benoit, W. L. (1986). Consciousness: The mindlessness/mindfulness and verbal report controversies. *The Western Journal of Speech Communication*, 50(1), 41-63. <https://doi.org/10.1080/10570318609374212>

54 Motley, M. T. (1992). Mindfulness in solving communicators' dilemmas. *Communication Monographs*, 59(3), 306-314. <https://doi.org/10.1080/03637759209376272>

55 Burgoon, J. K., Berger, C. R., & Waldron, V. R. (2000). Mindfulness and interpersonal communication. *Journal of Social Issues*, 56(1), 105-127.

56 Ibid.; pg. 112.

57 Sivaraksa, S. (2018). Mindful Communication for Sustainable Development. In K. Seneviratne (Ed.), *Mindful communication for sustainable development: Perspectives from Asia* (pp. 29-33). Sage; pg. 31.

58 Prince-Paul, M., & Kelly, C. (2017). Mindful communication: Being present. *Seminars in Oncology Nursing*, 3(5), 475-482; pg. 476.

59 Shapiro, S. L., & Carlson, L. E. (2017). *The art and science of mindfulness: Integrating mindfulness into psychology and the helping professions* (2nd ed.). American Psychological Association.

60 Burgoon, J. K., Berger, C. R., & Waldron, V. R. (2000). Mindfulness and interpersonal communication. *Journal of Social Issues*, 56(1), 105-127; pg. 121.

END OF CHAPTER QUIZ

ANSWER KEY

1) E 2) C 3) E 4) E 5) B

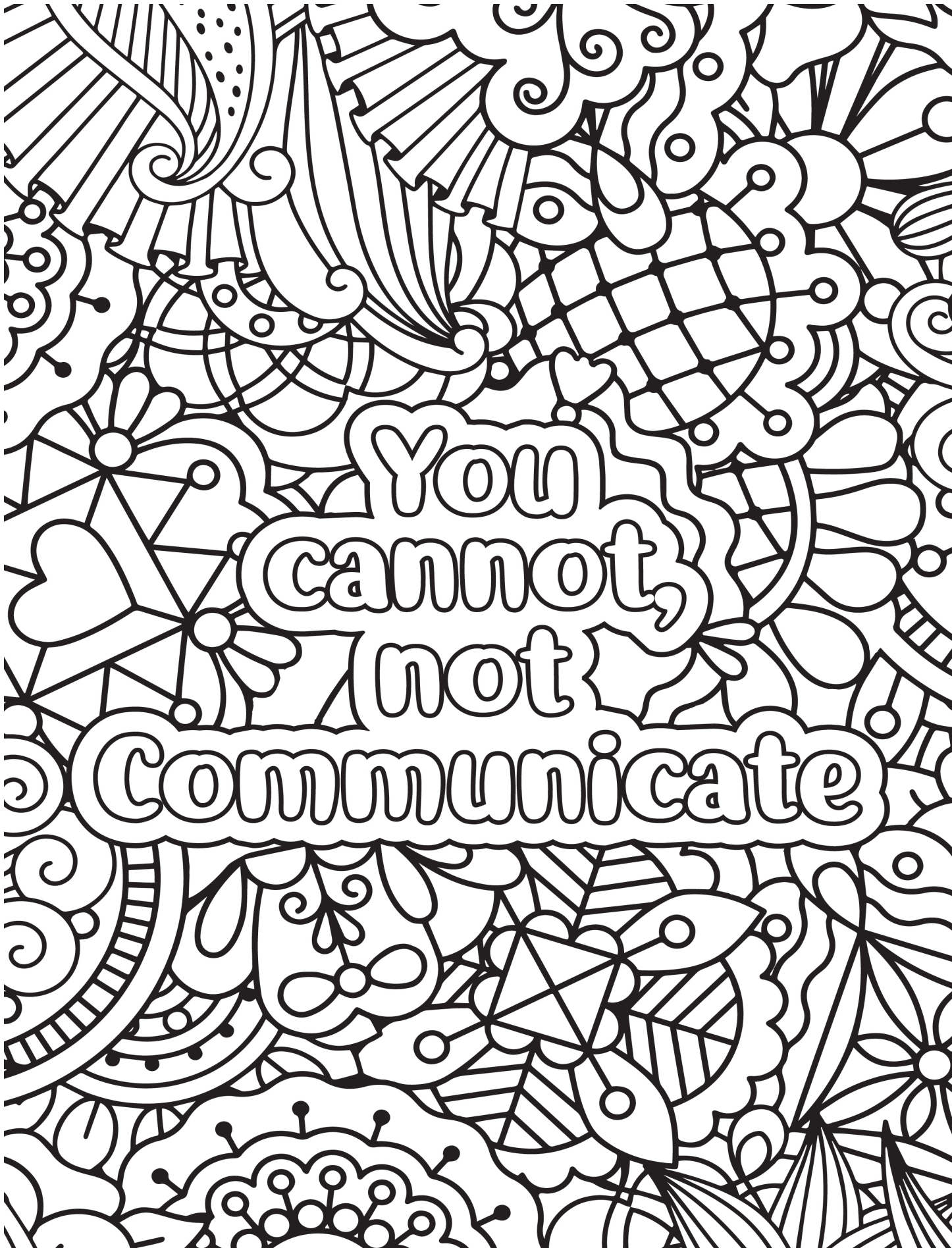



Image by [Sasint](#) from [Pixabay](#)

Chapter 2

Overview of Interpersonal Communication

Cardi and Tilly have been friends since they were both in kindergarten. They are both applying to the same college, hoping to be roommates. However, Cardi gets accepted, but Tilly does not. Cardi is crushed because she wanted to share her college experience with her best friend. Tilly tells Cardi to go without her and she will try again next year after attending the local junior college for a semester. Cardi is not as excited to go to college anymore, because she is worried about Tilly. Cardi talks about different options with her parents, her other friends, and posts about it on social media. This idea of sharing our experiences, whether it be positive, or negative is interpersonal communication. When we offer information to other people and they offer information towards us, it is defined as interpersonal communication.

Interpersonal Communication can be informal (the checkout line) or formal (lecture classroom). Often, interpersonal communication occurs in face-to-face contexts. It is usually unplanned, spontaneous, and ungrammatical. Think about the conversations that you have with your friends and family. These are mainly interpersonal in nature. It is essential to learn about interpersonal communication because this is the type of communication that you will be doing for most of your life. At most colleges, public speaking

is a required course. Yet, most people will not engage in making a public speech for the majority of their life, but they will communicate with one other person daily, which is interpersonal communication. Interpersonal communication can help us achieve our personal and professional goals. In this chapter, you will learn the concepts associated with interpersonal communication and how certain variables can help you achieve your goals.

In this chapter, you will learn about ways to make communication more effective. You will learn about communication models that might influence how a message is sent and/or received. You will also learn about characteristics that influence the message and can cause others not to accept or understand the message that you were trying to send.

2.1 Purposes of Interpersonal Communication

LEARNING OUTCOMES

1. Explain Maslow's Hierarchy of Needs and its relationship to communication.
2. Describe the relationship between self, others, and communication.
3. Understand building and maintaining relationships.

Meeting Personal Needs

Communication fulfills our physical, personal, and social needs. Research has shown a powerful link between happiness and communication.¹ In this particular study that included over 200 college students, they found that the ones who reported the highest levels of happiness also had a very active social life. They noted there were no differences between the happiest people and other similar peers in terms of how much they exercised, participated in religion, or engaged in other activities. The results from the study noted that having a social life can help people connect with others. We can connect with others through effective communication. Overall, communication is essential to our emotional wellbeing and perceptions about life.

Everyone has dreams that they want to achieve. What would happen if you never told anyone about your dreams? Would it really be possible to achieve your dreams without communication? To make your dreams a reality, you will have to interact with several people along the way who can help you fulfill your dreams and personal needs. The most famous people in history, who were actors, musicians, politicians, and business leaders, all started with a vision and were able to articulate those ideas to someone else who could help them launch their careers.

There are practical needs for communication. In every profession, excellent communication skills are a necessity. Doctors, nurses, and other health professionals need to be able to listen to their patients to understand their concerns and medical issues. In turn, these health professionals have to be able to communicate the right type of treatment and procedures so that their patients will feel confident that it is the best type of outcome, and they will comply with these medical orders.

Research has shown that couples who engage in effective communication report more happiness than couples who do not.² Communication is not an easy skill for everyone. As you read further, you will see that there are a lot of considerations and variables that can affect how a message is relayed and received.

As the arrow in Figure 2.1 indicates, Maslow believed that human needs emerge in order starting from the bottom of the pyramid. At the basic level, humans must have *physiological* needs met, such as breathing, food, water, sex, homeostasis, sleep, and excretion. Once the physiological needs have been met, humans can attempt to meet *safety* needs, which include the safety of the body, family, resources,

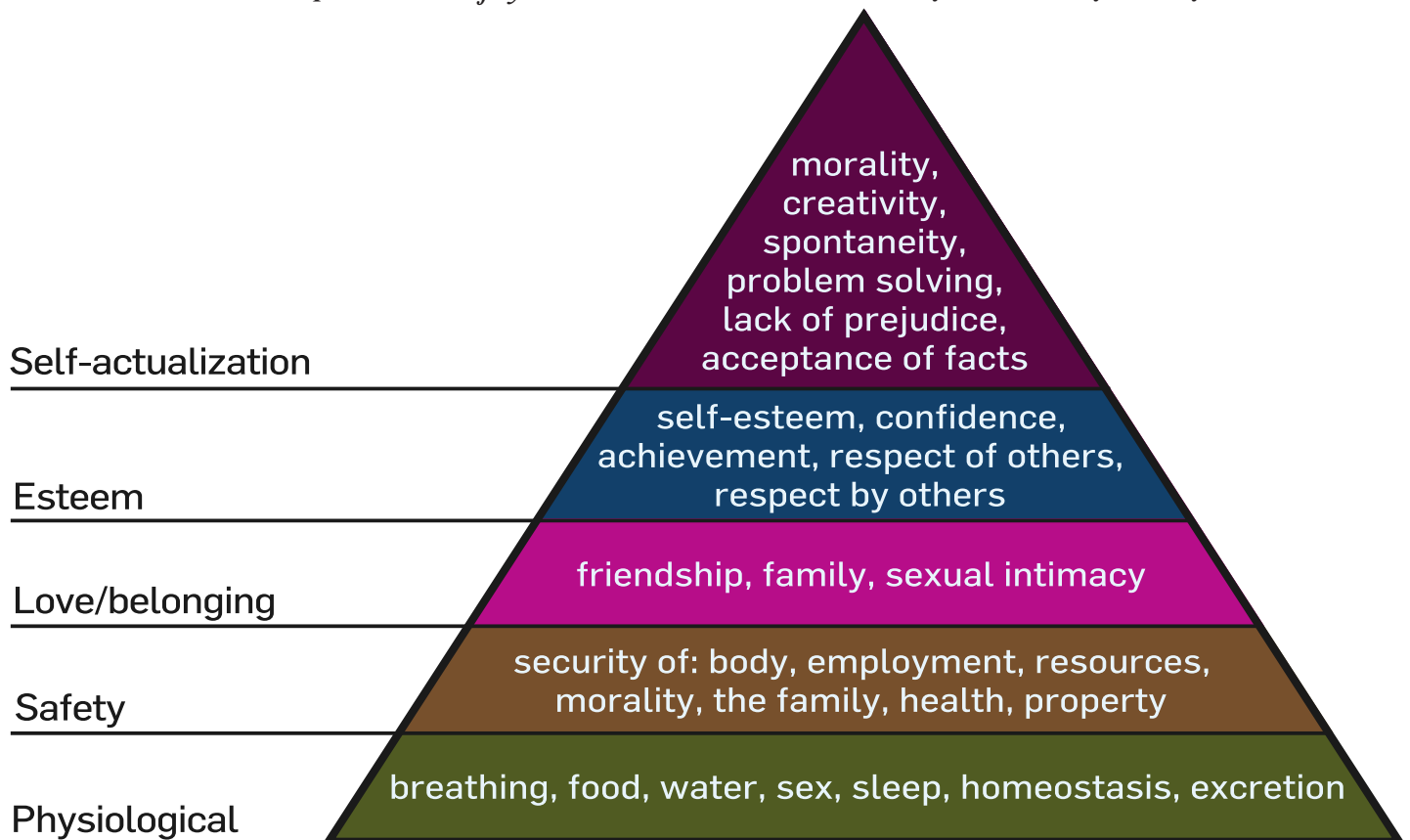

Figure 2.1 Maslow's Hierarchy of Needs

morality, health, and employment. A higher-order need that must be met is *love and belonging*, which encompasses friendship, sexual intimacy, and family. Another higher-order need that must be met before self-actualization is *esteem*, which includes self-esteem, confidence, achievement, respect of others, and respect by others. Maslow argued that all of the lower needs were necessary to help us achieve psychological health and eventually self-actualization.³ Self-actualization leads to creativity, morality, spontaneity, problem-solving, lack of prejudice, and acceptance of facts.

Communicating and Meeting Personal Needs

As you will learn reading this chapter, it is important to understand people and know that people often communicate to satisfy their needs, but each person's need level is different. To survive, physiological and safety needs must be met. Through communication, humans can work together to grow food, produce food, build shelter, create safe environments, and engage in protective behaviors. Once physiological and safety needs have been met, communication can then shift to love and belonging. Instead of focusing on living to see the next day, humans can focus on building relationships by discussing perhaps the value of a friendship or the desire for sexual intimacy. After creating a sense of love and belonging, humans can move forward to working on "esteem." Communication may involve sharing praise, working toward goals, and discussion of strengths, which may lead to positive self-esteem. When esteem has been addressed and met, humans can achieve self-actualization. Communication will be about

making life better, sharing innovative ideas, contributions to society, compassion and understanding, and providing insight to others. Imagine trying to communicate creatively about a novel or express compassion for others while starving and feeling unprotected. The problem of starving must be resolved before communication can shift to areas addressed within self-actualization.

Critics of Maslow's theory argue that the hierarchy may not be absolute because it could be possible to achieve self-actualization without meeting the lower needs.⁴ For example, a parent/guardian might put before the needs of the child first if food is scarce. In this case, the need for food has not been fully met, and yet the parent/guardian is able to engage in self-actualized behavior. Other critics point out that Maslow's hierarchy is rather Western-centric and focused on more individualistic cultures (focus is on the individual needs and desires) and not applicable to cultures that are collectivistic (focus is on the family, group, or culture's needs and desires).⁵

It is important to understand needs because other people may have different needs. This can influence how a message is received. For instance, Shaun and Dee have been dating for some time. Dee wants to talk about wedding plans and the possibility of having children. However, Shaun is struggling to make ends meet. He is focused on his paycheck and where he will get money to cover his rent and what his next meal will be due to his tight income. It is very hard for Shaun to talk about their future together and future plans, when he is so focused on his basic physiological needs for food and water. Dee is on a different level, love and belonging, because she doesn't have to worry about finances. Communicate can be difficult when two people have very drastic needs that are not being met. This can be frustrating to both Dee and Shaun. Dee feels like Shaun doesn't love her because he refuses to talk about their future together. Shaun is upset with Dee, because she doesn't seem to understand how hard it is for him to deal with such a tight budget. If we are not able to understand the other person's needs, then we won't be able to have meaningful conversations.

Learning About Self and Others

Communication is powerful, and sometimes words can affect us in ways that we might not imagine. Think back to a time when someone said something hurtful or insightful to you. How did it make you feel? Did you feel empowered to prove that person wrong or right? Even in a classroom, peers can say things that might make you reconsider how to feel about yourself.

Classmates provide a great deal of feedback to each other. They may comment on how well one particular student does, and this contributes to the student's self-concept. The student might think, "People think I am a good student, so I must be." When we interact with others, how they perceive and relate to us impacts our overall self-concept. According to Reñe M. Dailey,⁶ adolescents' self-concepts were impacted by daily conversations when acceptance and challenges were present.

In high school, peers can be more influential than family members. Some peers can say very hurtful things and make you think poorly of yourself. And then, some peers believe in you and make you feel supported in your ideas. These interactions shape us in the person we are today.

On a job interview, if someone asks you to tell them about yourself, how would you describe yourself? The words that you use are related to your self-concept. Self-concept refers to the perceptions that you view about yourself. These perceptions are relatively stable. These might include your preferences, talents, emotional states, pet peeves, and beliefs.

Self-esteem is a part of self-concept. Self-esteem includes judgments of self-worth. A person can vary on high to low evaluations of self-esteem. People with high self-esteem will feel positive about themselves and others. They will mainly focus on their successes and believe that others' comments are helpful.

Discovering Self-Concept - Who are you?

As a means to determine your self-concept, address the following questions, and ask others to answer the question about you.

Questions:

- Where did you grow up?
- What did you enjoy doing as a child?
- What qualities did others recognize in you as you grew up? (ex. “I know I can rely on you.” Or “You are good at making people laugh.”)
- When you are with a group of people, what is your role in the group? (Ex. Listening, coordinating meeting times and location, initiating getting together).

Why do you think you communicate the way that you do? Is it based on some of the answers to these self-reflexive questions? Sometimes people behave and interact with others because of their past experiences, their background, and/or their observations with others.

On the other hand, people with low self-esteem will view things negatively and may focus more on their failures. They are more likely to take other people’s comments as criticism or hostility. A recent study found that people with low self-esteem prefer to communicate indirectly, such as an email or text, rather than face-to-face compared to people with high self-esteem.⁷

Building and Maintaining Relationships

Research indicates that your self-concept doesn’t happen when you are born.⁸ Rather, it happens over time. When you are very young, you are still learning about your body. Some children’s songs talk about your head, shoulders, and toes. As you develop into an adult, you learn more about yourself with others. It is through this communication with others that we not only learn about our self, but we can build and maintain relationships. To start a relationship with someone else, we might ask them very generic questions, such as their favorite color or favorite movie. Once we have established a connection, we might invite them to coffee or lunch. As we spend time with others, then we learn more about them by talking with them, and then we discover our likes and dislikes with someone. It is through this sharing of information with others that we learn more about them. We can build intimacy and a deeper connection with others when they tell us more about their experiences and their perspectives.

Think about all the relationships that you have developed over time. Now think about how these people either shaped your self-concept or perceptions regarding your self-esteem. For instance, you may have had a coach or teacher that impacted the way that you learn about a certain topic. You may have had an inspirational teacher that helped you find your career path or you might have had a coach that constantly embarrassed you in front of your teammates by yelling at you. These two very different experiences can impact how you feel about yourself.

We are constantly receiving messages from people throughout our life. On social media, there will

be people who like our posts, but there might be some who disagree or not like what we post. These experiences can help us understand what we value and what things we may choose to ignore.

From an early age, we might compare ourselves to others. This is called social comparison. For instance, in grade school, your teacher might have asked everyone to line up against the wall to see who is the tallest and who is the shortest. Instinctively, we already compare ourselves to others. When there is an exam, students want to know how other people performed on the exam to see if they are different or similar. By comparing ourselves to others, we might be able to discern if we are better or worse than others, which can, in turn, influence our self-esteem.

We will build and maintain relationships with others who have similar self-concepts to us, or we perceive them to have a similar self-concept about ourselves. Your closest friends are usually people that are similar to you in some way. These relationships most likely occurred because you were willing to disclose information about yourself to see if you were similar or compatible with the other person.

Uncertainty Reduction Theory

As humans habitually form relationships, theorists Charles Berger and Richard Calabrese⁹ sought to understand how humans begin relationships. Their research focused on the initiation of relationships, and it was observed that humans, in first meetings, attempt to reduce uncertainty. Thus, the **Uncertainty Reduction theory** emerged. This theory addressed cognitive uncertainty (uncertainty associated with the beliefs and attitudes of another) and behavioral uncertainty (uncertainty regarding how another person might behave). Three strategies are used to reduce uncertainty, including passive, active, and interactive strategies. Passive strategies avoid disrupting the other individual and can be accomplished through observation. Active strategies involve asking a friend for information or observing social networking such as Facebook, Twitter, and Instagram. Finally, interactive strategies involve direct contact with the other individual.

Charles Berger and Richard Calabrese (1975) believed that when we meet new people, we are fraught with uncertainty about the new relationship and will seek to reduce this uncertainty and its resulting anxiety.¹⁰ They found that the best and most common way of reducing this uncertainty is through self-disclosure. As such, self-disclosure needs to be reciprocal to successfully reduce uncertainty. Upon new introductions, we tend to consider three things: (1) The person's ability to reward or punish us, (2) the degree to which they meet or violate our social expectations, and (3) whether we expect to reencounter them. Most of these considerations are made instantly and often through expectancy biases. Research revealed that we tend to make snap decisions about people upon meeting them based on previously held beliefs and experiences and that these decisions are extremely difficult to overcome or change.¹¹ When we meet other people, there is a ton of information for us to go through very quickly, so just as in other situations, we draw on our previous understandings and experiences to make assumptions about this new person. The process of self-disclosure allows us to gain more data to create a more accurate understanding of other individuals, which gives us better insight into their future actions and reduces our uncertainty of them.

These ideas can be seen very clearly in the digital age as they relate to Chang, Fang, and Huang's (2015) research on consumer reviews online and their effect on potential purchasers.¹² They found that similarities in a reviewer's diction to the shoppers' language, and the confirmation of the shoppers' prior beliefs, created more credibility. We are more comfortable with things and people that are like us, and that we understand and can predict. How does this translate to more personal forms of computer-mediated communication (CMC) such as email?

In another study, researchers sought to find out what factors influence our understanding of such messages.¹³ They found that the individual personality of the receiver was the biggest factor in the way the messages were interpreted. Again we see that we as humans interpret data in as much as we are familiar with that data. We will consistently make assumptions based on what we would do or have experienced previously. The lack of nonverbal information in CMC adds to this. We have very little more than text to use in the formation of our opinions and seek to eliminate the uncertainty.

We need to go back then to the solution that Berger and Calabrese found for the reduction of uncertainty, self-disclosure. Many new relationships today, particularly in the dating world, begin online. To be successful in these initial encounters, the key would seem to be to engage in as much self-disclosure as possible on the front end to help others reduce anxiety based on uncertainty. More research in this area would support that an increase in self-disclosure results in an increase in positive reactions from similar users in a social network. The implied problem of all of this is that there is little to no way to verify the information disclosed by users. So a new kind of uncertainty reduction theory seems necessary. How can we alter our previous notions of human behavior to reflect a culture in which deception is presumably so much easier? Is the answer to live in a world of uncertainty and its resulting anxiety? To what degree must we assume the best of others and engage in potentially risky relationships to maintain a functional society? Who can we

Key Takeaways

- Maslow's Hierarchy of Needs impacts the content of communication as well as the purpose.
- The feedback we receive from others provides insight into who we are as individuals.
- A major theory in building relationships is Uncertainty Reduction Theory, which explains how we put ourselves at ease with others.

Exercises

- Write down a list of questions you asked when you first met your college roommate or a new friend? Review these questions and write down why these questions are useful to you.
- Recall a situation in which you were recently carrying on a conversation with another person. Write down the details of the conversation. Now, relate the parts of the conversation to Maslow's Hierarchy of Needs.

2.2 Elements of Interpersonal Communication

LEARNING OUTCOMES

1. Understand that communication is a process.
2. Differentiate among the components of communication processes and communication models.
3. Describe the differences between the sender and receiver of a message.

You may think that communication is easy. However, at moments in your life, communication might be hard and difficult to understand. We can study communication similar to the way we study other systems. There are elements to the communication process that are important to understand. Each interaction that we have will typically include a sender, receiver, message, channel, feedback, and noise. Let's take a closer look at each one.

Sender

Humans encode messages naturally, and we don't often consider this part of the process. However, if you have ever thought about the exact words that you would use to get a later curfew from your parents/guardians and how you might refute any counterpoints, then you intuitively know that choosing the right words - "encoding" - weighed heavily in your ability to influence your parents/guardians successfully. The language you chose mattered.

The sender is the encoder or source of the message. The sender is the person who decides to communicate and the intent of the message. The source may decide to send messages to entertain, persuade, inform, include, or escape. Often, the sources will create a message based on their feelings, thoughts, perceptions, and past experiences. For instance, if you have feelings of affection towards someone but never communicate those feelings toward that person, they will never know. The sender can withhold or release information.

Receiver

The transactional model of communication teaches us that we are both the sender and receiver simultaneously. The receiver(s) is the individual who decodes the message and tries to understand the source of the message. Receivers have to filter messages based on their attitudes, beliefs, opinions, values, history, and prejudices. People will encode messages through their five senses. We have to pay attention to the source of the message to receive the message. If the receiver does not get the message, then communication did not occur. The receiver needs to obtain a message.

Daily, you will receive several messages. Some of these messages are intentional. And some of these messages will be unintentional. For instance, a person waving in your direction might be waving to someone behind you, but you accidentally think they are waving at you. Some messages will be easy to understand, and some messages will be hard to interpret. Every time a person sends a message, they are also receiving messages simultaneously.

Message

Messages include any type of textual, verbal, and nonverbal aspects of communication, in which individuals give meaning. People send messages intentionally (texting a friend to meet for coffee) or unintentionally (accidentally falling asleep during lectures). Messages can be verbal (saying hello to your parents/guardians), nonverbal (hugging your parents/guardians), or text (words on a computer screen). Essentially, communication is how messages create meaning. Yet, meanings differ among people. For instance, a friend of yours promises to repay you for the money they borrowed, and they say "sorry" for not having any money to give you. You might think they were insincere, but another person might think that it was a genuine apology. People can vary in their interpretations of messages.

Channel

With advances in technology, cell phones act as many different channels of communication at once. Consider that smartphones allow us to talk and text. Also, we can receive communication through Facebook, Twitter, Email, Instagram, Snapchat, Reddit, and Vox. All of these channels are in addition to our traditional channels, which were face-to-face communication, letter writing, telegram, and the telephone. The addition of these new communication channels has changed our lives forever. The channel is the medium in which we communicate our message. Think about breaking up a romantic relationship. Would you rather do it via face-to-face or via a text message? Why did you answer the way that you did? The channel can impact the message.

Now, think about how you hear important news. Do you learn about it from the Internet, social media, television, newspaper, or others? The channel is the medium in which you learn about information.

It may seem like a silly thing to talk about channels, but a channel can make an impact on how people receive the message. For instance, a true story tells about a professional athlete who proposed marriage to his girlfriend by sending her the ring through the postal mail service. He sent her a ring and a recorded message asking her to marry him. She declined his proposal and refused to return the ring.¹⁴ In this case, the channel might have been better if he asked her face-to-face.

Just be mindful of how the channel can affect the way that a receiver reacts and responds to your message. For instance, a handwritten love letter might be more romantic than a typed email. On the other hand, if there was some tragic news about your family, you would probably want someone to call you immediately rather than sending you a letter.

Overall, people naturally know that the message impacts which channel they might use. In a research study focused on channels, college students were asked about the best channels for delivering messages.¹⁵ College students said that they would communicate face-to-face if the message was positive, but use mediated channels if the message was negative.

Feedback

Feedback is the response to the message. If there is no feedback, communication would not be effective. Feedback is important because the sender needs to know if the receiver got the message. Simultaneously, the receiver usually will give the sender some sort of message that they comprehend what has been said. If there is no feedback or if it seems that the receiver did not understand the message, then it is negative feedback. However, if the receiver understood the message, then it is positive feedback. Positive feedback does not mean that the receiver entirely agrees with the sender of the message, but rather the message was comprehended. Sometimes feedback is not positive or negative; it can be ambiguous. Examples of ambiguous feedback might include saying “hmmm” or “interesting.” Based on these responses, it is not clear if the receiver of the message understood part or the entire message. It is important to note that feedback doesn’t have to come from other people. Sometimes, we can be critical of our own words when we write them in a text or say them out loud. We might correct our words and change how we communicate based on our internal feedback.

Environment

The context or situation where communication occurs and affects the experience is referred to as the

environment. We know that the way you communicate in a professional context might be different than in a personal context. In other words, you probably won't talk to your boss the same way you would talk to your best friend. (An exception might be if your best friend was also your boss). The environment will affect how you communicate. For instance, in a library, you might talk more quietly than normal so that you don't disturb other library patrons. However, in a nightclub or bar, you might speak louder than normal due to the other people talking, music, or noise. Hence, the environment makes a difference in the way in which you communicate with others.

It is also important to note that environments can be related to fields of experience or a person's past experiences or background. For instance, a town hall meeting that plans to cut primary access to lower socioeconomic residents might be perceived differently by individuals who use these services and those who do not. Environments might overlap, but sometimes they do not. Some people in college have had many family members who attended the same school, but other people do not have any family members that ever attended college.

Noise

Anything that interferes with the message is called noise. Noise keeps the message from being completely understood by the receiver. If noise is absent, then the message would be accurate. However, usually, noise impacts the message in some way. Noise might be physical (e.g., television, cell phone, fan), or it might be psychological (e.g., thinking about your parents/guardians or missing someone you love). Noise is anything that hinders or distorts the message.

There are four types of noise. The first type is physical noise. This is noise that comes from a physical object. For instance, people talking, birds chirping, a jackhammer pounding concrete, a car revving by, are all different types of physical noise.

The second type of noise is psychological noise. This is the noise that no one else can see unless you are a mind reader. It is the noise that occurs in a person's mind, such as frustration, anger, happiness, or depression. When you talk to a person, they might act and behave like nothing is wrong, but deep inside their mind, they might be dealing with a lot of other issues or problems. Hence, psychological noise is difficult to see or understand because it happens in the other person's mind.

The third type of noise is semantic noise, which deals with language. This could refer to jargon, accents, or language use. Sometimes our messages are not understood by others because of the word choice. For instance, if a person used the word "lit," it would probably depend on the other words accompanying the word "lit" and or the context. To say that "this party is lit" would mean something different compared to "he lit a cigarette." If you were coming from another country, that word might mean something different. Hence, sometimes language-related problems, where the receiver can't understand the message, are referred to as semantic noise.

The fourth and last type of noise is called physiological noise. This type of noise is because the receiver's body interferes or hinders the acceptance of a message. For instance, if the person is blind, they are unable to see any written messages that you might send. If the person is deaf, then they are unable to hear any spoken messages. If the person is very hungry, then they might pay more attention to their hunger than any other message.

MINDFULNESS ACTIVITY

We live in a world where there is constant noise. Practice being mindful of sound. Find a secluded spot



and just close your eyes. Focus on the sounds around you. Do you notice certain sounds more than others? Why? Is it because you place more importance on those sounds compared to other sounds?

Sounds can be helpful to your application of mindfulness.¹⁶ Some people prefer paying attention to sounds rather than their breath when meditating. The purpose of this activity is to see if you can discern some sounds more than others. Some people might find these sounds noisy and very distracting. Others might find the sounds calming and relaxing.

If you watch old episodes of Superman, you might see scenes where he has to concentrate on hearing the sounds of someone calling for help.

Superman can filter all the other sounds in the world to figure out where he needs to focus his attention.

There will be many times in life where you will be distracted because you might be overwhelmed with all the noise. It is essential to take a few minutes, just to be mindful of the noise and how you can deal with all the distractions. Once you are aware of the things that trigger these distractions or noise, then you will be able to be more focused and to be a better communicator.

Key Takeaways

- Communication is a process because senders and receivers act as senders and receivers simultaneously, with the receiver's feedback serving as a key element to continuing the process.
- The components of the communication process involve the source, sender, channel, message, environment, and noise.

Exercises

- Think of your most recent communication with another individual. Write down this conversation and, within the conversation, identify the components of the communication process.
- Think about the different types of noise that affect communication. Can you list some examples of how noise can make communication worse?
- Think about the advantages and disadvantages of different channels. Write down the pros and cons of the different channels of communication.

2.3 Perception Process

LEARNING

OUTCOMES

1. Describe perception and aspects of interpersonal perception.
2. List and explain the three stages of the perception process.
3. Understand the relationship between interpersonal communication and perception.

As you can see from the picture, how you view something is also how you will describe and define it. Your perception of something will determine how you feel about it and how you will communicate about it. In the picture above, do you see it as a six or a nine? Why did you answer the way that you did?

Your perceptions affect who you are, and they are based on your experiences and preferences. If you have a horrible experience with a restaurant, you probably won't go to that restaurant in the future. You might even tell others not to go to that restaurant based on your personal experience. Thus, it is crucial to understand how perceptions can influence others.

Sometimes the silliest arguments occur with others because we don't understand their perceptions of things. Just like the illustration shows, it is important to make sure that you see things the same way that the other person does. In other words, put yourself in their shoes and see it from their perspective before jumping to conclusions or getting upset. That person might have a legitimate reason why they are not willing to concede with you.

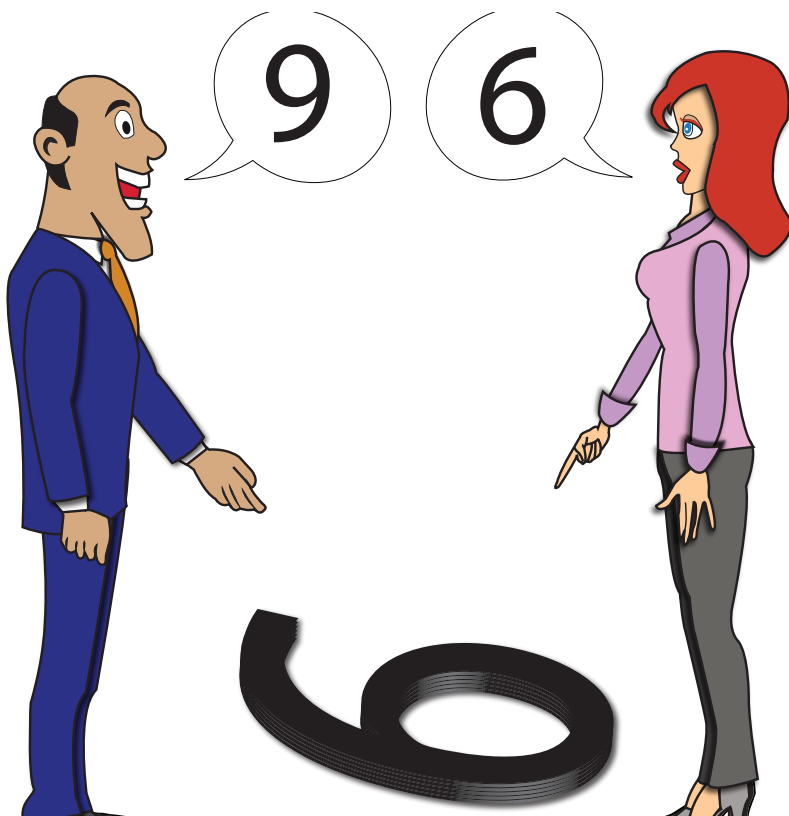

Figure 2.2 It's All About Perception

Perception

Many of our problems in the world occur due to **perception**, or the process of acquiring, interpreting, and organizing information that comes in through your five senses. When we don't get all the facts, it is hard to make a concrete decision. We have to rely on our perceptions to understand the situation. In this section, you will learn tools that can help you understand perceptions and improve your communication skills. As you will see in many of the illustrations on perception, people can see different things. In some of the pictures, some might only be able to see one picture, but there might be others who can see both images, and a small amount might be able to see something completely different from the rest of the class.

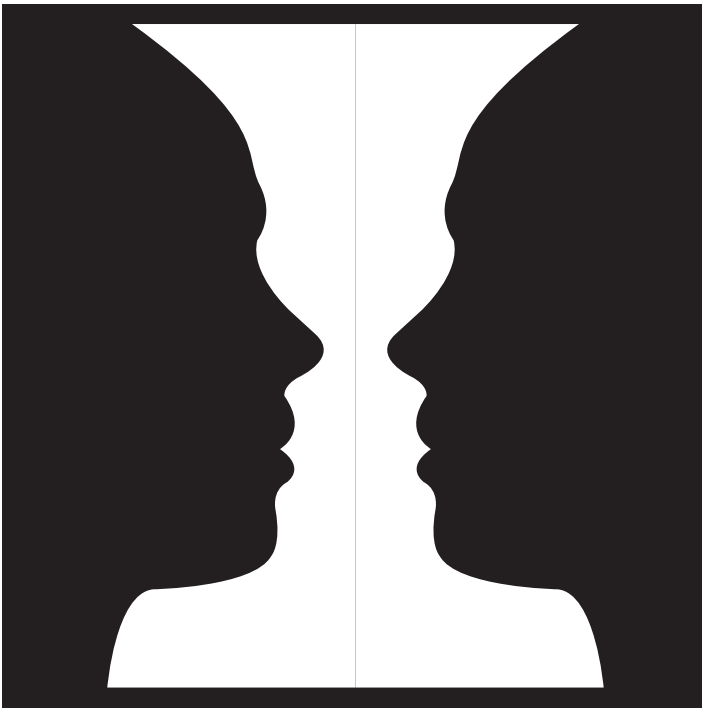

Figure 2.3a The Rubin Vase - based on Edgar John Rubin's (1915) "Vase Ambiguous Figure"

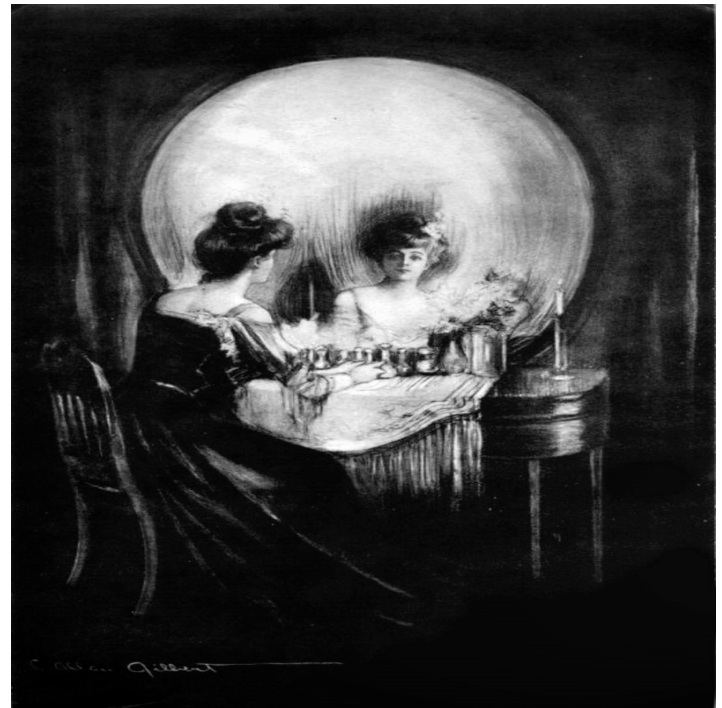

Figure 2.3b Charles Allan Gilbert (1892) "All is Vanity"



Figure 2.3c William Ely Hill (1915) "My Wife and My Mother-in-Law"

Many famous artists over the years have played with people's perceptions. Figure 2.3 is an example of three artists' use of twisted perceptions. The first picture was initially created by Danish psychologist Edgar Rubin and is commonly called The Rubin Vase. Essentially, you have what appears to either be a vase (the white part) or two people looking at each other (the black part). This simple image is both two images and neither image at the same time. The second work of art is Charles Allan Gilbert's (1892) painting "All is Vanity." In this painting, you can see a woman sitting staring at herself in the mirror. At the same time, the image is also a giant skull. Lastly, we have William Ely Hill (1915) "My Wife and My Mother-in-Law," which may have been loosely based on an 1888 German postcard. In Hill's painting, you have two different images, one of a young woman and one of an older woman. The painting was initially published in an American humor magazine called *Puck*. The caption "They are both in this picture - Find them" ran

alongside the picture. These visual images are helpful reminders that we don't always perceive things in the same way as those around us. There are often multiple ways to view and understand the same set of events.

When it comes to interpersonal communication, each time you talk to other people, you present a side of yourself. Sometimes this presentation is a true representation of yourself, and other times it

may be a fake version of yourself. People present themselves how they want others to see them. Some people present themselves positively on social media, and they have wonderful relationships. Then, their followers or fans get shocked to learn when those images are not true to what is presented. If we only see one side of things, we might be surprised to learn that things are different. In this section, we will learn that the perception process has three stages: attending, organizing, and interpreting.

Attending

The first step of the perception process is to select what information you want to pay attention to or focus on, which is called **attending**. You will pay attention to things based on how they look, feel, smell, touch, and taste. At every moment, you are obtaining a large amount of information. So, how do you decide what you want to pay attention to and what you choose to ignore? People will tend to pay attention to things that matter to them. Usually, we pay attention to things that are louder, larger, different, and more complex to what we ordinarily view.

When we focus on a particular thing and ignore other elements, we call it selective perception. For instance, when you are in love, you might pay attention to only that special someone and not notice anything else. The same thing happens when we end a relationship, and we are devastated, we might see how everyone else is in a great relationship, but we aren't.

There are a couple of reasons why you pay attention to certain things more so than others.

The first reason why we pay attention to something is because it is extreme or intense. In other words, it stands out of the crowd and captures our attention, like an extremely good looking person at a party or a big neon sign in a dark, isolated town. We can't help but notice these things because they are exceptional or extraordinary in some way.

Second, we will pay attention to things that are different or contradicting. Commonly, when people enter an elevator, they face the doors. Imagine if someone entered the elevator and stood with their back to the elevator doors staring at you. You might pay attention to this person more than others because the behavior is unusual. It is something that you don't expect, and that makes it stand out more to you. On another note, different could also be something that you are not used to or something that no longer exists for you. For instance, if you had someone very close to you pass away, then you might pay more attention to the loss of that person than to anything else. Some people grieve for an extended period because they were so used to having that person around, and things can be different since you don't have them to rely on or ask for input.

The third thing that we pay attention to is something that repeats over and over again. Think of a catchy song or a commercial that continually repeats itself. We might be more alert to it since it repeats, compared to something that was only said once.

The fourth thing that we will pay attention to is based on our motives. If we have a motive to find a romantic partner, we might be more perceptive to other attractive people than normal, because we are looking for romantic interests. Another motive might be to lose weight, and you might pay more attention to exercise advertisements and food selection choices compared to someone who doesn't have the motive to lose weight. Our motives influence what we pay attention to and what we ignore.

The last thing that influences our selection process is our emotional state. If we are in an angry mood, then we might be more attentive to things that get us angrier. As opposed to, if we are in a happy mood, then we will be more likely to overlook a lot of negativity because we are already happy. Selecting doesn't involve just paying attention to certain cues. It also means that you might be overlooking other things. For instance, people in love will think their partner is amazing and will overlook a lot of their flaws. This

is normal behavior. We are so focused on how wonderful they are that we often will neglect the other negative aspects of their behavior.

Organizing

Look again at the three images in Figure 2.3. What were the first things that you saw when you looked at each picture? Could you see the two different images? Which image was more prominent? When we examine a picture or image, we engage in **organizing** it in our head to make sense of it and define it. This is an example of organization. After we select the information that we are paying attention to, we have to make sense of it in our brains. This stage of the perception process is referred to as organization. We must understand that the information can be organized in different ways. After we attend to something, our brains quickly want to make sense of this data. We quickly want to understand the information that we are exposed to and organize it in a way that makes sense to us.

There are four types of schemes that people use to organize perceptions.¹⁷ First, physical constructs are used to classify people (e.g., young/old; tall/short; big/small). Second, role constructs are social positions (e.g., mother, friend, lover, doctor, teacher). Third, interaction constructs are the social behaviors displayed in the interaction (e.g., aggressive, friendly, dismissive, indifferent). Fourth, psychological constructs are the dispositions, emotions, and internal states of mind of the communicators (e.g., depressed, confident, happy, insecure). We often use these schemes to better understand and organize the information that we have received. We use these schemes to generalize others and to classify information.

Let's pretend that you came to class and noticed that one of your classmates was wildly waving their arms in the air at you. This will most likely catch your attention because you find this behavior strange. Then, you will try to organize or make sense of what is happening. Once you have organized it in your brain, you will need to interpret the behavior.

Interpreting

The final stage of the perception process is **interpreting**. In this stage of perception, you are attaching meaning to understand the data. So, after you select information and organize things in your brain, you have to interpret the situation. As previously discussed in the above example, your friend waves their hands wildly (attending), and you are trying to figure out what they are communicating to you (organizing). You will attach meaning (interpreting). Does your friend need help and is trying to get your attention, or does your friend want you to watch out for something behind you?

We interpret other people's behavior daily. Walking to class, you might see an attractive stranger smiling at you. You could interpret this as a flirtatious behavior or someone just trying to be friendly. Scholars have identified some factors that influence our interpretations:¹⁸

Personal Experience

First, personal experience impacts our interpretation of events. What prior experiences have you had that affect your perceptions? Maybe you heard from your friends that a particular restaurant was really good, but when you went there, you had a horrible experience, and you decided you never wanted to go there again. Even though your friends might try to persuade you to try it again, you might be inclined not to go, because your past experience with that restaurant was not good.

Another example might be a traumatic relationship break up. You might have had a relational partner

that cheated on you and left you with trust issues. You might find another romantic interest, but in the back of your mind, you might be cautious and interpret loving behaviors differently, because you don't want to be hurt again.

Involvement

Second, the degree of involvement impacts your interpretation. The more involved or deeper your relationship is with another person, the more likely you will interpret their behaviors differently compared to someone you do not know well. For instance, let's pretend that you are a manager, and two of your employees come to work late. One worker just happens to be your best friend and the other person is someone who just started and you do not know them well. You are more likely to interpret your best friend's behavior more altruistically than the other worker because you have known your best friend for a longer period. Besides, since this person is your best friend, this implies that you interact and are more involved with them compared to other friends.

Expectations

Third, the expectations that we hold can impact the way we make sense of other people's behaviors. For instance, if you overheard some friends talking about a mean professor and how hostile they are in class, you might be expecting this to be true. Let's say you meet the professor and attend their class; you might still have certain expectations about them based on what you heard. Even those expectations might be completely false, and you might still be expecting those allegations to be true.

Assumptions

Fourth, there are assumptions about human behavior. Imagine if you are a personal fitness trainer, do you believe that people like to exercise or need to exercise? Your answer to that question might be based on your assumptions. If you are a person who is inclined to exercise, then you might think that all people like to work out. However, if you do not like to exercise but know that people should be physically fit, then you would more likely agree with the statement that people need to exercise. Your assumptions about humans can shape the way that you interpret their behavior. Another example might be that if you believe that most people would donate to a worthy cause, you might be shocked to learn that not everyone thinks this way. When we assume that all humans should act a certain way, we are more likely to interpret their behavior differently if they do not respond in a certain way.

Relational Satisfaction

Fifth, relational satisfaction will make you see things very differently. Relational satisfaction is how satisfied or happy you are with your current relationship. If you are content, then you are more likely to view all your partner's behaviors as thoughtful and kind. However, if you are not satisfied in your relationship, then you are more likely to view their behavior as distrustful or insincere. Research has shown that unhappy couples are more likely to blame their partners when things go wrong compared to happy couples.¹⁹

Conclusion

In this section, we have discussed the three stages of perception: attending, organizing, and interpreting. Each of these stages can occur out of sequence. For example, if your parent/guardian had a bad experience at a car dealership based on their interpretation (such as “They overcharged me for the car and they added all these hidden fees.”), then it can influence their future selection (looking for credible and highly rated car dealerships, and then your parent/guardian can organize the information (car dealers are just trying to make money, the assumption is that they think most customers don’t know a lot about cars). Perception is a continuous process, and it is very hard to determine the start and finish of any perceptual differences.

Key Takeaways

- Perception involves attending, organizing, and interpreting.
- Perception impacts communication.
- Attending, organizing, and interpreting have specific definitions, and each is impacted by multiple variables.

Exercises

- Take a walk to a place you usually go to on campus or in your neighborhood. Before taking your walk, mentally list everything that you will see on your walk. As you walk, notice everything on your path. What new things do you notice now that you are deliberately “attending” to your environment?
- What affects your perception? Think about where you come from and your self-concept. How do these two factors impact how you see the world?
- Look back at a previous text or email that you got from a friend. After reading it, do you have a different interpretation of it now compared to when you first got it? Why? Think about how interpretation can impact communication if you didn’t know this person. How does it differ?

2.4 Models of Interpersonal Communication

LEARNING OUTCOMES

1. Differentiate among and describe the various action models of interpersonal communication.
2. Differentiate among and describe the various interactional models of interpersonal communication.
3. Differentiate among and describe the various transactional models of interpersonal communication.

In the world of communication, we have several different models to help us understand what communication is and how it works. A **model** is a simplified representation of a system (often graphic) that highlights the crucial components and connections of concepts, which are used to help people understand an aspect of the real-world. For our purposes, the models have all been created to help us

understand how real-world communication interactions occur. The goal of creating models is three-fold:

1. to facilitate understanding by eliminating unnecessary components,
2. to aid in decision making by simulating “what if” scenarios, and
3. to explain, control, and predict events on the basis of past observations.²⁰

Over the next few paragraphs, we’re going to examine three different types of models that communication scholars have proposed to help us understand interpersonal interactions: action, interactional, and transactional.

Action Models

In this section, we will be discussing different models to understand interpersonal communication. The purpose of using models is to provide visual representations of interpersonal communication and to offer a better understanding of how various scholars have conceptualized it over time. The first type of model we’ll be exploring are **action models**, or communication models that view communication as a one-directional transmission of information from a source or sender to some destination or receiver.

Shannon-Weaver Model

Shannon and Weaver were both engineers for the Bell Telephone Labs. Their job was to make sure that all the telephone cables and radio waves were operating at full capacity. They developed the Shannon-

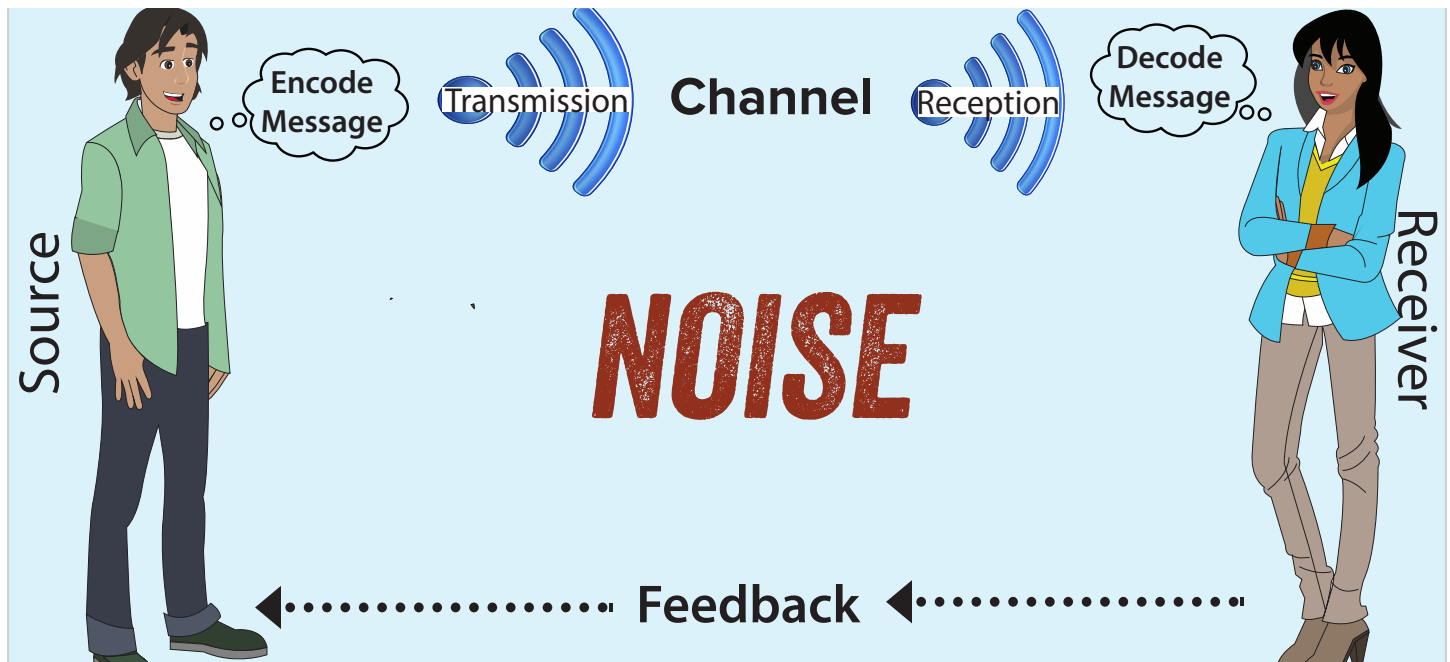

Figure 2.4 Shannon-Weaver Model

Weaver model, which is also known as the linear communication model (Weaver & Shannon, 1963).²¹ As indicated by its name, the scholars believed that communication occurred in a linear fashion, where a sender encodes a message through a channel to a receiver, who will decode the message. Feedback is not immediate. Examples of linear communication were newspapers, radio, and television.

Early Schramm Model

The Shannon-Weaver model was criticized because it assumed that communication always occurred linearly. Wilbur Schram (1954) felt that it was important to notice the impact of messages.²² Schramm's model regards communication as a process between an encoder and a decoder. Most importantly, this model accounts for how people interpret the message. Schramm argued that a person's background, experience, and knowledge are factors that impact interpretation. Besides, Schramm believed that the messages are transmitted through a medium. Also, the decoder will be able to send feedback about the message to indicate that the message has been received. He argued that communication is incomplete unless there is feedback from the receiver. According to Schramm's model, encoding and decoding are vital to effective communication. Any communication where decoding does not occur or feedback does not happen is not effective or complete.

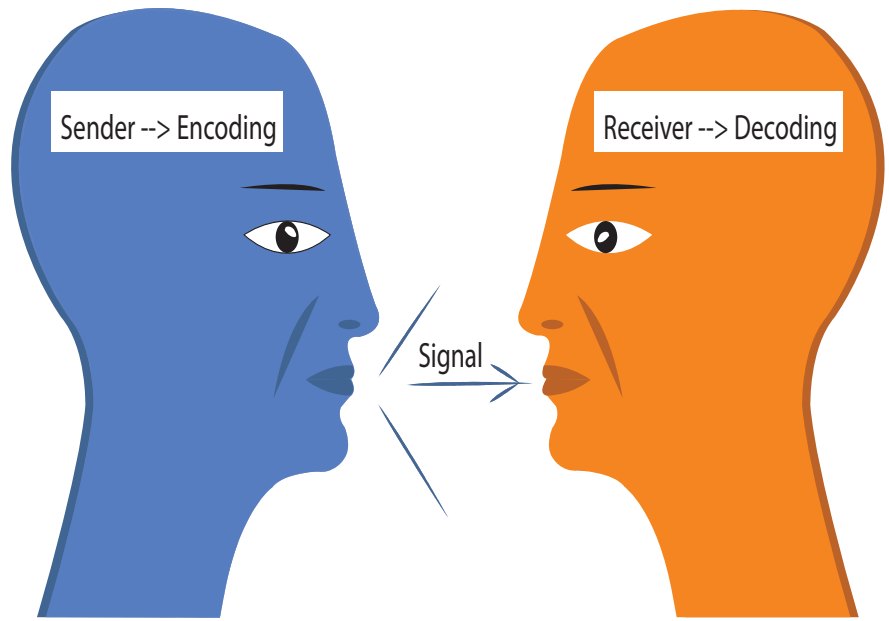

Figure 2.5 Schramm Model

Berlo's SMCR Model

David K. Berlo (1960)²³ created the SMCR model of communication. SMCR stands for sender, message, channel, receiver. Berlo's model describes different components of the communication process. He argued that there are three main parts of all communication, which is the speaker, the subject, and the listener. He maintained that the listener determines the meaning of any message.

In regards to the source or sender of the message, Berlo identified factors that influence the source of the message. First, communication skills refer to the ability to speak or write. Second, attitude is the person's point-of-view, which may be influenced by the listener. The third is whether the source has requisite knowledge on a given topic to be effective. Fourth, social systems include the source's values, beliefs, and opinions, which may influence the message.

Next, we move onto the message portion of the model. The message can be sent in a variety of ways, such as text, video, speech. At the same time, there might be components that influence the message, such as content, which is the information being sent. Elements refer to the verbal and nonverbal behaviors of how the message is sent. Treatment refers to how the message was presented. The structure is how the message was organized. Code is the form in which the message was sent, such as text, gesture, or music.

The channel of the message relies on the basic five senses of sound, sight, touch, smell, and taste. Think of how your mother might express her love for you. She might hug you (touch) and say, "I love you" (sound), or make you your favorite dessert (taste). Each of these channels is a way to display affection.

The receiver is the person who decodes the message. Similar to the models discussed earlier, the receiver is at the end. However, Berlo argued that for the receiver to understand and comprehend the

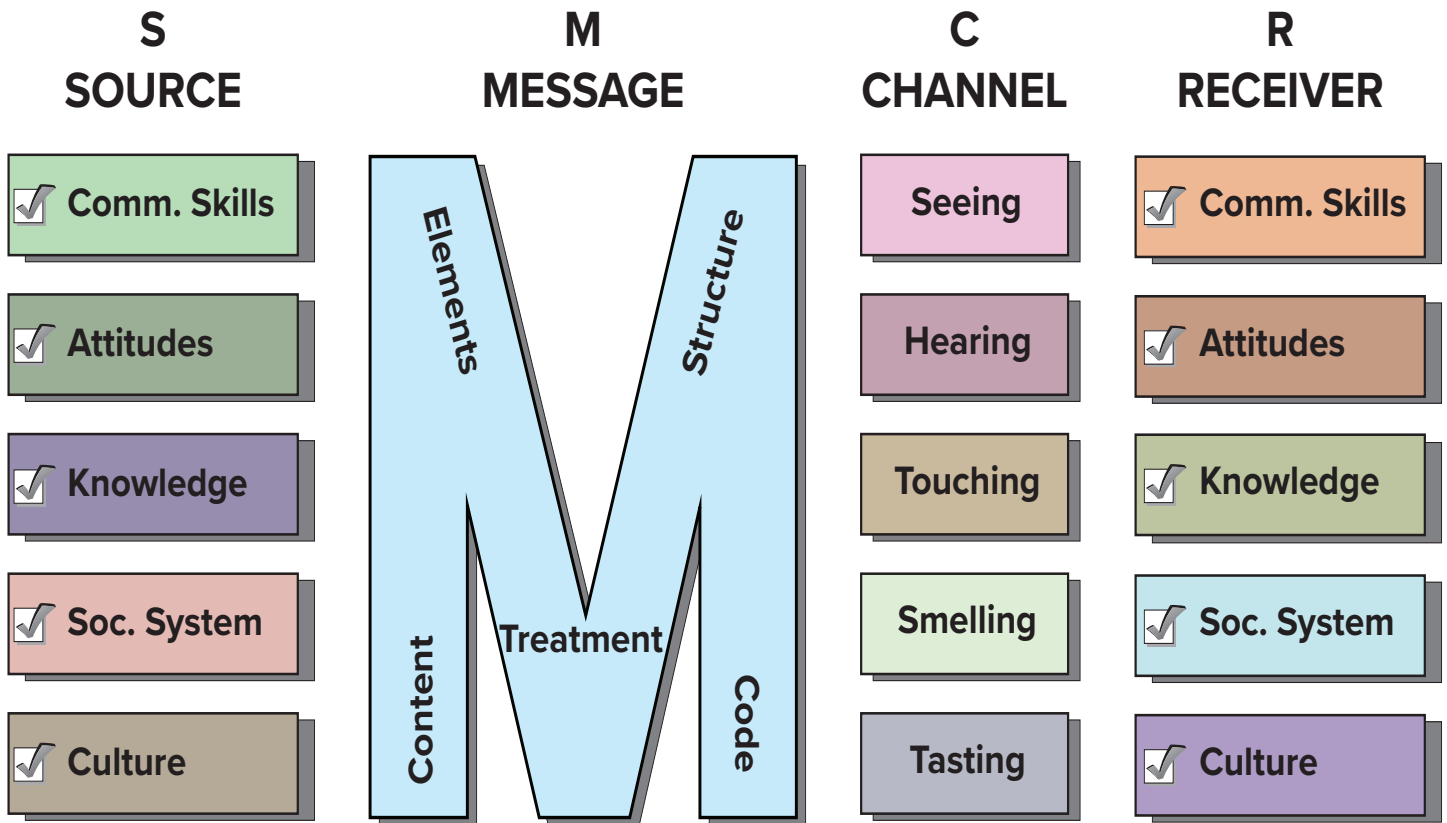

Figure 2.5 SMCR Model

message, there must be similar factors to the sender. Hence, the source and the receiver have similar components. In the end, the receiver will have to decode the message and determine its meaning. Berlo tries to present the model of communication as simple as possible. His model accounts for variables that will obstruct the interpretation of the model.

Interaction Models

In this section, we're going to explore the next evolution of communication models, interaction models. **Interaction models** view the sender and the receiver as responsible for the effectiveness of the communication. One of the biggest differences between the action and interaction models is a heightened focus on feedback.

Osgood and Schramm Model

Osgood-Schramm's model of communication is known as a circular model because it indicates that messages can go in two directions.²⁴ Hence, once a person decodes a message, then they can encode it and send a message back to the sender. They could continue encoding and decoding into a continuous cycle. This revised model indicates that: 1) communication is not linear, but circular; 2) communication is reciprocal and equal; 3) messages are based on interpretation; 4) communication involves encoding, decoding, and interpreting. The benefit of this model is that the model illustrates that feedback is cyclical. It also shows that communication is complex because it accounts for interpretation. This model also showcases the fact that we are active communicators, and we are active in interpreting the messages that we receive.

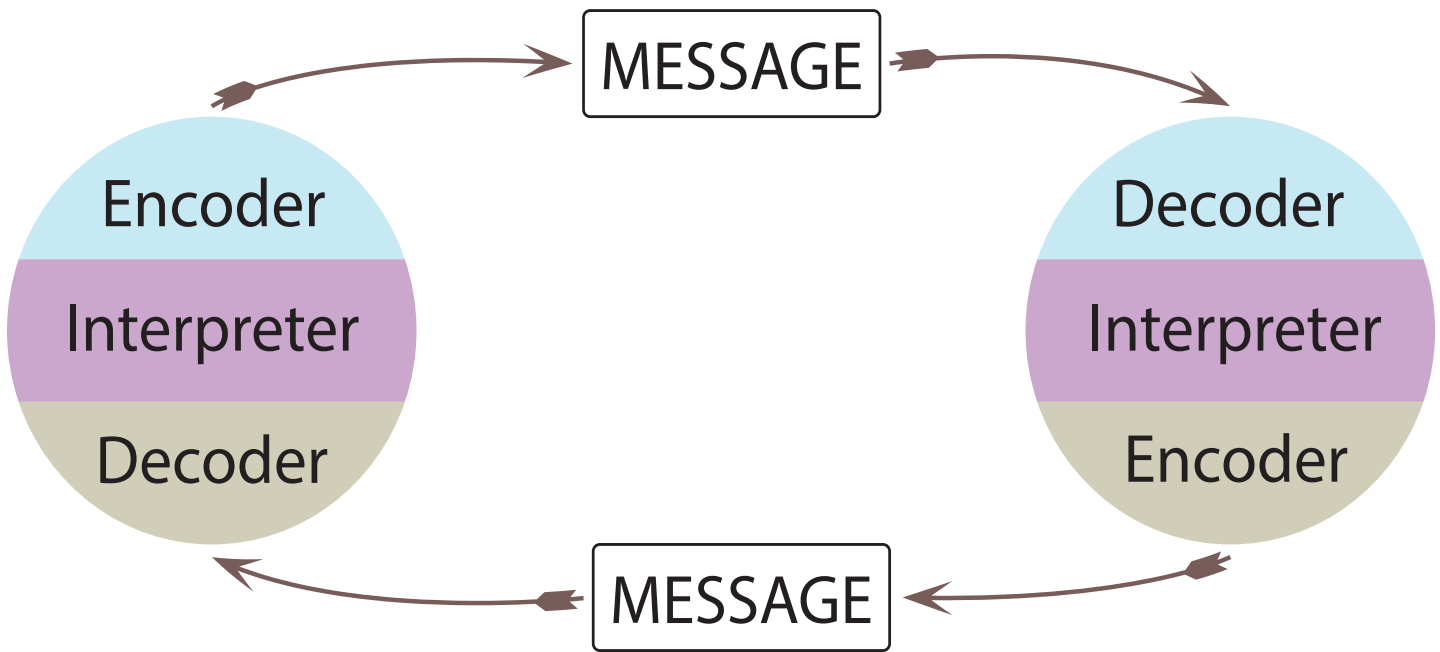

Figure 2.7 Osgood-Schramm Model

Watzlawick, Beavin, and Jackson Model

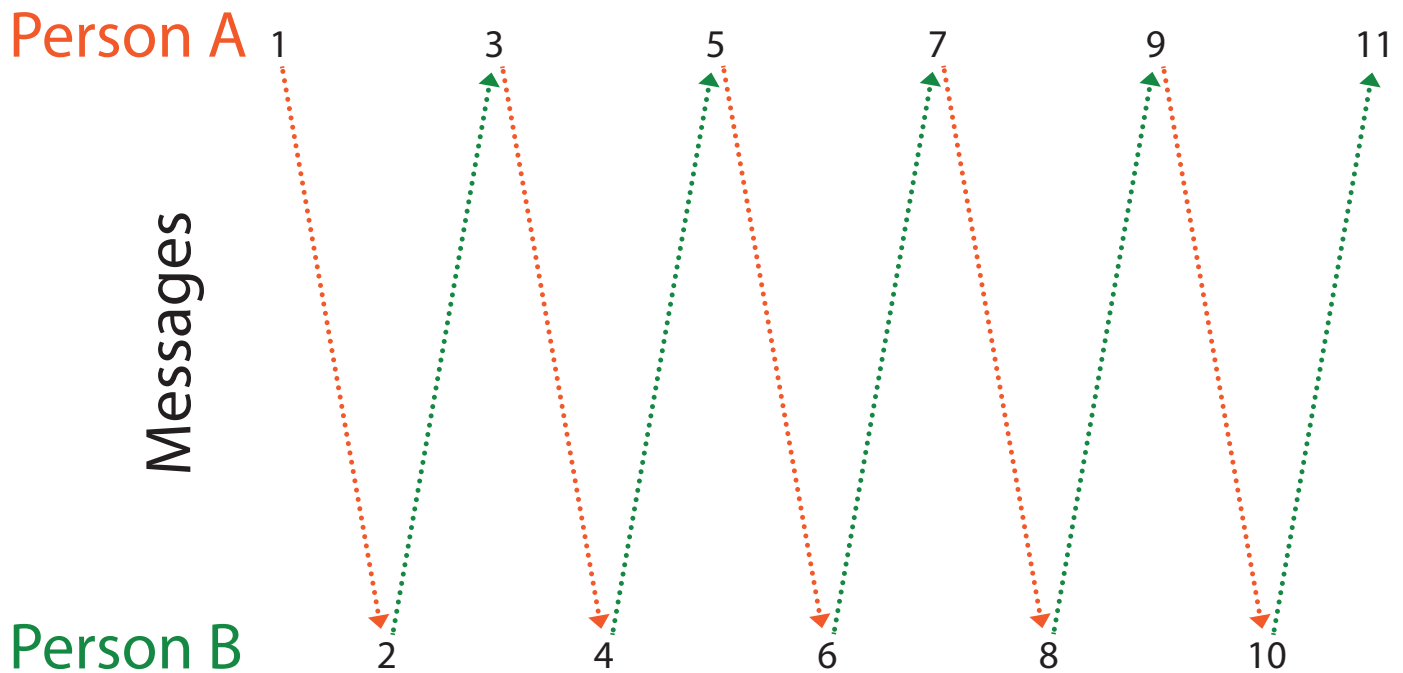

Figure 2.8 Watzlawick-Beavin-Jackson Model

Watzlawick, Beavin, and Jackson argued that communication is continuous.²⁵ The researchers argued that communication happens all the time. Every time a message is sent, then a message is returned, and it continues from Person A to Person B until someone stops. Feedback is provided every time that Person A sends a message. With this model, there are five axioms.

First, one cannot, not communicate. This means that everything one does has communicative value. Even if people do not talk to each other, then it still communicates the idea that both parties do not

want to talk to each other. The second axiom states that every message has a content and relationship dimension. Content is the informational part of the message or the subject of discussion. The relationship dimension refers to how the two communicators feel about each other. The third axiom is how the communicators in the system punctuate their communicative sequence. The scholars observed that every communication event has a stimulus, response, and reinforcement. Each communicator can be a stimulus or a response. Fourth, communication can be analog or digital. Digital refers to what the words mean. Analogical is how the words are said or the nonverbal behavior that accompanies the message. The last axiom states that communication can be either symmetrical or complementary. This means that both communicators have similar power relations, or they do not. Conflict and misunderstandings can occur if the communicators have different power relations. For instance, your boss might have the right to fire you from your job if you do not professionally conduct yourself.

Transaction Models

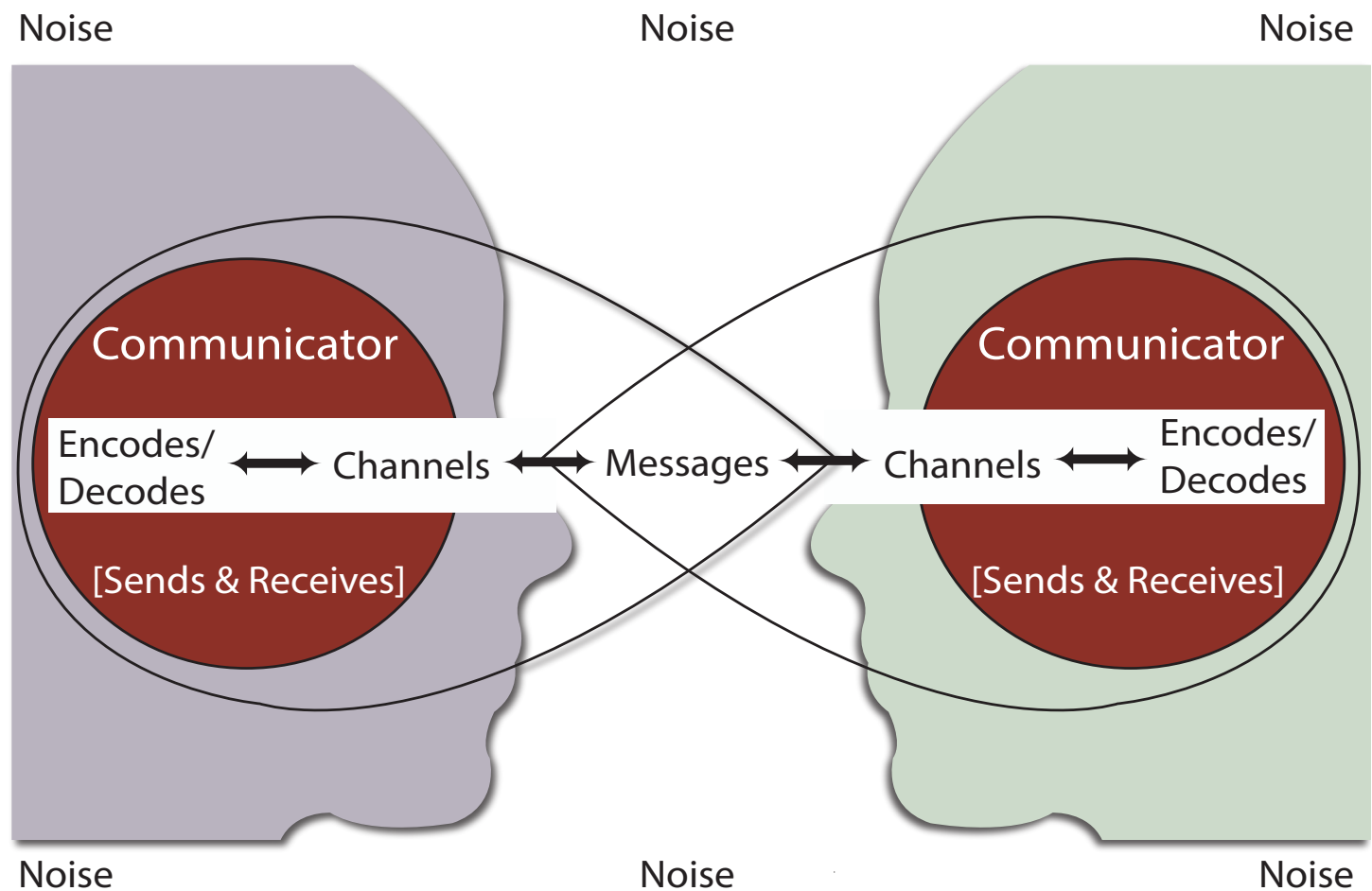

Figure 2.9 Transactional Model of Communication

The transactional models differ from the interactional models in that the transactional models demonstrate that individuals are often acting as both the sender and receiver simultaneously. Basically, sending and receiving messages happen simultaneously.

Barnlund's Transactional Model

In 1970, Dean C. Barnlund created the transactional model of communication to understand basic interpersonal communication.²⁶ Barnlund argues that one of the problems with the more linear models of communication is that they resemble mediated messages. The message gets created, the message is sent, and the message is received. For example, we write an email, we send an email, and the email is read. Instead, Barnlund argues that during interpersonal interactions, we are both sending and receiving messages simultaneously. Out of all the other communication models, this one includes a multi-layered feedback system. We can provide oral feedback, but our nonverbal communication (e.g., tone of voice, eye contact, facial expressions, gestures) is equally important to how others interpret the messages we are sending we use others' nonverbal behaviors to interpret their messages. As such, in any interpersonal interaction, a ton of messages are sent and received simultaneously between the two people.

The Importance of Cues

The main components of the model include cues. There are three types of cues: public, private, and behavioral. Public cues are anything that is physical or environmental. Private cues are referred to as the private objects of the orientation, which include the senses of a person. Behavioral cues include nonverbal and verbal cues.

The Importance of Context

Furthermore, the transactional model of communication has also gone on to represent that three contexts coexist during an interaction:

1. **Social Context:** The rules and norms that govern how people communicate with one another.
2. **Cultural Context:** The cultural and co-cultural identities people have (e.g., ability, age, biological sex, gender identity, ethnicity, nationality, race, sexual orientation, social class).
3. **Relational Context:** The nature of the bond or emotional attachment between two people (e.g., parent/guardian-child, sibling-sibling, teacher-student, health care worker-client, best friends, acquaintances).

Through our interpersonal interactions, we create social reality, but all of these different contexts impact this reality.

The Importance of Noise

Another important factor to consider in Barnlund's Transactional Model is the issue of noise, which includes things that disturb or interrupt the flow of communication. Like the three contexts explored above, there are another four contexts that can impact our ability to interact with people effectively:²⁷

1. **Physical Context:** The physical space where interaction is occurring (office, school, home, doctor's office, is the space loud, is the furniture comfortable, etc.).
2. **Physiological Context:** The body's responses to what's happening in its environment.
 - a. **Internal:** Physiological responses that result because of our body's internal processes (e.g., hunger, a headache, physically tired).
 - b. **External:** Physiological responses that result because of external stimuli within the environment (e.g., are you cold, are you hot, the color of the room, are you physically comfortable).

3. **Psychological Context:** How the human mind responds to what's occurring within its environment (e.g., emotional state, thoughts, perceptions, intentions, mindfulness).
4. **Semantic Context:** The possible understanding and interpretation of different messages sent (e.g., someone's language, size of vocabulary, effective use of grammar).

In each of these contexts, it's possible to have things that disturb or interrupts the flow of communication. For example, in the physical context, hard plastic chairs can make you uncomfortable and not want to sit for very long talking to someone. Physiologically, if you have a headache (internal) or if a room is very hot, it can make it hard to concentrate and listen effectively to another person. Psychologically, if we just broke up with our significant other, we may find it difficult to sit and have a casual conversation with someone while our brains are running a thousand miles a minute. Semantically, if we don't understand a word that someone uses, it can prevent us from accurately interpreting someone's messages. When you think about it, with all the possible interference of noise that exists within an interpersonal interaction, it's pretty impressive that we ever get anything accomplished.

More often than not, we are completely unaware of how these different contexts create noise and impact our interactions with one another during the moment itself. For example, think about the nature of the physical environments of fast-food restaurants versus fine dining establishments. In fast-food restaurants, the décor is bright, the lighting is bright, the seats are made of hard surfaces (often plastic), they tend to be louder, etc. This noise causes people to eat faster and increase turnover rates. Conversely, fine dining establishments have tablecloths, more comfortable chairs, dimmer lighting, quieter dining, etc. The physical space in a fast-food restaurant hurries interaction and increases turnover. The physical space in the fine dining restaurant slows our interactions, causes us to stay longer, and we spend more money as a result. However, most of us don't pay that much attention to how physical space is impacting us while we're having a conversation with another person.

Although we used the external environment here as an example of how noise impacts our interpersonal interactions, we could go through all of these contexts and discuss how they impact us in ways of which we're not consciously aware. We'll explore many of these contexts throughout the rest of this book.

Transaction Principles

As you can see, these models of communication are all very different. They have similar components, yet they are all conveyed very differently. Some have features that others do not. Nevertheless, there are transactional principles that are important to learn about interpersonal communication.

Communication is Complex

People might think that communication is easy. However, there are a lot of factors, such as power, language, and relationship differences, that can impact the conversation. Communication isn't easy, because not everyone will have the same interpretation of the message. You will see advertisements that some people will love and others will be offended by. The reason is that people do not identically receive a message.

Communication is Continuous

In many of the communication models, we learned that communication never stops. Every time a source sends a message, a receiver will decode it, and it goes back-and-forth. It is an endless cycle, because even if one person stops talking, then they have already sent a message that the communication needs to end.

As a receiver, you can keep trying to send messages, or you can stop talking as well, which sends the message to the other person that you also want to stop talking.

Communication is Dynamic

With new technology and changing times, we see that communication is constantly changing. Before social media, people interacted very differently. Some people have suggested that social media has influenced how we talk to each other. The models have changed over time because people have also changed how they communicate. People no longer use the phone to call other people; instead, they will text message others because they find it easier and less evasive.

Final Note

The advantage of this model is it shows that there is a shared field of experience between the sender and receiver. The transactional model shows that messages happen simultaneously with noise. However, the disadvantages of the model are that it is complex, and it suggests that the sender and receiver should understand the messages that are sent to each other.

Towards a Model of Mindful Communication

So, what ultimately does a model of mindful communication look like? Well, to start, we think mindful communication is very similar to the transactional model of human communication. All of the facets of transactional communication can be applied in this context as well. The main addition to the model of mindful communication is coupling what we already know about the transactional model with what we learned in Chapter 1 about mindfulness. In Figure 2.9, we have combined the transactional model with Shauna Shapiro and Linda Carlson's three parts of mindful practice: attention, intention, and attitude.²⁸

We're not proposing a new model of communication in this text; we're proposing a new way of coupling interpersonal communication with mindfulness. So, how would mindful interpersonal communication work? According to Levine Tatkin, "Mindful communication is all about being more conscious about the way you interact with the other person daily. It is about being more present when the other person is communicating to you."²⁹ As such, we argue that mindful communication is learning to harness the power of mindfulness to focus our ability to communicate with other people interpersonally effectively.

Many of us engage in mindless communication every day. We don't pay attention to the conversation; we don't think about our intentions during the interaction; and we don't analyze our attitudes while we talk. Have you ever found yourself doing any of the following during an interpersonal interaction?

- Constantly checking your smartphone.
- Focusing on anything but the other person talking.
- Forming your responses before the other person stops talking.
- Cutting the other person off while they are talking.
- Constantly interrupting the other person while they are talking.
- Getting impatient when the other person doesn't "get to the point fast enough."
- Trying to come up with solutions the person never asked for.
- Getting bored.
- Having biases against the other person or their ideas without really listening to them.
- Starting arguments for no reason.
- Finding yourself yelling or screaming at someone else.

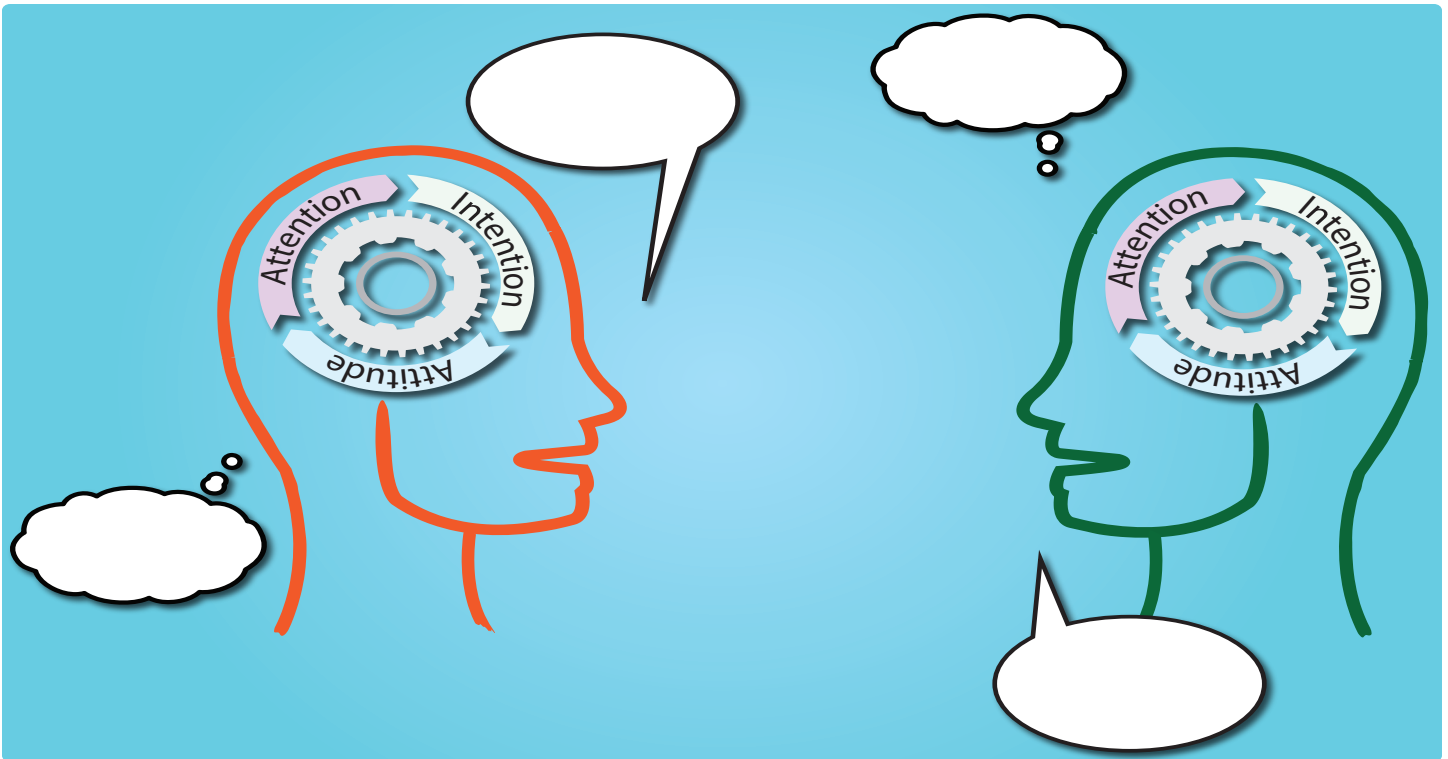

Figure 2.10 Model of Mindful Communication

- Refusing to “give in” or “find the middle ground” when engaged in conflict.

These are just a few examples of what mindless interpersonal interactions can look like when we don’t consider the attention, intention, and attitude. Mindful interpersonal communication, on the other hand, occurs when we engage in the following communication behaviors:³⁰

- Listening to your partner without being distracted.
- Holding a conversation without being too emotional.
- Being non-judgmental when you talk, argue, or even fight with your partner.
- Accepting your partner’s perspective even if it is different from yours.
- Validating yourself and your partner.

The authors of this text truly believe that engaging in mindful interpersonal communicative relationships is very important in our day-to-day lives. All of us are bombarded by messages, and it’s effortless to start treating all messages as if they were equal and must be attended to within a given moment. Let’s look at that first mindless behavior we talked about earlier, checking your cellphone while you’re talking to people. As we discussed in Chapter 1, our minds have a habit of wandering 47% of the time.³¹ Our monkey brains are constantly jumping from idea to idea before we add in technology. If you’re continually checking your cellphone while you’re talking to someone, you’re allowing your brain to roam even more than it already does.

Effective interpersonal communication is hard. The goal of a mindful approach to interpersonal communication is to train ourselves to be in the moment with someone listening and talking. We’ll talk more about listening and talking later in this text. For now, we’re going to wrap-up this chapter by looking at some specific skills to enhance your interpersonal communication.

Key Takeaways

- In action models, communication was viewed as a one-directional transmission

of information from a source or sender to some destination or receiver. These models include the Shannon and Weaver Model, the Schramm Model and Berlo's SMCR model.

- Interactional models viewed communication as a two-way process, in which both the sender and the receiver equally share the responsibility for communication effectiveness. Examples of the interactional model are Watzlawick, Beavin, and Jackson Model and Osgood and Schramm Model.
- The transactional models differ from the interactional models in that the transactional models demonstrate that individuals are often acting as both the sender and receiver simultaneously. An example of a transactional model is Barnlund's model.

Exercises

- Choose one action model, one interactional model, and Barnlund's transactional model. Use each model to explain one communication scenario that you create. What are the differences in the explanations of each model?
- Choose the communication model with which you most agree. Why is it better than the other models?

2.5 Interpersonal Communication Skills

LEARNING OUTCOMES

1. Understand the skills associated with effective interpersonal skills.
2. Explain how to improve interpersonal skills.
3. Describe the principles of ethical communication.

In this chapter, we have learned about different aspects of interpersonal communication. Overall, some skills can make you a better interpersonal communicator. We will discuss each one in more detail below.

Listening Skills

The most important part of communication is not the actual talking, but the listening part. If you are not a good listener, then you will not be a good communicator. One must engage in mindful listening. Mindful listening is when you give careful and thoughtful attention to the messages that you receive. People will often listen mindfully to important messages or to people that matter most. Think about how happy you get when you are talking to someone you really love or maybe how you pay more attention to what a professor says if they tell you it will be on the exam. In each of these scenarios, you are giving the speaker your undivided attention. Most of our listening isn't mindful, but there will be times where it will

be important to listen to what others are telling us so that we can fulfill our personal and/or professional goals. We'll discuss listening in more detail in Chapter 7.

People Skills

People skills are a set of characteristics that will help you interact well with others.³² These skills are most important in group situations and where cooperation is needed. These skills can also relate to how you handle social situations. They can make a positive impact on career advancement but also in relationship development.³³ One of the most essential people skills to have is the ability to understand people. Being able to feel empathy or sympathy to another person's situation can go a long way. By putting yourself in other people's shoes and understanding their hardships or differences, you can put things into perspective. It can help you build a stronger and better interpersonal relationship.

Emotional Intelligence

Emotional intelligence (EQ) is the ability to recognize your own emotions and the emotions of others.³⁴ Emotionally intelligent people can label their feelings appropriately and use this information to guide their behavior. EQ is highly associated with the ability to empathize with others. Furthermore, EQ can help people connect interpersonally. Research has demonstrated that people with higher levels of EQ are more likely to succeed in the workplace and have better mental health. They are often better leaders and effective managers of conflict. We'll discuss the idea of EQ in more detail in Chapter 3.

Appropriate Skill Selection

The best interpersonal communicators are the ones who can use the appropriate skill in certain contexts. For instance, if it is a somber event, then they might not laugh. Or if it is a joyful occasion, they might not cry hysterically, unless they are tears of joy. The best politicians can sense the audience and determine what skills would be appropriate for which occasion. We know that humor can be beneficial in certain situations. However, humor can also be inappropriate for certain people. It is essential to know what skill is appropriate to use and when it is necessary to use it.

Communicating Ethically

The last interpersonal skill involves communication **ethics**. We have seen several people in the business world that have gotten in trouble for not communicating ethically. It is important to be mindful of what you say to others. You do not want people to think you are deceptive or that you are lying to them. Trust is a hard thing to build. Yet, trust can be taken away from you very quickly. It is essential that every time you communicate, you should consider the ethics behind your words. As we will see throughout this book, words matter! So, what does it mean to communicate ethically interpersonally? Thankfully, the National Communication Association has created a general credo for ethical communication.³⁵ The subheadings below represent the nine statements created by the National Communication Association to help guide conversations related to communication ethics.

We advocate truthfulness, accuracy, honesty, and reason as essential to the integrity of communication.

The first statement in the credo for ethical communication is one that has taken on a lot more purpose in the past few years, being truthful. We live in a world where the blurring of fact and fiction, real-life and fantasy, truth and lies, real news and fake news, etc. has become increasingly blurry. The NCA credo argues that ethical communication should always strive towards truth and integrity. As such, it's important to consider our interpersonal communication and ensure that we are not spreading lies.

We endorse freedom of expression, diversity of perspective, and tolerance of dissent to achieve the informed and responsible decision making fundamental to a civil society.

You don't have to agree with everyone. In fact, it's perfectly appropriate to disagree with people and do so in a civilized manner. So much of our interpersonal communication in the 21st Century seems to have become about shouting, "I'm right, you're wrong." As such, it's important to remember that it's possible for many different vantage points to have equal value. From an ethical perspective, it's very important to listen to others and not immediately start thinking about our comebacks or counter-arguments. When we're only focused on our comebacks and counter-arguments, then we're not listening effectively. Now, we are not arguing that people should have the right to their own set of facts. As we discussed in the previous statement, we believe in facts and think the idea of "alternative facts" is horrific. But often, people's experiences in life lead them to different positions that can be equally valid.

We strive to understand and respect other communicators before evaluating and responding to their messages.

Along with what was discussed in the previous statement, it's important to approach our interpersonal interactions from a position of understanding and respect. Part of the mindfulness approach to interpersonal communication that we've advocated for in this book involves understanding and respect. Too many people in our world today immediately shut down others with whom they disagree without ever giving the other person a chance. We know that it can be tough to listen to messages that you strongly disagree with, but we can still disagree and, at the end of the day, respect each other.

We promote access to communication resources and opportunities as necessary to fulfill human potential and contribute to the well-being of individuals, families, communities, and society.

As communication scholars, we believe that everyone should have the opportunity to improve their communication. One of the reasons we've written this book is because we believe that all students should have access to an interpersonal communication textbook that is free. Furthermore, we believe that everyone should have the opportunity to develop their interpersonal communication skills, listening skills, presentation skills, and social skills. Ultimately, developing communication skills helps people in their interpersonal relationships and makes them better people as a whole. According to Sherwyn Morreale, Joseph Valenzano, and Janessa Bauer:

Communication can help couples connect on a deeper level and feel more satisfied with their relationships. Additionally, competent communication strengthens bonds among family members and helps them cope with conflict and stressful situations. Communication gives family members the tools

they need to express their feelings and address their concerns in a constructive way, which ultimately helps when conflicts and stressful situations arise... Better interpersonal communication can improve the social health of a community by strengthening relationships among various community members.³⁶

We promote communication climates of caring and mutual understanding that respect the unique needs and characteristics of individual communicators.

As communicators, we need to take a two-pronged approach to our interpersonal interactions. First, we need to care about the needs of others. We need to understand that our communication can either build people up or tear them down. We should strive to build people up through our interactions with them. This doesn't mean that there aren't times when you have to tell people that they're wrong, but there are ways of doing this that correct people without attacking their self-esteem.

Second, we need to strive for mutual understanding. As we've learned in this chapter, a lot of things can make communication with each other very difficult. However, we should strive to ensure that our messages are interpreted correctly by others and that we're interpreting others' messages correctly as well. We should avoid jumping to conclusions and assuming that someone's messages are always ill-intended.

We condemn communication that degrades individuals and humanity through distortion, intimidation, coercion, and violence, and through the expression of intolerance and hatred.

We believe that any communication that degrades another person should be seen as reprehensible by everyone. For many of us, it's easy for us to clearly label obvious hate messages as disgusting (e.g., anti-immigrant signs, burning crosses, racist graffiti). However, many people engage in biased language without really realizing that it's happening. We'll discuss the issue of biased language and how to avoid it in more detail in Chapter 4.

We are committed to the courageous expression of personal convictions in pursuit of fairness and justice.

We live in a world where injustices are still very prevalent. From anti-immigrant rhetoric to laws preventing medical treatment for transgender people, we believe that it's important for people to pursue fairness and justice in our world today. As such, all of us need to remember this when we are interacting with others. Whether it's remembering to call someone by their preferred pronouns or supporting individuals seeking equal rights and protection under the law, we should help those individuals.

We advocate sharing information, opinions, and feelings when facing significant choices while also respecting privacy and confidentiality.

We live in a world where we faced with innumerable choices about the future. As I'm writing this, I'm currently in self-imposed quarantine during the coronavirus outbreak of Spring 2020. During this period, we've all become used to the term "social distancing," or avoiding large crowds of people and keeping at least six feet from others in public. During this period, there are a lot of strong opinions and

feelings on this subject. When it comes to our interpersonal interactions, it's important for people to share information, opinions, and feelings and not have them immediately dismissed. Again, this is not to say that we believe that people should have the right to their own facts, but people should be allowed to express their own opinions and feelings.

In addition to sharing information, opinions, and feelings, it's important to remember to respect people's privacy and confidentiality. Not everything we hear from another person is meant to be broadcast openly to the world. It's important to remember not to tell other people's business.

We accept responsibility for the short- and long-term consequences for our own communication and expect the same of others.

Lastly, the National Communication Association's Credo for Ethical Communication advocates that people take responsibility for the consequences of their communication. If you say something that hurts someone else's feelings, it's important to recognize that and apologize. If we accidentally spread false information, it's important to correct the facts when we learn them.

Rodrick Hart and Don Burks coined the term "rhetorical sensitivity" to help explain awareness of our own communicative behaviors. According to Hart and Burks,

The rhetorically sensitive person (a) tries to accept role-taking as part of the human condition, (b) attempts to avoid stylized verbal behavior, (c) is characteristically willing to undergo the strain of adaptation, (d) seeks to distinguish between all information and that information acceptable for communication, and (e) tries to understand that an idea can be rendered in multi-form ways.³⁷

When it comes to the ethicality of our communicative choices, it's important to be rhetorically sensitive to more fully understand the short- and long-term consequences that arise from our communicative behaviors.

Key Takeaways

- Skills associated with effective interpersonal communication are listening skills, people skills, emotional intelligence, appropriate skill selection, and ethical communication.
- Improving interpersonal communication skills requires practice and deliberate effort. The ability to identify problems and select appropriate communication skills is key to effective interpersonal communication.
- A set of principles guides ethical communication. These principles teach us that we must respect others, attempt to see the viewpoint of others, take responsibility for our communication, and make an effort to continually improve upon our skills.
-

Exercises

- Recall a situation in which you experienced conflict. Now that you know some approaches to effective interpersonal communication evaluate the experience you recalled and write down what you could have done differently.

- Recall a situation in which your confidence has been broken. In other words, you asked someone to keep a secret and they didn't. How did this make you feel? In what situations is it acceptable to violate the confidence of another person?
- We all do something well in relation to communication. What are your best communication skills? In what areas would you like to improve?

Chapter Wrap-Up

In this chapter, we have learned about various things that can impact interpersonal communication. We learned that Maslow's Hierarchy of Needs can impact how messages are received. We learned about the perception process and the three states of the perception process: attending, interpreting, and organizing. We also discussed the various communication models to understand how the process of communication looks in interpersonal situations. Lastly, we briefly overviewed interpersonal communication skills.

End of Chapter

KEY TERMS

- Action Model
- Attending
- Channel
- Emotional Intelligence
- Environment
- Ethics
- Feedback
- Interaction Model
- Interpreting
- Maslow's Hierarchy of Needs
- Model
- Noise
- Organizing
- Perception
- Receiver
- Self-Concept
- Source
- Transactional Model
- Uncertainty Reduction Theory
- Symbol

REAL WORLD CASE STUDY

Addie and Patrick had been dating for 13 months. They discussed getting married and whether they might have children. One day, it came to light that Patrick had not been paying his credit card bill as he said he would. Addie approached him to ask about the situation. He became very angry with her and a huge fight ensued. They both called each other names and spoke to each other in ways they never expected. After the fight, Addie and Patrick apologized to one another and promised never to talk that way again to each other. Which principle of communication might Addie and Patrick consider as they move forward in their relationship?

END OF CHAPTER QUIZ

1. Paul tells Jenna that her last name must be Campbell, because she is “Mmmm...good.” Paul is trying to _____ the message to Jenna.
 - a. encode
 - b. decode
 - c. provide feedback
 - d. provide noise
 - e. none of these

2. Larry is very hungry because he skipped breakfast. He can't pay attention to other people because he is focused on his hunger. This type of noise is:
 - a. physical
 - b. semantic
 - c. psychological
 - d. physiological
 - e. none of these

3. Which type of schema focuses on the social position?
 - a. physical
 - b. role
 - c. interaction
 - d. behavior
 - e. psychological

4. Kara pays attention to advertisements about cars, because she is looking to buy a new car. The reason she is selecting these messages over others is because the ads:
 - a. are different
 - b. are intense
 - c. appeal to her emotional states
 - d. appeal to her motives
 - e. are repetitious

5. Mark just met a new student named Jenny. He is trying to learn more about her through her social media sites. According to uncertainty reduction theory, which strategy is Mark using to reduce uncertainty?
 - a. passive
 - b. active
 - c. interactive
 - d. non-active
 - e. dismissive

References

- 1 Kahneman, D., Krueger, A. B., Schkade, D. A., Schwarz, N., & Stone, A. A. (2004). A survey method for characterizing daily life experience: The day reconstruction method. *Science*, 306(5702), 1776-1780. <https://doi.org/10.1126/science.1103572>
- 2 Kirchler, E. (1988). Diary reports on daily economic decisions of happy versus unhappy couples. *Journal of Economic Psychology*, 9(3), 327-357. [https://doi.org/10.1016/0167-4870\(88\)90039-6](https://doi.org/10.1016/0167-4870(88)90039-6)
- 3 Maslow, A. H. (1968). *Toward a psychology of being* (2nd ed.). Van Nostrand.
- 4 Wahba, M. A., & Bridwell, L. G. (1976). Maslow reconsidered: A review of research on the need hierarchy theory. *Organizational Behavior & Human Performance*, 15(2), 212-240. [https://doi.org/10.1016/0030-5073\(76\)90038-6](https://doi.org/10.1016/0030-5073(76)90038-6)
- 5 Hofstede, G. (1984). The cultural relativity of the quality of life concept. *The Academy of Management Review*, 9(3), 389-398. <https://doi.org/10.2307/258280>
- 6 Dailey, R. M. (2010). Testing components of confirmation: How acceptance and challenge from mothers, fathers, and siblings are related to adolescent self-concept. *Communication Monographs*, 77(4), 592-617. <https://doi.org/10.1080/03637751.2010.499366>
- 7 Lannoy, S., Chatard, A., Selimbegovic, L., Tello, N., Van der Linden, M., Heeren, A., & Billieux, J. (2020). Too good to be cautious: High implicit self-esteem predicts self-reported dangerous mobile phone use. *Computers in Human Behavior*, 103, 208-213. <https://doi.org/10.1016/j.chb.2019.09.018>
- 8 Restivo, S. (2020). The social self: Beyond the myth of individualism. In *Einstein's brain: Genius, culture, and social networks* (pp. 19-37). Springer International Publishing. https://doi.org/10.1007/978-3-030-32918-1_2
- 9 Berger, C.R. & Calabrese, R.J. (1975). Some explorations in initial interaction and beyond: Toward a developmental theory of interpersonal communication. *Human Communication Research*, 1(2), 99-112. <https://doi.org/10.1111/j.1468-2958.1975.tb00258.x>
- 10 Berger, C. R., & Calabrese, R. J. (1974). Some explorations in initial interaction and beyond: Toward a developmental theory of interpersonal communication. *Human Communication Research*, 1(2), 99-112. <https://doi.org/10.1111/j.1468-2958.1975.tb00258.x>
- 11 Rabin, M., & J. L. Schrag. (1999). First impressions matter: A model of confirmatory bias. *The Quarterly Journal of Economics*, 114(1), 37-82. <https://doi.org/10.1162/003355399555945>
- 12 Chang, H. H., Fang, P. W., & Huang, C. H. (2016). The impact of on-line consumer reviews on value perception: The dual-process theory and uncertainty reduction. In *Web design and development: Concepts, methodologies, tools, and applications* (pp. 1498-1524). IGI Global.
- 13 Byron, K., & Baldridge, D. C. (2007). E-mail recipients' impressions of senders' likability: The interactive effect of nonverbal cues and recipients' personality. *The Journal of Business Communication*, 44(2), 137-160. <https://doi.org/10.1177/0021943606297902>
- 14 The Associated Press. (2011). BC-FBN--Cowboys-Williams-Engagement Ring,2nd Ld-Writethru, FBN. In AP Regional State Report - Texas. *The Associated Press*.
- 15 O'Sullivan, P. B. (2000). What you don't know won't hurt me: Impression management functions of communication channels in relationships. *Human Communication Research*, 26(3), 403-431. <https://doi.org/10.1093/hcr/26.3.403>
- 16 Ameli, R. (2014). *Mindful listening to sounds*. In *25 lessons in mindfulness: Now time for healthy living*. (pp. 116-119). American Psychological Association.
- 17 Freeman, J. B., & Ambady, N. (2011). A dynamic interactive theory of person construal. *Psychological Review*, 118(2), 247-279. <https://doi.org/10.1037/a0022327>
- 18 Adler, R. B., Rosenfeld, L. B., Towne, N., & Scott, M. (1986). *Interplay: The process of interpersonal communication*. Holt, Rinehart, and Winston.
- 19 Diamond, L. M., & Hicks, A. M. (2012). "It's the economy, honey!" Couples' blame attributions during the 2007-2009 economic crisis. *Personal Relationships*, 19(3), 586-600. <https://doi.org/10.1111/j.1475-6811.2011.01380.x>

- 20 Model. (2020). *BusinessDictionary.com*. <http://www.businessdictionary.com/definition/model.html>
- 21 Weaver, W. & Shannon, C. E. (1963). *The mathematical theory of communication*. University of Illinois Press.
- 22 Schramm, W. (1954). How communication works. In *The process and effects of communication* (pp. 3-26). University of Illinois Press.
- 23 Berlo, D. (1960). *The process of communication: An introduction to theory and practice*. Holt, Reinhart, and Winston.
- 24 Mcquail, D. & Windhall, S. (2015). *Communication models for the study of mass communications*. Routledge.
- 25 Watzlawick, P., & Beavin, J. H., & Jackson, D. D. (1967). *Pragmatics of human communication: A study of interactional patterns, pathologies, and paradoxes*. Norton.
- 26 Barnlund, D. C. (1970). A transactional model of communication. In K. K. Sereno & C. D. Mortensen (Eds.), *Foundations of communications theory*. Harper & Row.
- 27 Wrench, J. S., Goding, A., Johnson, D., and Attias, B. (2011). *Stand up, speak out: The practice and ethics of public speaking*. Flat World Knowledge. Retrieved from: <http://bit.ly/FWK-Wrench>
- 28 Shapiro, S. L., & Carlson, L. E. (2017). *The art and science of mindfulness: Integrating mindfulness into psychology and the helping professions* (2nd ed.). American Psychological Association.
- 29 Tatkin, L. (2019). *Couples communication: How mindful communication habits can work miracles in your relationship and why you need to improve your communication skills right now*. Author.
- 30 Ibid, pg. 6.
- 31 Killingsworth, M. A., & Gilbert, D. T. (2010). A wandering mind is an unhappy mind. *Science*, 330(6006), 932. <https://doi.org/10.1126/science.1192439>
- 32 Thompson, N. (2015). *People skills*. Macmillan International Higher Education.
- 33 Hopkins, L. (2005). People skills: Eight essential people skills. *Ezine @rticles*. <http://EzineArticles.com/12294>
- 34 Colman, A. (2008). *A dictionary of psychology* (3 ed.). Oxford University Press.
- 35 National Communication Association. (2017). *Credo for ethical communication*. <https://tinyurl.com/snzsxzb>
- 36 Morreale, S. P., Valenzano, J. M., & Bauer, J. A. (2016). Why communication education is important: A third study on the centrality of the discipline. *Communication Education*, 66(4), 402-422. <https://doi.org/10.1080/03634523.2016.1265136>; pg. 412.
- 37 Hart, R. P., & Burks, D. M. (1972). Rhetorical sensitivity and social interaction. *Speech Monographs*, 39(2), 75-91. <https://doi.org/10.1080/03637757209375742>; pg. 76.

END OF CHAPTER QUIZ

ANSWER KEY

- 1) A 2) C 3) B 4) D 5) B



I am...

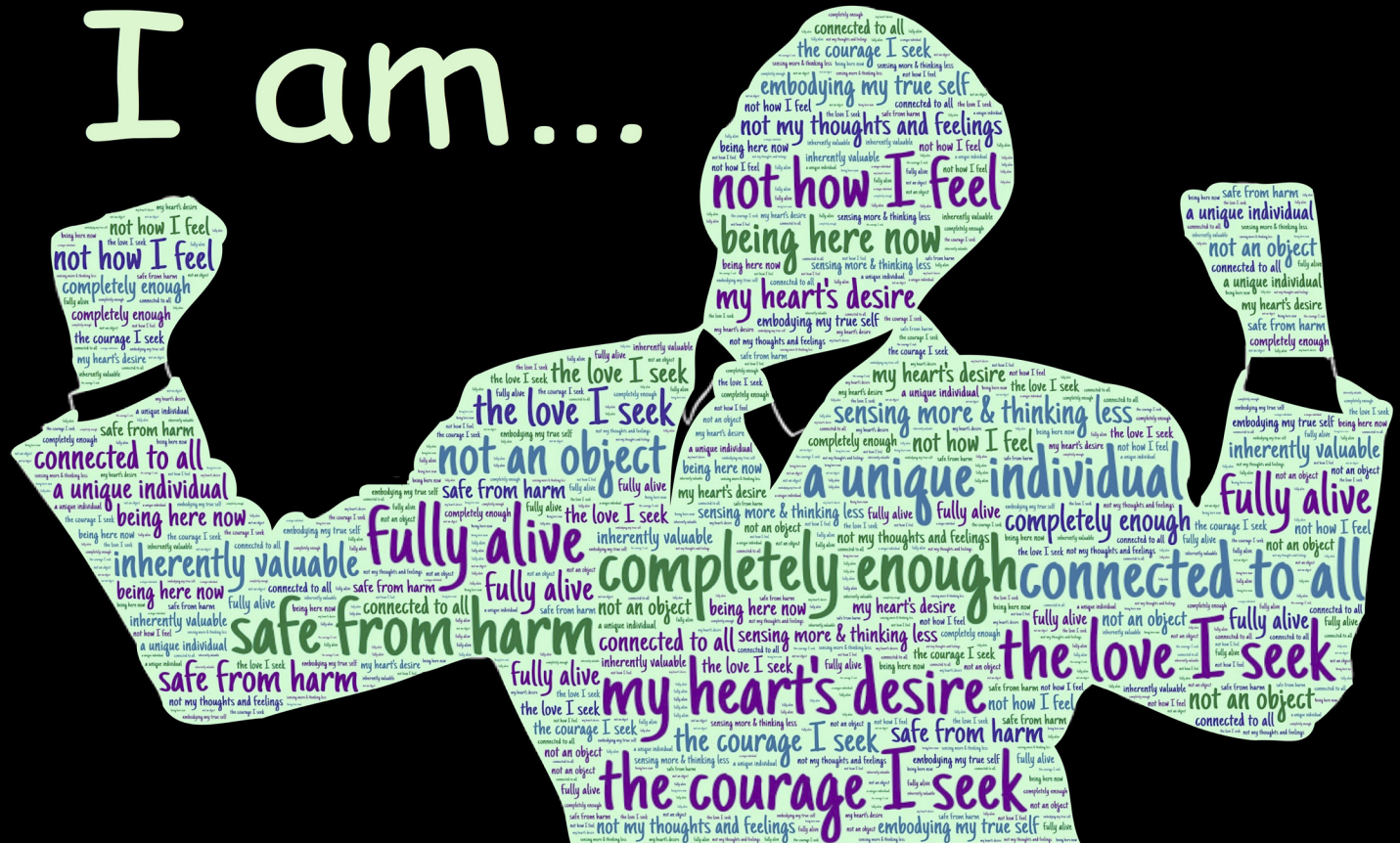

Image by [johnhain](#) from Pixabay

Chapter 3

Intrapersonal Communication

Who are you? Have you ever sat around thinking about how you fit into the larger universe. Manford Kuhn created a simple exercise to get at the heart of this question.¹ Take out a piece of paper and number 1 to 20 (or use the worksheet in the workbook). For each number, answer the question “Who Am I?” using a complete sentence. Results from this activity generally demonstrate five distinct categories about an individual: social group an individual belongs to, ideological beliefs, personal interests, personal ambitions, and self-evaluations. If you did the Twenty Item Test, take a second and identify your list using this scheme. All of these five categories are happening at what is called the intrapersonal-level.

Intrapersonal refers to something that exists or occurs within an individual’s self or mind. This chapter focuses on understanding intrapersonal processes and how they relate to communication.

Larry Barker and Gordon Wiseman created one of the oldest definitions of the term “intrapersonal communication” in the field of communication. Barker and Wiseman defined intrapersonal communication as “the creating, functioning, and evaluating of symbolic processes which operate

primarily within oneself.”² The researchers go on to explain that intrapersonal communication exists on a continuum from thinking and reflecting (more internal) to talking aloud or writing a note to one’s self (more external).

More recently, Samuel Riccillo defined intrapersonal communication as a “process involving the activity of the individual biological organism’s capacity to coordinate and organize complex actions of an intentional nature... For the human organism, such complex interactions are anchored in the signaling processes known as symbolic language.”³ Both the Barker and Wiseman and the Riccillo definitions represent two ends of the spectrum with regards to the idea of intrapersonal communication. For our purposes in this book, we define intrapersonal communication as something of a hybrid between these two definitions. **Intrapersonal communication** refers to communication phenomena that exist within or occurs because of an individual’s self or mind. Under this definition, we can examine Barker and Wiseman’s notions of both ends of their intrapersonal communication continuum while also realizing that Riccillo’s notions of biology (e.g., personality and communication traits) are equally important.

3.1 Who Are You?

LEARNING

OUTCOMES

1. Differentiate between self-concept and self-esteem.
2. Explain what is meant by Charles Horton Cooley’s concept of the looking-glass self.
3. Examine the impact that self-esteem has on communication.

In the first part of this chapter, we mentioned Manford Kuhn’s “Who Am I?” exercise for understanding ourselves. A lot of the items generally listed by individuals completing this exercise can fall into the areas of self-concept and self-esteem. In this section, we’re going to examine both of these concepts.

Self-Concept

According to Roy F. Baumeister (1999), **self-concept** implies “the individual’s belief about himself or herself, including the person’s attributes and who and what the self is.”⁴ An attribute is a characteristic, feature, or quality or inherent part of a person, group, or thing. In 1968, social psychologist Norman Anderson came up with a list of 555 personal attributes.⁵ He had research participants rate the 555 attributes from most desirable to least desirable. The top ten most desirable characteristics were:

1. Sincere
2. Honest
3. Understanding
4. Loyal
5. Truthful
6. Trustworthy
7. Intelligent
8. Dependable
9. Open-Minded

10. Thoughtful

Conversely, the top ten least desirable attributes were:

1. Liar
2. Phony
3. Mean
4. Cruel
5. Dishonest
6. Untruthful
7. Obnoxious
8. Malicious
9. Dishonorable
10. Deceitful

When looking at this list, do you agree with the ranks from 1968? In a more recent study, conducted by Jesse Chandler using an expanded list of 1,042 attributes,⁶ the following pattern emerged for the top 10 most positively viewed attributes:

1. Honest
2. Likable
3. Compassionate
4. Respectful
5. Kindly
6. Sincere
7. Trustworthy
8. Ethical
9. Good-Natured
10. Honorable

And here is the updated list for the top 10 most negatively viewed attributes:

1. Pedophilic
2. Homicidal
3. Evil-Doer
4. Abusive
5. Evil-Minded
6. Nazi
7. Mugger
8. Asswipe
9. Untrustworthy
10. Hitlerish

Some of the changes in both lists represent changing times and the addition of the new terms by Chandler. For example, the terms sincere, honest, and trustworthy were just essential attributes for both the 1968 and 2018 studies. Conversely, none of the negative attributes remained the same from 1968 to 2018. The negative attributes, for the most part, represent more modern sensibilities about personal attributes.

The Three Selves

Carl Rogers, a distinguished psychologist in the humanistic approach to psychology, believed that an

individual's self-concept is made of three distinct things: self-image, self-worth, and ideal-self.⁷

Self-Image

An individual's **self-image** is a view that they have of themselves. If we go back and look at the attributes that we've listed in this section, think about these as laundry lists of possibilities that impact your view of yourself. For example, you may view yourself as ethical, trustworthy, honest, and loyal, but you may also realize that there are times when you are also obnoxious and mean. For a positive self-image, we will have more positive attributes than negative ones. However, it's also possible that one negative attribute may overshadow the positive attributes, which is why we also need to be aware of our perceptions of our self-worth.

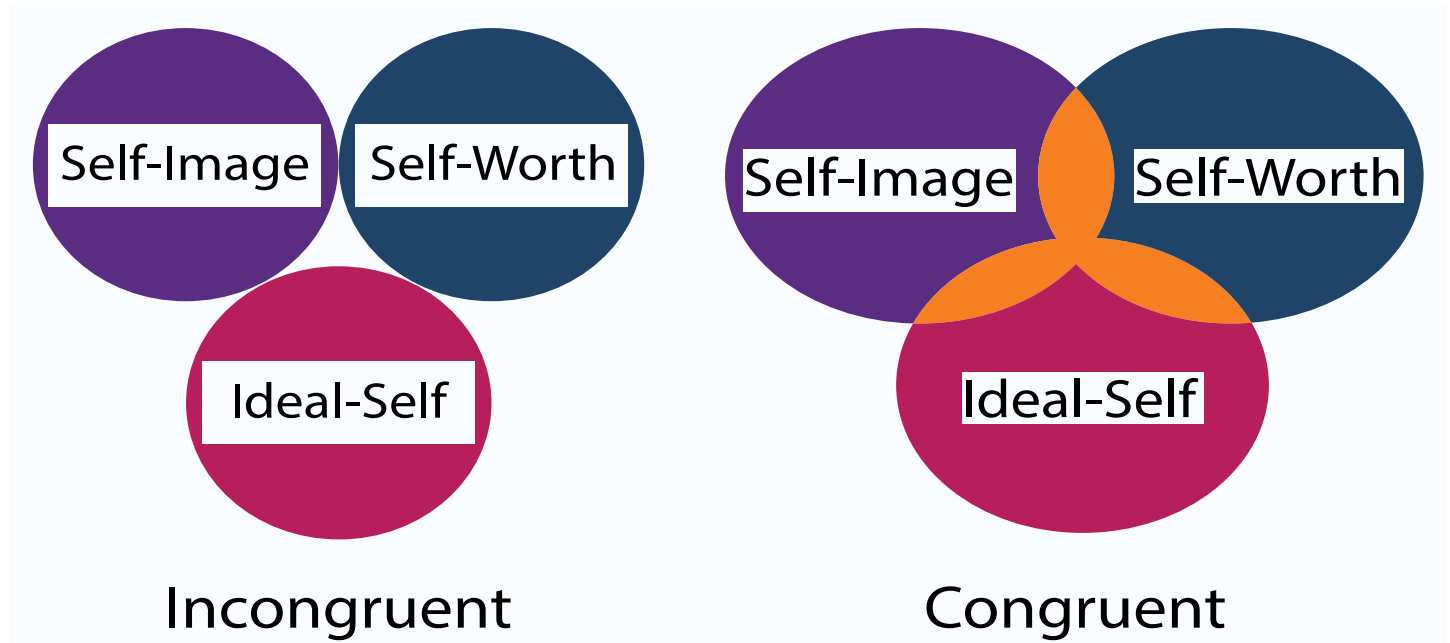

Figure 3.1 Carl Rogers' Self-Concept

Self-Worth

Self-worth is the value that you place on yourself. In essence, self-worth is the degree to which you see yourself as a good person who deserves to be valued and respected. Unfortunately, many people judge their self-worth based on arbitrary measuring sticks like physical appearance, net worth, social circle/ clique, career, grades, achievements, age, relationship status, likes on Facebook, social media followers, etc.... Interested in seeing how you view your self-worth? Then take a minute and complete the Contingencies of Self-Worth Scale.⁸ According to Courtney Ackerman, there are four things you can do to help improve your self-worth:⁹

1. You no longer need to please other people.
2. No matter what people do or say, and regardless of what happens outside of you, you alone control how you feel about yourself.
3. You have the power to respond to events and circumstances based on your internal sources, resources, and resourcefulness, which are the reflection of your true value.
4. Your value comes from inside, from an internal measure that you've set for yourself.

Ideal-Self

The final characteristic of Rogers' three parts to self-concept is the ideal-self.¹⁰ The **ideal-self** is the version of yourself that you would like to be, which is created through our life experiences, cultural demands, and expectations of others. The real-self, on the other hand, is the person you are. The ideal-self is perfect, flawless, and, ultimately, completely unrealistic. When an individual's real-self and ideal-self are not remotely similar, someone needs to think through if that idealized version of one's self is attainable. It's also important to know that our ideal-self is continuously evolving. How many of us wanted to be firefighters, police officers, or astronauts as kids? Some of you may still want to be one of these, but most of us had our ideal-self evolve.

Three Self's Working Together

Now that we've looked at the three parts of Carl Rogers' theory of self-concept, let's discuss how they all work together to create one's self-concept. Rogers' theory of self-concept also looks at a concept we discussed in Chapter 2 when we discussed Abraham Maslow's Hierarchy of Needs. Specifically, the idea of self-actualization. In Rogers' view, self-actualization cannot happen when an individual's self-image, self-worth, and ideal-self have no overlap.

As you can see in Figure 3.1, on the left side, you have the three parts of self-concept as very distinct in this individual, which is why it's called incongruent, or the three are not compatible with each other. In this case, someone's self-image and ideal-self may have nothing in common, and this person views themselves as having no self-worth. When someone has this type of incongruence, they are likely to exhibit other psychological problems. On the other hand, when someone's self-image, ideal-self, and self-worth overlap, that person is considered congruent because the three parts of self-concept overlap and are compatible with each other. The more this overlap grows, the greater the likelihood someone will be able to self-actualize. Rogers believed that self-actualization was an important part of self-concept because until a person self-actualizes, then he/she/they will be out of balance with how he/she/they relate to the world and with others.

In 1902, Charles Horton Cooley wrote *Human Nature and the Social Order*. In this book, Cooley introduced a concept called the looking-glass self: "Each to each a looking-glass / Reflects the other that doth pass"¹¹ Although the term "looking-glass" isn't used very often in today's modern tongue, it means a mirror. Cooley argues, when we are looking to a mirror, we also think about how others view us and the judgments they make about us. Cooley ultimately posed three postulates:

1. Actors learn about themselves in every situation by exercising their imagination to reflect on their social performance.
2. Actors next imagine what those others must think of them. In other words, actors imagine the others' evaluations of the actor's performance.
3. The actor experiences an affective reaction to the imagined evaluation of the other.¹²

In Figure 3.2, we see an illustration of this basic idea. You have a figure standing before four glass panes. In the left-most mirror, the figure has devil horns; in the second, a pasted on a fake smile; in the third, a tie; and in the last one, a halo. Maybe the figure's ex sees the devil, his friends and family think the figure is always happy, the figure's coworkers see a professional, and the figure's parents/guardians see their little angel. Along with each of these ideas, there are inherent judgments. And, not all of these judgments are necessarily accurate, but we still come to understand and know ourselves based on our perceptions of these judgments.

Ultimately, our self-image is shaped through our interactions with others, but only through the mediation of our minds. At the same time, because we perceive that others are judging us, we also tend to shape our façade to go along with that perception. For example, if you work in the customer service

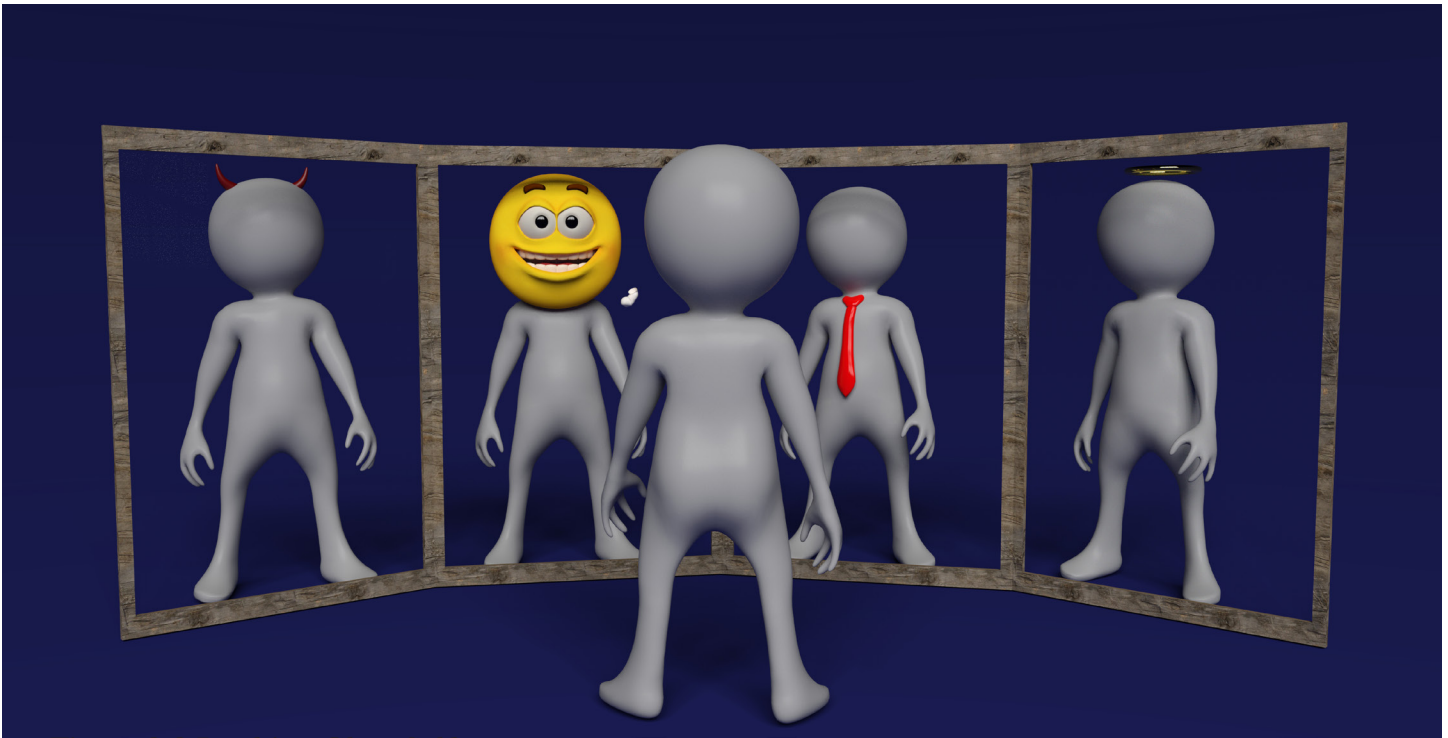

Figure 3.2 Looking-Glass Self

industry, you may sense that you are always expected to smile. Since you want to be viewed positively, you plaster on a fake smile all the time no matter what is going on in your personal life. At the same time, others may start to view you as a happy-go-lucky person because you're always in a good mood.

Thankfully, we're not doing this all the time, or we would be driving ourselves crazy. Instead, there are certain people in our lives about whose judgments we worry more than others. Imagine you are working in a new job. You respect your new boss, and you want to gain her/his/their respect in return. Currently, you believe that your boss doesn't think you're a good fit for the organization because you are not serious enough about your job. If you perceive that your boss will like you more if you are a more serious worker, then you will alter your behavior to be more in line with what your boss sees as "serious." In this situation, your boss didn't come out and say that you were not a serious worker, but we perceived the boss' perception of us and her/his/their judgment of that perception of us and altered our behavior to be seen in a better light.

Self-Esteem

One of the most commonly discussed intrapersonal communication ideas is an individual's self-esteem. There are a ton of books in both academic and non-academic circles that address this idea.

Defining Self-Esteem

Self-esteem is an individual's subjective evaluation of her/his/their abilities and limitations. Let's break down this definition into sizeable chunks.

Subjective Evaluation

The definition states that someone's self-esteem is an "individual's subjective evaluation." The word "subjective" emphasizes that self-esteem is based on an individual's emotions and opinions and is not

based on facts. For example, many people suffer from what is called the impostor syndrome, or they doubt their accomplishments, knowledge, and skills, so they live in fear of being found out a fraud. These individuals have a constant fear that people will figure out that they are “not who they say they are.” Research in this area generally shows that these fears of “being found out” are not based on any kind of fact or evidence. Instead, these individuals’ emotions and opinions of themselves are fueled by incongruent self-concepts. Types of people who suffer from impostor syndrome include physicians, CEOs, academics, celebrities, artists, and pretty much any other category. Again, it’s important to remember that these perceptions are subjective and not based on any objective sense of reality. Imagine a physician who has gone through four years of college, three years of medical school, three years of residency, and another four years of specialization training only to worry that someone will find out that he/she/they aren’t that smart after all. There’s no objective basis for this perception; it’s completely subjective and flies in the face of facts.

In addition to the word “subjective,” we also use the word “evaluation” in the definition of self-esteem. By evaluation, we mean a determination or judgment about the quality, importance, or value of something. We evaluate a ton of different things daily:

1. We evaluate how we interact with others.
2. We evaluate the work we complete.
3. We also evaluate ourselves and our specific abilities and limitations.

Our lives are filled with constant evaluations.

Abilities

When we discuss our abilities, we are referring to the acquired or natural capacity for specific talents, skills, or proficiencies that facilitate achievement or accomplishment. First, someone’s abilities can be inherent (natural) or they can be learned (acquired). For example, if someone is 6’6”, has excellent reflexes, and has a good sense of space, he/she/they may find that they have a natural ability to play basketball that someone who is 4’6”, has poor reflex speed, and has no sense of space simply does not have. That’s not to say that both people cannot play basketball, but they will both have different ability levels. They can both play basketball because they can learn skills necessary to play basketball: shooting the ball, dribbling, rules of the game, etc. In a case like basketball, professional-level players need to have a combination of both natural and acquired abilities.

We generally break abilities into two different categories: talent or skills to help distinguish what we are discussing. First, talent is usually more of an inherent or natural capacity. For example, someone may look like the ideal basketball player physically, but the person may simply have zero talent for the game. Sometimes we call talent the “it factor” because it’s often hard to pinpoint why someone people have it and others don’t. Second, skills refer to an individual’s use of knowledge or physical being to accomplish a specific task. We often think of skills in terms of the things we learn to do. For example, most people can learn to swim or ride a bike. Doing this may take some time to learn, but we can develop the skills necessary to stay afloat and move in the water or the skills necessary to achieve balance and pedal the bike.

The final part of the definition of abilities is the importance of achievement and accomplishment. Just because someone has learned the skills to do something does not mean that they can accomplish the task. Think back to when you first learned to ride a bicycle (or another task). Most of us had to try and try again before we found ourselves pedaling on our own without falling over. The first time you got on the bicycle and fell over, you didn’t have the *ability* to ride a bike. You may have had a general understanding of how it worked, but there’s often a massive chasm between knowing how something

is done and then actually achieving or accomplishing it. As such, when we talk about abilities, we really emphasize the importance of successful completion.

Limitations

In addition to one's abilities, it's always important to recognize that we all have limitations. In the words of my podiatrist, I will never be a runner because of the shape of my arch. Whether I like it or not, my foot's physical structure will not allow me to be an effective runner. Thankfully, this was never something I wanted to be. I didn't sit up all night as a child dreaming of running a marathon one day. In this case, I have a natural limitation, but it doesn't negatively affect me because I didn't evaluate running positively for myself. On the flip side, growing up, I took years of piano lessons, but honestly, I was just never that good at it. I have short, stubby fingers, so reaching notes on a piano that are far away is just hard for me. To this day, I wish I was a good piano player. I am disappointed that I couldn't be a better piano player. Now, does this limitation cripple me? No.

We all have limitations on what we can and cannot do. When it comes to your self-esteem, it's about how you evaluate those limitations. Do you realize your limitations and they don't bother you? Or do your limitations prevent you from being happy with yourself? When it comes to understanding limitations, it's important to recognize the limitations that we can change and the limitations we cannot change. One problem that many people have when it comes to limitations is that they cannot differentiate between the types of limitations. If I had wanted to be a runner growing up and then suddenly found out that my dream wasn't possible because of my feet, then I could go through the rest of my life disappointed and depressed that I'm not a runner. Even worse, I could try to force myself to be a runner and cause long-term damage to my body.

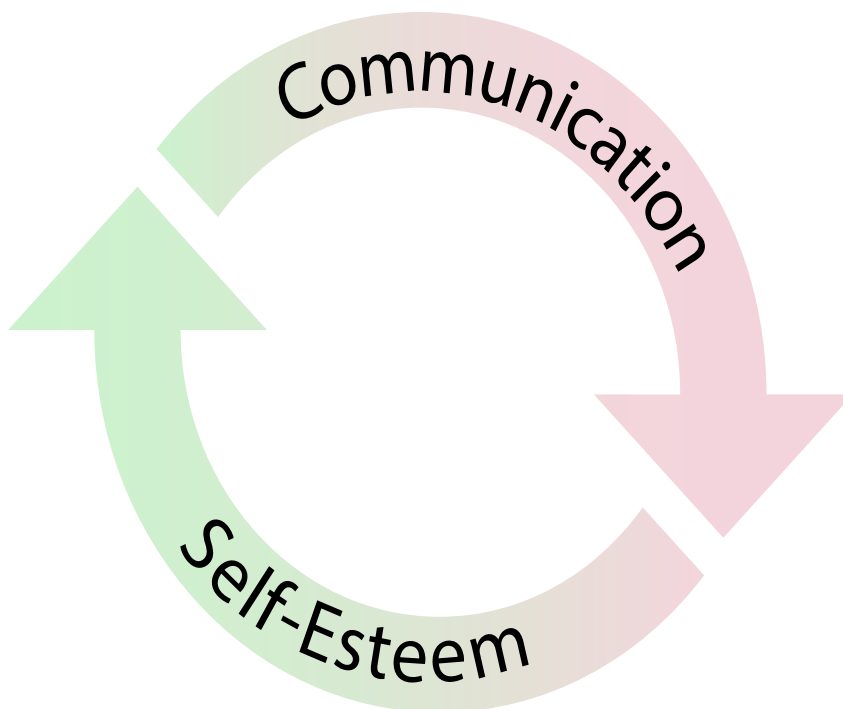

Figure 3.3 Self-Esteem and Communication

Self-Esteem and Communication

You may be wondering by this point about the importance of self-esteem in interpersonal communication. Self-esteem and communication have a reciprocal relationship (as depicted in Figure 3.3). Our communication with others impacts our self-esteem, and our self-esteem impacts our communication with others. As such, our self-esteem and communication are constantly being transformed by each other.

As such, interpersonal communication and self-esteem cannot be separated. Now, our interpersonal communication is not the only factor

that impacts self-esteem, but interpersonal interactions are one of the most important tools we have in developing our selves.

MINDFULNESS ACTIVITY



One of the beautiful things about mindfulness is that it positively impacts someone's self-esteem.¹³ It's possible that people who are higher in mindfulness report higher self-esteem because of the central tenant of non-judgment. People with lower self-esteems often report highly negative views of themselves and their past experiences in life. These negative judgments can start to wear someone down.

Christopher Pepping, Analise O'Donovan, and Penelope J. Davis believe that mindfulness practice can help improve one's self-esteem for four reasons:¹⁴

- Labeling internal experiences with words, which might prevent people from getting consumed by self-critical thoughts and emotions;
- Bringing a non-judgmental attitude toward thoughts and emotions, which could help individuals have a neutral, accepting attitude toward the self;
- Sustaining attention on the present moment, which could help people avoid becoming caught up in self-critical thoughts that relate to events from the past or future;
- Letting thoughts and emotions enter and leave awareness without reacting to them.¹⁵

For this exercise, think about a recent situation where you engaged in self-critical thoughts.

1. What types of phrases ran through your head? Would you have said these to a friend? If not, why do you say them to yourself?
1. What does the negative voice in your head sound like? Is this voice someone you want to listen to? Why?
2. Did you try temporarily distracting yourself to see if the critical thoughts would go away (e.g., mindfulness meditation, coloring, exercise)? If yes, how did that help? If not, why?
3. Did you examine the evidence? What proof did you have that the self-critical thought was true?
4. Was this a case of a desire to improve yourself or a case of non-compassion towards yourself?

Self-Compassion

Some researchers have argued that self-esteem as the primary measure of someone's psychological health may not be wise because it stems from comparisons with others and judgments. As such, Kristy Neff has argued for the use of the term self-compassion.¹⁶

Self-Compassion stems out of the larger discussion of compassion. Compassion "involves being touched by the suffering of others, opening one's awareness to others' pain and not avoiding or disconnecting from it, so that feelings of kindness toward others and the desire to alleviate their suffering emerge."¹⁷ **Compassion** then is about the sympathetic consciousness for someone who is suffering or unfortunate. **Self-compassion** "involves being touched by and open to one's own suffering, not avoiding or disconnecting from it, generating the desire to alleviate one's suffering and to heal oneself with kindness. Self-compassion also involves offering nonjudgmental understanding to one's pain, inadequacies and failures, so that one's experience is seen as part of the larger human experience."¹⁸ Neff argues that self-compassion can be broken down into three distinct categories: self-kindness, common humanity, and mindfulness (Figure 3.4).



Figure 3.4 Three Factors of Self-Compassion

Self-Kindness

Humans have a really bad habit of beating ourselves up. As the saying goes, we are often our own worst enemies. Self-kindness is simply extending the same level of care and understanding to ourselves as we would to others. Instead of being harsh and judgmental, we are encouraging and supportive. Instead of being critical, we are empathic towards ourselves. Now, this doesn't mean that we just ignore our faults and become narcissistic (excessive interest in oneself), but rather we realistically evaluate ourselves as we discussed in the Mindfulness Exercise earlier.

Common Humanity

The second factor of self-compassion is common humanity, or “seeing one’s

experiences as part of the larger human experience rather than seeing them as separating and isolating.”¹⁹ As Kristen Naff and Christopher Germer realize, we’re all flawed works in progress.²⁰ No one is perfect. No one is ever going to be perfect. We all make mistakes (some big, some small). We’re also all going to experience pain and suffering in our lives. Being self-compassionate is approaching this pain and suffering and seeing it for what it is, a natural part of being human. “The pain I feel in difficult times is the same pain you feel in difficult times. The circumstances are different, the degree of pain is different, but the basic experience of human suffering is the same.”²¹

Mindfulness

The final factor of self-compassion is mindfulness. Although Naff defines mindfulness in the same terms we’ve been discussing in this text, she specifically addresses mindfulness as a factor of pain, so she defines mindfulness, with regards to self-compassion, as “holding one’s painful thoughts and feelings in balanced awareness rather than over-identifying with them.”²² Essentially, Naff argues that mindfulness is an essential part of self-compassion, because we need to be able to recognize and acknowledge when we’re suffering so we can respond with compassion to ourselves.

Don’t Feed the Vulture

One area that we know can hurt someone’s self-esteem is what Sidney Simon calls “vulture statements.”

According to Simon,

Vulture (‘vul-cher) noun. 1: any of various large birds of prey that are related to the hawks, eagles and falcons, but with the head usually naked of feathers and that subsist chiefly or entirely on dead flesh.²³

Unfortunately, all of us have vultures circling our heads or just sitting on our shoulders. In Figure 3.5, we see a young woman feeding an apple to her vulture. This apple represents all of the negative things we say about ourselves during a day. Many of us spend our entire days just feeding our vultures and feeding our vultures these self-deprecating, negative thoughts and statements. Admittedly, these negative thoughts “come from only one place. They grow out of other people’s criticisms, from the negative responses to what we do and say, and the way we act.”²⁴ We have the choice to either let these thoughts consume us or fight them. According to Virginia Richmond, Jason Wrench, and Joan Gorham, the following are characteristic statements that vultures wait to hear so they can feed (see also Figure 3.6):



Figure 3.5 Don’t Feed the Vulture

- Oh boy, do I look awful today; I look like I’ve been up all night.
- Oh, this is going to be an awful day.
- I’ve already messed up. I left my students’ graded exams at home.
- Boy, I should never have gotten out of bed this morning.
- Gee whiz. I did an awful job of teaching that unit.
- Why can’t I do certain things as well as Mr. Smith next door?
- Why am I always so dumb?
- I can’t believe I’m a teacher; why, I have the mentality of a worm.
- I don’t know why I ever thought I could teach.
- I can’t get anything right.
- Good grief, what am I doing here? Why didn’t I select any easy job?
- I am going nowhere, doing nothing; I am a failure at teaching.
- In fact, I am a failure in most things I attempt.²⁵

Do any of these vulture statements sound familiar to you? If you’re like us, I’m sure they do. Part of



Figure 3.6 Don't Feed the Vulture

self-compassion is learning to recognize these vulture statements when they appear in our minds and evaluate them critically. Ben Martin proposes four ways to challenging vulture statements (negative self-talk):

1. Reality testing
 - What is my evidence for and against my thinking?
 - Are my thoughts factual, or are they just my interpretations?
 - Am I jumping to negative conclusions?
 - How can I find out if my thoughts are actually true?

2. Look for alternative explanations

- Are there any other ways that I could look at this situation?
- What else could this mean?
- If I were being positive, how would I perceive this situation?

3. Putting it in perspective

- Is this situation as bad as I am making out to be?
- What is the worst thing that could happen? How likely is it?
- What is the best thing that could happen?
- What is most likely to happen?
- Is there anything good about this situation?
- Will this matter in five years?

4. Using goal-directed thinking

- Is thinking this way helping me to feel good or to achieve my goals?
- What can I do that will help me solve the problem?
- Is there something I can learn from this situation, to help me do it better next time?²⁶

So, next time those vultures start circling you, check that negative self-talk. When we can stop these patterns of negativity towards ourselves and practice self-compassion, we can start plucking the feathers of those vultures. The more we treat ourselves with self-compassion and work against those vulture statements, the smaller and smaller those vultures get. Our vultures may never die, but we can make them much, much smaller.

Research Spotlight



In 2018, Laura Umphrey and John Sherblom examined the relationship between social communication competence, self-compassion, and hope. The goal of the study was to see if someone’s social communication competence could predict their ability to engage in self-compassion. Ultimately, the researchers found individuals who engaged in socially competent communication behaviors were more likely to engage in self-compassion, which “suggests that a person who can learn to speak with others competently, initiate conversations, engage others in social interaction, and be more outgoing, while managing verbal behavior and social roles, may also experience greater personal self-compassion” (p. 29).

Umphrey, L. R., & Sherblom, J. C. (2018). The constitutive relationship of social communication competence to self-compassion and hope. *Communication Research Reports*, 35(1), 22–32. <https://doi.org/10.1080/08824096.2017.1361395>

Key Takeaways

- Self-concept is an individual’s belief about themselves, including the person’s attributes and who and what the self is. Conversely, self-esteem is an individual’s subjective evaluation of their abilities and limitations.
- Sociologist Charles Horton Cooley coined the term “looking-glass self” to refer to the idea that an individual’s self-concept is a reflection of how an individual imagines how he or she appears to other people. In other words, humans are constantly comparing themselves to how they believe others view them.
- There is an interrelationship between an individual’s self-esteem and her/his/their communication. In essence, an individual’s self-esteem impacts how they communicate with others, and this communication with others impacts their self-esteem.

Exercises

- Pull out a piece of paper and conduct the “Who Am I?” exercise created by Manford Kuhn. Once you have completed the exercise, categorize your list using

Kuhn’s five distinct categories about an individual: social group an individual belongs to, ideological beliefs, personal interests, personal ambitions, and self-evaluations. After categorizing your list, ask yourself what your list says about your self-concept, self-image, self-esteem, and self-respect.

- Complete the Rosenberg Self-Esteem Scale (<http://www.wwnorton.com/college/psych/psychsci/media/rosenberg.htm>). After getting your results, do you agree with your results? Why or why not? Why do you think you scored the way you did on the measure?

3.2 Personality and Perception in Intrapersonal Communication

LEARNING OUTCOMES

1. Define and differentiate between the terms personality and temperament.
2. Explain common temperament types seen in both research and pop culture.
3. Categorize personality traits as either cognitive dispositions or personal-social dispositions.

After the previous discussions of self-concept, self-image, and self-esteem, it should be obvious that the statements and judgments of others and your view of yourself can affect your communication with others. Additional factors, such as your personality and perception, affect communication as well. Let us next examine these factors and the influence each has on communication.

Personality

Personality is defined as the combination of traits or qualities—such as behavior, emotional stability, and mental attributes—that make a person unique. Before going further, let’s quickly examine some of the research related to personality. John Daly categorizes personality into four general categories: cognitive dispositions, personal-social dispositions, communicative dispositions, and relational dispositions.²⁷ Before we delve into these four categories of personality, let’s take a quick look at two common themes in this area of research: nature or nurture and temperament.

Nature or Nurture

One of the oldest debates in the area of personality research is whether a specific behavior or thought process occurs within an individual because of their nature (genetics) or nurture (how he/she/they were raised). The first person to start investigating this phenomenon was Sir Francis Galton back in the 1870s.²⁸ In 1875, Galton sought out twins and their families to learn more about similarities and differences. As a whole, Galton found that there were more similarities than differences: “There is no escape from the conclusion that nature prevails enormously over nurture when the differences of nurture do not exceed what is commonly to be found among persons of the same rank of society and in the same country.”²⁹ However, the reality is that Galton’s twin participants had been raised together, so parsing out nature and nurture (despite Galton’s attempts) wasn’t completely possible. Although Galton’s anecdotes

provided some interesting stories, that's all they amounted to.

Minnesota Twins Raised Apart

So, how does one determine if something ultimately nature or nurture? The next breakthrough in this line of research started in the late 1970s when Thomas J. Bouchard and his colleagues at Minnesota State University began studying twins who were raised separately.³⁰ This research started when a pair of twins, Jim Lewis and Jim Springer, were featured in an article on February 19, 1979, in the *Lima News* in Lima, Ohio.³¹ Jim and Jim were placed in an adoption agency and separated from each other at four weeks of age. They grew up just 40 miles away from each other, but they never knew the other one existed. Jess and Sarah Springer and Ernest and Lucille Lewis were looking to adopt, and both sets of parents were told that their Jim had been a twin, but they were also told that his twin had died. Many adoption agencies believed that placing twins with couples was difficult, so this practice of separating twins at birth was an inside practice that the adoptive parents knew nothing about. Jim Lewis' mother had found out that Jim's twin was still alive when he was toddler, so Jim Lewis knew that he had a twin but didn't seek him out until he was 39 years old. Jim Springer, on the other hand, learned that he had been a twin when he was eight years old, but he believed the original narrative that his twin had died.

As you can imagine, Jim Springer was pretty shocked when he received a telephone message with his twin's contact information out of nowhere one day. The February 19th article in the *Lima News* was initially supposed to be a profile piece on one of the Springers' brothers, but the reporter covering the wedding found Lewis and Springer's tale fascinating. The reporter found several striking similarities between the twins:³²

- Their favorite subject in school was math
- Both hated spelling in school
- Their favorite vacation spot was Pas Grille Beach in Florida
- Both had previously been in law enforcement
- They both enjoyed carpentry as a hobby
- Both were married to women named Betty
- Both were divorced from women named Linda
- Both had a dog named "Toy"
- Both started suffering from tension headaches when they were 18
- Even their sons' names were oddly similar (James Alan and James Allan)

This sensationalist story caught the attention of Bouchard because this opportunity allowed him and his colleagues to study the influence rearing had on twins in a way that wasn't possible when studying twins who were raised together.

Over the next decade, Bouchard and his team of researchers would seek out and interview over 100 different pairs of twins or sets of triplets who had been raised apart.³³ The researchers were able to compare those twins to twins who were reared together. As a whole, they found more similarities between the two twin groups than they found differences. This set of studies is one of many that have been conducted using twins over the years to help us understand the interrelationship between rearing and genetics.

Twin Research in Communication

In the field of communication, the first major twin study published was conducted by Cary Wecht Horvath in 1995.³⁴ In her study, Horvath compared 62 pairs of identical twins and 42 pairs of fraternal

twins to see if they differed in terms of their communicator style, or “the way one verbally, nonverbally, and paraverbally interacts to signal how literal meaning should be taken, filtered, or understood.”³⁵ Ultimately, Horvath found that identical twins’ communicator styles were more similar than those of fraternal twins. Hence, a good proportion of someone’s communicator style appears to be a result of someone’s genetic makeup. However, this is not to say that genetics was the only factor at play about someone’s communicator style.

Other research in the field of communication has examined how a range of different communication variables are associated with genetics when analyzed through twin studies:^{36,37, 38}

- Interpersonal Affiliation
- Aggressiveness
- Social Anxiety
- Audience Anxiety
- Self-Perceived Communication Competence
- Willingness to Communicate
- Communicator Adaptability

It’s important to realize that the authors of this book do not assume nor promote that all of our communication is biological. Still, we also cannot dismiss the importance that genetics plays in our communicative behavior and development. Here is our view of the interrelationship among environment and genetics. Imagine we have two twins that were separated at birth. One twin is put into a middle-class family where she will be exposed to a lot of opportunities. The other twin, on the other hand, was placed with a lower-income family where the opportunities she will have in life are more limited. The first twin goes to a school that has lots of money and award-winning teachers. The second twin goes to an inner-city school where there aren’t enough textbooks for the students, and the school has problems recruiting and retaining qualified teachers. The first student has the opportunity to engage in a wide range of extracurricular activities both in school (mock UN, debate, student council, etc.) and out of school (traveling softball club, skiing, yoga, etc.). The second twin’s school doesn’t have the budget for extracurricular activities, and her family cannot afford out of school activities, so she ends up taking a job when she’s a teenager. Now imagine that these twins are naturally aggressive. The first twin’s aggressiveness may be exhibited by her need to win in both mock UN and debate; she may also strive to not only sit on the student council but be its president. In this respect, she demonstrates more prosocial forms of aggression. The second twin, on the other hand, doesn’t have these more prosocial outlets for her aggression. As such, her aggression may be demonstrated through more interpersonal problems with her family, teachers, friends, etc.... Instead of having those more positive outlets for her aggression, she may become more physically aggressive in her day-to-day life. In other words, we do believe that the context and the world where a child is reared is very important to how they display communicative behaviors, even if those communicative behaviors have biological underpinnings.

Temperament Types

Temperament is the genetic predisposition that causes an individual to behave, react, and think in a specific manner. The notion that people have fundamentally different temperaments dates back to the Greek physician Hippocrates, known today as the father of medicine, who first wrote of four temperaments in 370 BCE: Sanguine, Choleric, Phlegmatic, and Melancholic. Although closely related, temperament and personality refer to two different constructs. Jan Strelau explains that temperament and personality differ in five specific ways:

1. Temperament is biologically determined where personality is a product of the social environment.
2. Temperamental features may be identified from early childhood, whereas personality is shaped in later periods of development.
3. Individual differences in temperamental traits like anxiety, extraversion-introversion, and stimulus-seeking are also observed in animals, whereas personality is the prerogative of humans.
4. Temperament stands for stylistic aspects. Personality for the content aspect of behavior.
5. Unlike temperament, personality refers to the integrative function of human behavior.³⁹

In 1978, David Keirsey developed the Keirsey Temperament Sorter, a questionnaire that combines the Myers-Briggs Temperament Indicator with a model of four temperament types developed by psychiatrist Ernst Kretschmer in the early 20th century.⁴⁰ Take a minute and go to David Keirsey's website and complete his four-personality type questionnaire (<http://www.keirsey.com/sorter/register.aspx>). You'll also be able to learn a lot more about the four-type personality system.

In reality, there are a ton of four-type personality system systems that have been created over the years. Table 3.1 provides just a number of the different four-type personality system that are available on the market today. Each one has its quirks and patterns, but the basic results are generally the same.

Hippocrates Greek Terms	Sanguine	Melancholy	Choleric	Phlegmatic
Wired that Way	Popular Sanguine	Perfect Melancholy	Powerful Choleric	Peaceful Phlegmatic
Keirsey Temperament (1967)	Artisan Sensation Seeking	Rational Knowledge Seeking	Guardian Security Seeking	Idealist Identity Seeking
Carl Jung's Theory (1921)	Feeling	Thinking	Sensing	Intuition
Myers-Briggs Type Indicator (1962)	Feeler Extravert	Thinker Introvert	Intuitor Extravert	Sensor Introvert
"What's My Style?" (WMS)	Spirited	Systematic	Direct	Considerate
The P's	Popular	Perfect	Powerful	Peaceful
The S's	Spirited	Systematic	Self-propelled	Solid
The A's	Active	Analytical	Administrative	Amiable
LEAD Test	Expressor	Analyst	Leader	Dependable
Biblical Characters	Peter	Moses	Paul	Abraham
DiSC	Influencing of Others	Cautiousness/Compliance	Dominance	Steadiness
McCarthy/4MAT System	Dynamic	Analytic	Common Sense	Innovative
Plato (340 BC)	Artisan	Scientist	Guardian	Philosopher
Enneagram	Helper Romantic	Asserter Perfectionist	Adventurer Achiever	Peacemaker Observer
True Colors	Orange	Gold	Green	Blue

Children’s Literature	Tigger	Eeyore	Rabbit	Pooh
Charlie Brown Characters	Snoopy	Linus	Lucy	Charlie Brown
<i>Who Moved My Cheese?</i>	Scurry	Hem	Sniff	Haw
LEAD Test	Expresser	Analyst	Leader	Dependable
Eysenck’s EPQ-R	High Extravert Low Neurotic	Low Extravert High Neurotic	High Extravert High Neurotic	Low Extravert Low Neurotic

Table 3.1. Comparing 4-Personality Types

And before you ask, none of the research examining the four types has found clear sex differences among the patterns. Females and males are seen proportionately in all four categories.

For example, training publisher HRDQ publishes the “What’s My Style?” series (<http://www.hrdqstore.com/Style>), and has applied the four-personalities to the following workplace issues: coaching, communication, leadership, learning, selling, teams, and time management.

David Keirse argues that the consistent use of the four temperament types (whatever terms we use) is an indication of the long-standing tradition and complexity of these ideas.⁴¹

The Big Five

In the world of personality, one of the most commonly discussed concepts in research is the Big Five. In the late 1950s, Ernest C. Tupes and Raymond E. Christal conducted a series of studies examining a model of personality.^{42,43} Ultimately, they found five consistent personality clusters they labeled: surgency, agreeableness, dependability, emotional stability, and culture). Listed below are the five broad personality categories with the personality trait words in parentheses that were associated with these categories:

1. Surgency (silent vs. talkative; secretive vs. frank; cautious vs. adventurous; submissive vs. assertive; and languid, slow vs. energetic)
2. Agreeableness (spiteful vs. good-natured; obstructive vs. cooperative; suspicious vs. trustful; rigid vs. adaptable; cool, aloof vs. attentive to people; jealous vs. not so; demanding vs. emotionally mature; self-willed vs. mild; and hard, stern vs. kindly)
3. Dependability (frivolous vs. responsible and unscrupulous vs. conscientious; indolent vs. insistently orderly; quitting vs. persevering; and unconventional vs. conventional)
4. Emotional Stability (worrying, anxious vs. placid; easily upset vs. poised, tough; changeable vs. emotionally stable; neurotic vs. not so; hypochondriacal vs. not so; and emotional vs. calm)
5. Culture (boorish vs. intellectual, cultured; clumsy, awkward vs. polished; immature vs. independent-minded; lacking artistic feelings vs. esthetically fastidious, practical, logical vs. imaginative)

Although Tupes and Christal were first, they were not the only psychologists researching the idea of personality clusters.

Two other researchers, Robert R. McCrae and Paul T. Costa, expanded on Tupes and Christal’s work to create the OCEAN Model of personality. McCrae and Costa originally started examining just three parts of the model, openness, neuroticism, and extroversion,⁴⁴ but the model was later expanded to include both conscientiousness and agreeableness (Figure 3.7).⁴⁵ Before progressing forward, take a minute and complete one of the many different freely available tests of the Five Factor Model of

Personality:

- <https://projects.fivethirtyeight.com/personality-quiz/>,
- <https://openpsychometrics.org/tests/IPIP-BFM/>,
- <https://www.123test.com/personality-test/>,
- <https://www.idrlabs.com/big-five-subscales/test.php>

Openness

Openness refers to “openness to experience,” or the idea that some people are more welcoming of new things. These people are willing to challenge their underlying life assumptions and are more likely to be amenable to differing points of view. Table 3.2 explores some of the traits associated with having both high levels of openness and having low levels of openness.

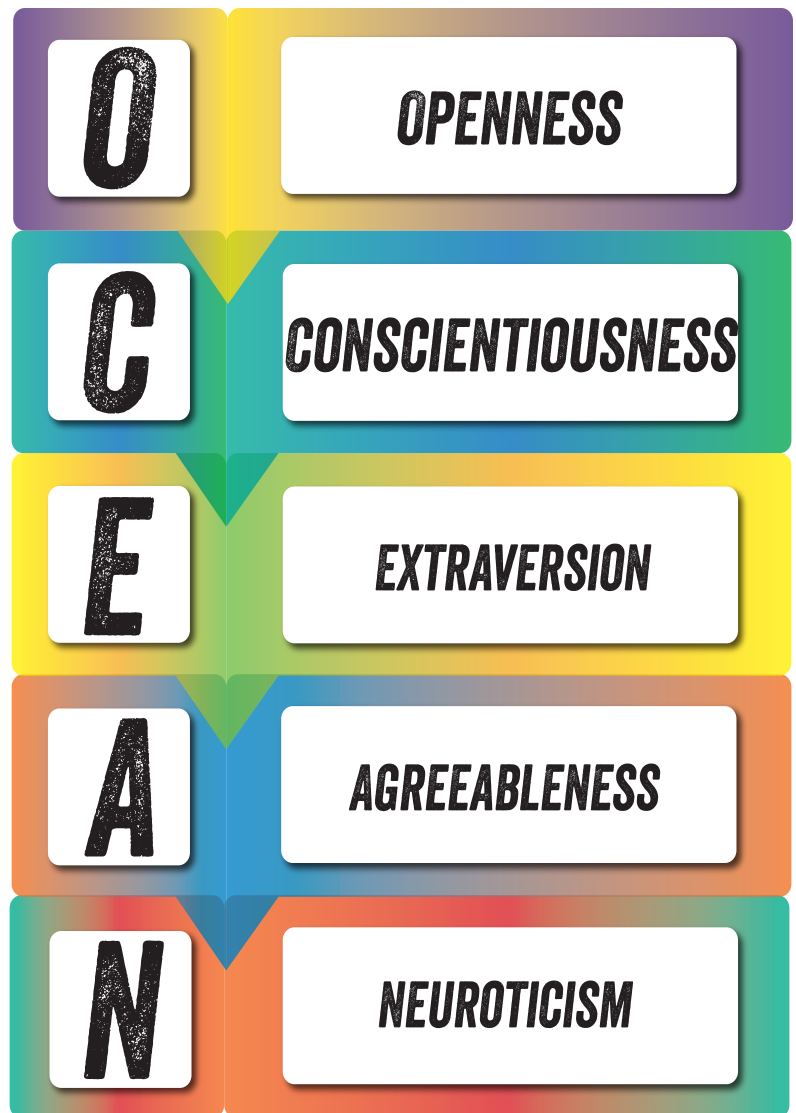

Figure 3.7 OCEAN Model for Personality (The Big Five)

High Openness	Low Openness
Original	Conventional
Creative	Down to Earth
Complex	Narrow Interests
Curious	Unadventurous
Prefer Variety	Conforming
Independent	Traditional
Liberal	Unartistic

Table 3.2. Openness

Conscientiousness

Conscientiousness is the degree to which an individual is aware of their actions and how their actions impact other people. Table 3.3 explores some of the traits associated with having both high levels of conscientiousness and having low levels of conscientiousness.

High Conscientiousness	Low Conscientiousness
Careful	Negligent
Reliable	Disorganized
Hard-Working	Impractical
Self-Disciplined	Thoughtless
Punctual	Playful
Deliberate	Quitting
Knowledgeable	Uncultured

Table 3.3. Conscientiousness

Extraversion

Extraversion is the degree to which someone is sociable and outgoing. Table 3.4 explores some of the traits associated with having both high levels of extraversion and having low levels of extraversion.

High Extraversion	Low Extraversion
Sociable	Sober
Fun Loving	Reserved
Friendly	Quiet
Talkative	Unfeeling
Warm	Lonely
Person-Oriented	Task-Oriented
Dominant	Timid

Table 3.4. Extraversion

Agreeableness

Agreeableness is the degree to which someone engages in prosocial behaviors like altruism, cooperation, and compassion. Table 3.5 explores some of the traits associated with having both high levels of agreeableness and having low levels of agreeableness.

High Agreeableness	Low Agreeableness
Good-Natured	Irritable
Soft Hearted	Selfish
Sympathetic	Suspicious
Forgiving	Critical
Open-Minded	Disagreeable
Flexible	Cynical
Humble	Manipulative

Table 3.5. Agreeableness

Neuroticism

Neuroticism is the degree to which an individual is vulnerable to anxiety, depression, and emotional instability. Table 3.6 explores some of the traits associated with having both high levels of neuroticism and having low levels of neuroticism.

High Neuroticism	Low Neuroticism
Nervous	Calm
High-Strung	Unemotional
Impatient	Secure
Envious/Jealous	Comfortable
Self-Conscious	Not impulse ridden
Temperamental	Hardy
Subjective	Relaxed

Table 3.6. Neuroticism

Research Spotlight



In 2018, Yukti Mehta and Richard Hicks set out to examine the relationship between the Big Five Personality Types (openness, conscientiousness, agreeableness, extroversion, & neuroticism) and the Five Facets of Mindfulness Measure (observation, description, aware actions, non-judgmental inner experience, & nonreactivity). For the purposes of this study, the researchers collapsed the five facets of mindfulness into a single score. The researchers found that openness, conscientiousness, agreeableness, and extroversion were positively related to mindfulness, but neuroticism was negatively related to mindfulness.

Mehta, Y., & Hicks, R. E. (2018). The Big Five, mindfulness, and psychological wellbeing. *Global Science and Technology Forum (GSTF) Journal of Psychology*, 4(1). https://doi.org/10.5176/2345-7929_4.1.103

Cognitive Dispositions

Cognitive dispositions refer to general patterns of mental processes that impact how people respond and react to the world around them. These dispositions (or one's natural mental or emotional outlook) take on several different forms. For our purposes, we'll briefly examine the four identified by John Daly: locus of control, cognitive complexity, authoritarianism/dogmatism, and emotional intelligence.⁴⁶

Locus of Control

One's **locus of control** refers to an individual's perceived control over their behavior and life circumstances. We generally refer to two different loci when discussing locus of control. First, we have people who have an internal locus of control. People with an **internal locus of control** believe that they can control their behavior and life circumstances. For example, people with an internal dating locus of control would believe that their dating lives are ultimately a product of their behaviors and decisions with regard to dating. In other words, my dating life exists because of my choices. The opposite of internal locus of control is the **external locus of control**, or the belief that an individual's behavior and circumstances

exist because of forces outside the individual's control. An individual with an external dating locus of control would believe that their dating life is a matter of luck or divine intervention. This individual would also be more likely to blame outside forces if their dating life isn't going as desired. We'll periodically revisit locus of control in this text because of its importance in a wide variety of interpersonal interactions.

Cognitive Complexity

According to John Daly, cognitive “complexity has been defined in terms of the number of different constructs an individual has to describe others (differentiation), the degree to which those constructs cohere (integration), and the level of abstraction of the constructs (abstractiveness).”⁴⁷ By differentiation, we are talking about the number of distinctions or separate elements an individual can utilize to recognize and interpret an event. For example, in the world of communication, someone who can attend to another individual's body language to a great degree can differentiate large amounts of nonverbal data in a way to understand how another person is thinking or feeling. Someone low in differentiation may only be able to understand a small number of pronounced nonverbal behaviors.

Integration, on the other hand, refers to an individual's ability to see connections or relationships among the various elements he or she has differentiated. It's one thing to recognize several unique nonverbal behaviors, but it's the ability to interpret nonverbal behaviors that enables someone to be genuinely aware of someone else's body language. It would be one thing if I could recognize that someone is smiling, an eyebrow is going up, the head is tilted, and someone's arms are crossed in front. Still, if I cannot see all of these unique behaviors as a total package, then I'm not going to be able to interpret this person's actual nonverbal behavior.

The last part of Daly's definition involves the ability to see levels of abstraction. Abstraction refers to something which exists apart from concrete realities, specific objects, or actual instances. For example, if someone to come right out and verbally tell you that he or she disagrees with something you said, then this person is concretely communicating disagreement, so as the receiver of the disagreement, it should be pretty easy to interpret the disagreement. On the other hand, if someone doesn't tell you he or she disagrees with what you've said but instead provides only small nonverbal cues of disagreement, being able to interpret those theoretical cues is attending to communicative behavior that is considerably more abstract.

Overall, cognitive complexity is a critical cognitive disposition because it directly impacts interpersonal relationships. According to Brant Burleson and Scott Caplan,⁴⁸ cognitive complexity impacts several interpersonal constructs:

1. Form more detailed and organized impressions of others;
2. Better able to remember impressions of others;
3. Better able to resolve inconsistencies in information about others;
4. Learn complex social information quickly; and
5. Use multiple dimensions of judgment in making social evaluations.

In essence, these findings clearly illustrate that cognitive complexity is essential when determining the extent to which an individual can understand and make judgments about others in interpersonal interactions.

Authoritarianism/Dogmatism

According to Jason Wrench, James C. McCroskey, and Virginia Richmond, two personality characteristics that commonly impact interpersonal communication are authoritarianism and dogmatism.⁴⁹ **Author-**

itarianism is a form of social organization where individuals favor absolute obedience to authority (or authorities) as opposed to individual freedom. The highly authoritarian individual believes that individuals should just knowingly submit to their power. Individuals who believe in authoritarianism but are not in power believe that others should submit themselves to those who have power.

Dogmatism, although closely related, is not the same thing as authoritarianism. **Dogmatism** is defined as the inclination to believe one's point-of-view as undeniably true based on faulty premises and without consideration of evidence and the opinions of others. Individuals who are highly dogmatic believe there is generally only one point-of-view on a specific topic, and it's their point-of-view. Highly dogmatic individuals typically view the world in terms of "black and white" while missing most of the shades of grey that exist between. Dogmatic people tend to force their beliefs on others and refuse to accept any variation or debate about these beliefs, which can lead to strained interpersonal interactions. Both authoritarianism and dogmatism "tap into the same broad idea: Some people are more rigid than others, and this rigidity affects both how they communicate and how they respond to communication."⁵⁰

One closely related term that has received some minor exploration in interpersonal communication is right-wing authoritarianism. According to Bob Altemeyer in his book *The Authoritarians* (<http://members.shaw.ca/jeanaltmeyer/drbob/TheAuthoritarians.pdf>), **right-wing authoritarians** (RWAs) tend to have three specific characteristics:

1. RWAs believe in submitting themselves to individuals they perceive as established and legitimate authorities.
2. RWAs believe in strict adherence to social and cultural norms.
3. RWAs tend to become aggressive towards those who do not submit to established, legitimate authorities and those who violate social and cultural norms.

Please understand that Altemeyer's use of the term "right-wing" does not imply the same political connotation that is often associated with it in the United States. As Altemeyer explains, "Because the submission occurs to traditional authority, I call these followers *right-wing* authoritarians. I'm using the word "right" in one of its earliest meanings, for in Old English 'right' (pronounced 'writ') as an adjective meant lawful, proper, correct, doing what the authorities said of others."⁵¹ Under this definition, right-wing authoritarianism is the perfect combination of both dogmatism and authoritarianism.

Right-wing authoritarianism has been linked to several interpersonal variables. For example, parents/guardians who are RWAs are more likely to believe in a highly dogmatic approach to parenting. In contrast, those who are not RWAs tend to be more permissive in their approaches to parenting.⁵² Another study found that men with high levels of RWA were more likely to have been sexually aggressive in the past and were more likely to report sexually aggressive intentions for the future.⁵³ Men with high RWA scores tend to be considerably more sexist and believe in highly traditional sex roles, which impacts how they communicate and interact with women.⁵⁴ Overall, RWA tends to negatively impact interpersonal interactions with anyone who does not see an individual's specific world view and does not come from their cultural background.

Emotional Intelligence

Emotional intelligence is an individual's appraisal and expression of their emotions and the emotions of others in a manner that enhances thought, living, and communicative interactions. Emotional intelligence, while not a new concept, really became popular after Daniel Goleman's book, *Emotional Intelligence*.⁵⁵ Social psychologists had been interested in and studying the importance of emotions long before Goleman's book, but his book seemed to shed new light on an old idea.⁵⁶ Goleman drew quite a bit on

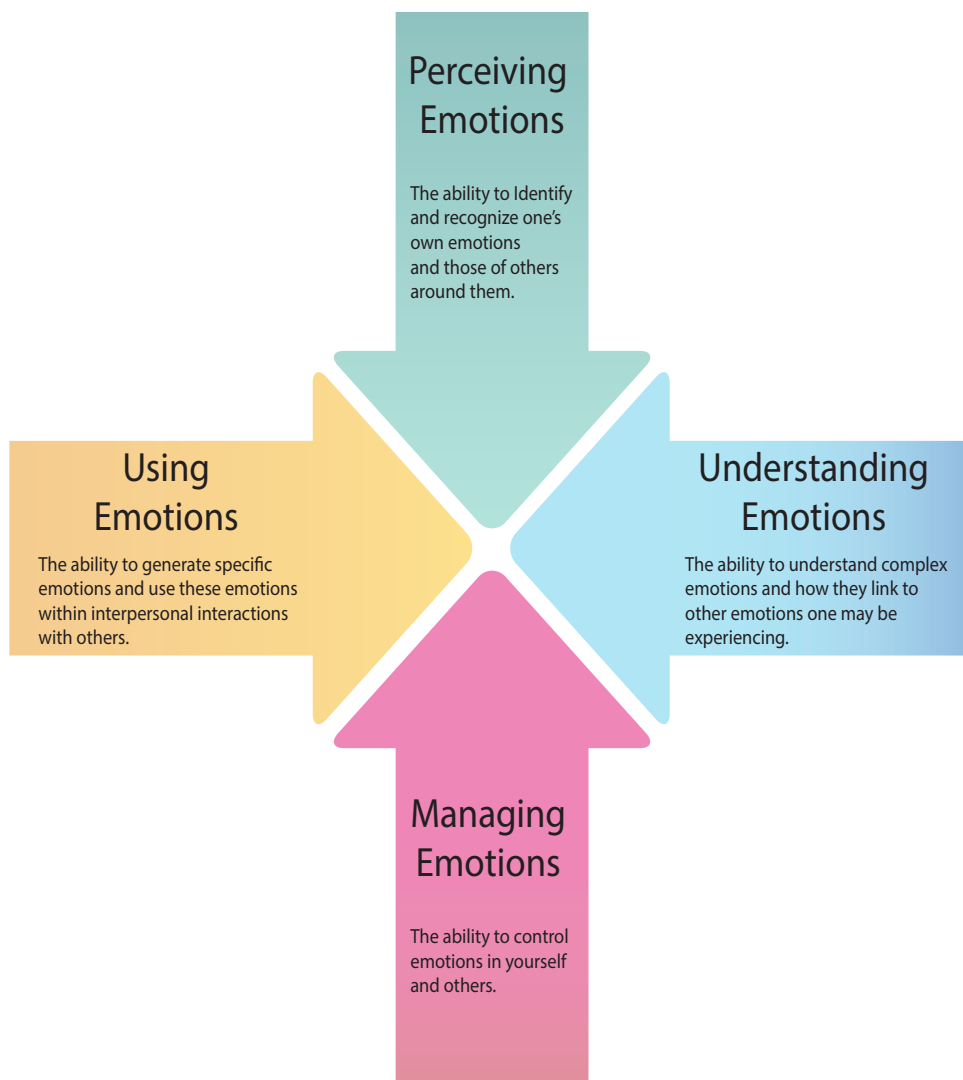

Figure 3.8 Salovey and Mayer’s Emotional Intelligence Model

a framework that was created by two social psychologists named Peter Salovey and John Mayer, who had coined the term “emotional intelligence” in an article in 1990.⁵⁷ In the Salovey and Mayer framework for emotional intelligence, emotional intelligence consisted of four basic processes. Figure 3.8 pictorially demonstrates the four basic parts of Salovey and Mayer’s Emotional Intelligence Model.

Emotional intelligence (EQ) is important for interpersonal communication because individuals who are higher in EQ tend to be more sociable and less socially anxious. As a result of both sociability and lowered anxiety, high EQ individuals tend to be more socially skilled and have higher quality interpersonal relationships.

A closely related

communication construct originally coined by Melanie and Steven Booth-Butterfield is **affective orientation**.⁵⁸ As it is conceptualized by the Booth-Butterfields, affective orientation (AO) is “the degree to which people are aware of their emotions, perceive them as important, and actively consider their affective responses in making judgments and interacting with others.”⁵⁹ Under the auspices of AO, the general assumption is that highly affective-oriented people are (1) cognitively aware of their own and others’ emotions, and (2) can implement emotional information in communication with others. Not surprisingly, the Booth-Butterfields found that highly affective-oriented individuals also reported greater affect intensity in their relationships.

Melanie and Steven Booth-Butterfield later furthered their understanding of AO by examining it in terms of how an individual’s emotions drive their decisions in life.⁶⁰ As the Booth-Butterfields explain, in their further conceptualization of AO, they “are primarily interested in those individuals who not only sense and value their emotions but scrutinize and give them weight to direct behavior.”⁶¹ In this sense, the Booth-Butterfields are expanding our notion of AO by explaining that some individuals use their emotions as a guiding force for their behaviors and their lives. On the other end of the spectrum, you have individuals who use no emotional information in how they behave and guide their lives.

Although relatively little research has examined AO, the conducted research indicates its importance in interpersonal relationships. For example, in one study, individuals who viewed their parents/guardians as having high AO levels reported more open communication with those parents/guardians.⁶²

Personal-Social Dispositions

Social-personal dispositions refer to general patterns of mental processes that impact how people socially relate to others or view themselves. All of the following dispositions impact how people interact with others, but they do so from very different places. Without going into too much detail, we are going to examine the seven personal-social dispositions identified by John Daly.⁶³

Loneliness

The first social-personal disposition is **loneliness** or an individual's emotional distress that results from a feeling of solitude or isolation from social relationships. Loneliness can generally be discussed as existing in one of two forms: emotional and social. **Emotional loneliness** results when an individual feels that he or she does not have an emotional connection with others. We generally get these emotional connections through our associations with loved ones and close friends. If an individual is estranged from their family or doesn't have close friendships, then he or she may feel loneliness as a result of a lack of these emotional relationships. **Social loneliness**, on the other hand, results from a lack of a satisfying social network. Imagine you're someone who has historically been very social. Still, you move to a new city and find building new social relationships very difficult because the people in the new location are very cliquy. The inability to develop a new social network can lead someone to feelings of loneliness because he or she may feel a sense of social boredom or marginalization.

Loneliness tends to impact people in several different ways interpersonally. Some of the general research findings associated with loneliness have demonstrated that these people have lower self-esteem, are more socially passive, are more sensitive to rejection from others, and are often less socially skilled. Interestingly, lonely individuals tend to think of their interpersonal failures using an internal locus of control and their interpersonal successes externally.⁶⁴

Depression

Depression is a psychological disorder characterized by varying degrees of disappointment, guilt, hopelessness, loneliness, sadness, and self-doubt, all of which negatively impact a person's general mental and physical wellbeing. Depression (and all of its characteristics) is very difficult to encapsulate in a single definition. If you've ever experienced a major depressive episode, it's a lot easier to understand what depression is compared to those who have never experienced one. Depressed people tend to be less satisfied with life and less satisfied with their interpersonal interactions as well. Research has shown that depression negatively impacts all forms of interpersonal relationships: dating, friends, families, work, etc. We will periodically come back to depression as we explore various parts of interpersonal communication.

Self-Esteem

As discussed earlier in this chapter, self-esteem consists of your sense of self-worth and the level of satisfaction you have with yourself; it is how you feel about yourself. A good self-image raises your self-esteem; a poor self-image often results in poor self-esteem, lack of confidence, and insecurity. Not surprisingly,

individuals with low self-esteem tend to have more problematic interpersonal relationships.

Narcissism

Ovid's story of Narcissus and Echo has been passed down through the ages. The story starts with a Mountain Nymph named Echo who falls in love with a human named Narcissus. When Echo reveals herself to Narcissus, he rejects her. In true Roman fashion, this slight could not be left unpunished. Echo eventually leads Narcissus to a pool of water where he quickly falls in love with his reflection. He ultimately dies, staring at himself, because he realizes that his love will never be met.

The modern conceptualization of narcissism is based on Ovid's story of Narcissus. Today researchers view **narcissism** as a psychological condition (or personality disorder) in which a person has a preoccupation with one's self, an inflated sense of one's importance, and longing of admiration from others. Highly narcissistic individuals are completely self-focused and tend to ignore the communicative needs and emotions of others. In fact, in social situations, highly narcissistic individuals strive to be the center of attention.

Anita Vangelisti, Mark Knapp, and John Daly examined a purely communicative form of narcissism they deemed conversational narcissism.⁶⁵ Conversational narcissism is an extreme focusing of one's interests and desires during an interpersonal interaction while completely ignoring the interests and desires of another person: Vangelisti, Knapp, and Daly found four general categories of conversationally narcissistic behavior. First, conversational narcissists inflate their self-importance while displaying an inflated self-image. Some behaviors include bragging, refusing to listen to criticism, praising one's self, etc. Second, conversational narcissists exploit a conversation by attempting to focus the direction of the conversation on topics of interest to them. Some behaviors include talking so fast others cannot interject, shifting the topic to one's self, interrupting others, etc. Third, conversational narcissists are exhibitionists, or they attempt to show-off or entertain others to turn the focus on themselves. Some behaviors include primping or preening, dressing to attract attention, being or laughing louder than others, positioning one's self in the center, etc. Lastly, conversational narcissists tend to have impersonal relationships. During their interactions with others, conversational narcissists show a lack of caring about another person and a lack of interest in another person. Some common behaviors include "glazing over" while someone else is speaking, looking impatient while someone is speaking, looking around the room while someone is speaking, etc. As you can imagine, people engaged in interpersonal encounters with conversational narcissists are generally highly unsatisfied with those interactions.

Machiavellianism

In 1513, Nicolo Machiavelli (Figure 3.9) wrote a text called *The Prince* (<http://www.gutenberg.org/files/1232/1232-h/1232-h.htm>). Although Machiavelli dedicated the book to Lorenzo di Piero de' Medici, who was a member of the ruling Florentine Medici family, the book was originally scribed for Lorenzo's uncle. In *The Prince*, Nicolo Machiavelli unabashedly describes how he believes leaders should keep power. First, he notes that traditional leadership virtues like decency, honor, and trust should be discarded for a more calculating approach to leadership. Most specifically, Machiavelli believed that humans were easily manipulated, so ultimately, leaders can either be the ones influencing their followers or wait for someone else to wield that influence in a different direction.

In 1970, two social psychologists named Richard Christie and Florence Geis decided to see if Machiavelli's ideas were still in practice in the 20th Century.⁶⁶ The basic model that Christie and Geis proposed consisted of four basic Machiavellian characteristics:

1. Lack of affect in interpersonal relationships (relationships are a means to an end);
2. Lack of concern with conventional morality (people are tools to be used in the best way possible);
3. Rational view of others not based on psychopathology (people who actively manipulate others must be logical and rational); and
4. Focused on short-term tasks rather than long-range ramifications of behavior (these individuals have little ideological/organizational commitment).

Imagine working with one of these people.

Imagine being led by one of these people. Part of their research consisted of creating a research questionnaire to measure one's tendency towards **Machiavellianism**. The questionnaire has undergone several revisions, but the most common one is called the Mach IV (<http://personality-testing.info/tests/MACH-IV.php>).

Interpersonally, highly Machiavellian people tend to see people as stepping stones to get what they want. If talking to someone in a particular manner makes that other people feel good about themselves, the Machiavellian has no problem doing this if it helps the Machiavellian get what he or she wants. Ultimately, Machiavellian behavior is very problematic. In interpersonal interactions where the receiver of a Machiavellian's attempt of manipulation is aware of the manipulation, the receiver tends to be highly unsatisfied with these communicative interactions. However, someone who is truly adept at the art of manipulation may be harder to recognize than most people realize.

Empathy

Empathy is the ability to recognize and mutually experience another person's attitudes, emotions, experiences, and thoughts. Highly empathic individuals have the unique ability to connect with others interpersonally, because they can truly see how the other person is viewing life. Individuals who are unempathetic generally have a hard time taking or seeing another person's perspective, so their interpersonal interactions tend to be more rigid and less emotionally driven. Generally speaking, people who have high levels of empathy tend to have more successful and rewarding interactions with others when compared to unempathetic individuals. Furthermore, people who are interacting with a highly empathetic person tend to find those interactions more satisfying than when interacting with someone who is unempathetic.

Self-Monitoring

The last of the personal-social dispositions is referred to as self-monitoring. In 1974 Mark Snyder devel-



Figure 3.9 Nicolo Machiavelli

oped his basic theory of **self-monitoring**, which proposes that individuals differ in the degree to which they can control their behaviors following the appropriate social rules and norms involved in interpersonal interaction.⁶⁷ In this theory, Snyder proposes that there are some individuals adept at selecting appropriate behavior in light of the context of a situation, which he deems high self-monitors. High self-monitors want others to view them in a precise manner (impression management), so they enact communicative behaviors that ensure suitable or favorable public appearances. On the other hand, some people are merely unconcerned with how others view them and will act consistently across differing communicative contexts despite the changes in cultural rules and norms. Snyder called these people low self-monitors.

Interpersonally, high self-monitors tend to have more meaningful and satisfying interpersonal interactions with others. Conversely, individuals who are low self-monitors tend to have more problematic and less satisfying interpersonal relationships with others. In romantic relationships, high self-monitors tend to develop relational intimacy much faster than individuals who are low self-monitors. Furthermore, high self-monitors tend to build lots of interpersonal friendships with a broad range of people. Low-self-monitors may only have a small handful of friends, but these friendships tend to have more depth. Furthermore, high self-monitors are also more likely to take on leadership positions and get promoted in an organization when compared to their low self-monitoring counterparts. Overall, self-monitoring is an important dispositional characteristic that impacts interpersonal relationships.

Key Takeaways

- Personality and temperament have many overlapping characteristics, but the basis of them is fundamentally different. Personality is the product of one's social environment and is generally developed later in one's life. Temperament, on the other hand, is one's innate genetic predisposition that causes an individual to behave, react, and think in a specific manner, and it can easily be seen in infants.
- In both the scientific literature and in pop culture, there are many personality/temperament schemes that involve four specific parts. Table 3.1, in this chapter, showed a range of different personality quizzes/measures/tests that break temperament down into these four generic categories.
- In this section, we examined a range of different cognitive dispositions or personal-social dispositions. The cognitive dispositions (general patterns of mental processes that impact how people respond and react to the world around them) discussed in this chapter were the locus of control, cognitive complexity, authoritarianism, dogmatism, emotional intelligence, and AO. The social-personal dispositions (general patterns of mental processes that impact how people socially relate to others or view themselves) discussed in this chapter were loneliness, depression, self-esteem, narcissism, Machiavellianism, empathy, and self-monitoring.

Exercises

- Complete the Keirsey Temperament Sorter®-II (KTS®-II; <http://www.keirsey.com/sorter/register.aspx>). After finding out your temperament, reflect on what your temperament says about how you interact with people interpersonally.

- Watch the following interview conducted by Allan Gregg with Daniel Goleman (the individual who popularized emotional intelligence) (<http://www.youtube.com/watch?v=NeJ3FF1yFyc>). After watching the interview with Goleman, what did you learn about emotional intelligence? How can you apply emotional intelligence in your own life?
- Complete the Self-Monitoring Scale created by Mark Snyder (<http://personality-testing.info/tests/SM.php>). After finishing the scale, what do your results say about your ability to adapt to changing interpersonal situations and contexts?

3.3 Communication & Relational Dispositions

LEARNING

OUTCOMES

1. List and explain the different personality traits associated with Daly's communication dispositions.
2. List and explain the different personality traits associated with Daly's relational dispositions.

In the previous section, we explored the importance of temperament, cognitive dispositions, and personal-social dispositions. In this section, we are going to explore the last two dispositions discussed by John Daly: communication and relational dispositions.⁶⁸

Communication Dispositions

Now that we've examined cognitive and personal-social dispositions, we can move on and explore some intrapersonal dispositions studied specifically by communication scholars. **Communication dispositions** are general patterns of communicative behavior. We are going to explore the nature of introversion/extraversion, approach and avoidance traits, argumentativeness/verbal aggressiveness, and lastly, sociocommunicative orientation.

Introversion/Extraversion

The concept of **introversion/extraversion** is one that has been widely studied by both psychologists and communication researchers. The idea is that people exist on a continuum that exists from highly extraverted (an individual's likelihood to be talkative, dynamic, and outgoing) to highly introverted (an individual's likelihood to be quiet, shy, and more reserved). Before continuing, take a second and fill out the Introversion Scale created by James C. McCroskey and available on his website (<http://www.jamesc-mccroskey.com/measures/introversion.htm>). There is a considerable amount of research that has found an individual's tendency toward extraversion or introversion is biologically based.⁶⁹ As such, where you score on the Introversion Scale may largely be a factor of your genetic makeup and not something you can alter greatly.

When it comes to interpersonal relationships, individuals who score highly on extraversion tended to be perceived by others as intelligent, friendly, and attractive. As such, extraverts tend to have more opportunities for interpersonal communication; it's not surprising that they tend to have better

communicative skills when compared to their more introverted counterparts.

Approach and Avoidance Traits

The second set of communication dispositions are categorized as approach and avoidance traits. According to Virginia Richmond, Jason Wrench, and James McCroskey, approach and avoidance traits depict the tendency an individual has to either willingly approach or avoid situations where he or she will have to communicate with others.⁷⁰ To help us understand the approach and avoidance traits, we'll examine three specific traits commonly discussed by communication scholars: shyness, communication apprehension, and willingness to communicate.

Shyness

In a classic study conducted by Philip Zimbardo, he asked two questions to over 5,000 participants: Do you presently consider yourself to be a shy person? If “No,” was there ever a period in your life during which you considered yourself to be a shy person?⁷¹ The results of these two questions were quite surprising. Over 40% said that they considered themselves to be currently shy. Over 80% said that they had been shy at one point in their lifetimes. Another, more revealing measure of shyness, was created by James C. McCroskey and Virginia Richmond and is available on his website (<http://www.jamesmccroskey.com/measures/shyness.htm>).⁷² Before going further in this chapter, take a minute and complete the shyness scale.

According to Arnold Buss, shyness involves discomfort when an individual is interacting with another person(s) in a social situation.⁷³ Buss further clarifies the concept by differentiating between anxious shyness and self-conscious shyness. **Anxious shyness** involves the fear associated with dealing with others face-to-face. Anxious shyness is initially caused by a combination of strangers, novel settings, novel social roles, fear of evaluation, or fear of self-presentation. However, long-term anxious shyness is generally caused by chronic fear, low sociability, low self-esteem, loneliness, and avoidance conditioning. **Self-conscious shyness**, on the other hand, involves feeling conspicuous or socially exposed when dealing with others face-to-face. Self-conscious shyness is generally initially caused by feelings of conspicuousness, breaches of one's privacy, teasing/ridicule/bullying, overpraise, or one's foolish actions. However, long-term self-conscious shyness can be a result of socialization, public self-consciousness, history of teasing/ridicule/bullying, low self-esteem, negative appearance, and poor social skills.

Whether one suffers from anxious or self-conscious shyness, the general outcome is a detriment to an individual's interpersonal interactions with others. Generally speaking, shy individuals have few opportunities to engage in interpersonal interactions with others, so their communicative skills are not as developed as their less-shy counterparts. This lack of skill practice tends to place a shy individual in a never-ending spiral where he or she always feels just outside the crowd.

Communication Apprehension

James C. McCroskey started examining the notion of anxiety in communicative situations during the late 1960s. Since that time, research on communication apprehension has been one of the most commonly studied variables in the field. McCroskey defined **communication apprehension** as the fear or anxiety “associated with either real or anticipated communication with another person or persons.”⁷⁴ Although many different measures have been created over the years examining communication apprehension, the most prominent one has been James C. McCroskey's Personal Report of Communication Apprehen-

sion-24 (PRCA-24).⁷⁵ If you have not done so already, please stop reading and complete the PRCA-24 before going further (<http://www.jamescmcroskey.com/measures/prca24.htm>).

The PRCA-24 evaluates four distinct types of communication apprehension (CA): interpersonal CA, group CA, meeting CA, and public CA. Interpersonal CA is the one most important to us within this textbook because it examines the extent to which individuals experience fear or anxiety when thinking about or actually interacting with another person (For more on the topic of CA as a general area of study, read Richmond, Wrench, and McCroskey's book, *Communication Apprehension, Avoidance, and Effectiveness*⁷⁶). Interpersonal CA impacts people's relationship development almost immediately. In one experimental study, researchers paired people and had them converse for 15 minutes. At the end of the 15-minute conversation, the researchers had both parties rate the other individual. The results indicated that high-CAs (highly communicative apprehensive people) were perceived as less attractive, less trustworthy, and less satisfied than low-CAs (people with low levels of communication apprehension).⁷⁷ Generally speaking, high-CAs don't tend to fare well in most of the research in interpersonal communication. Instead of going into too much detail at this point, we will periodically revisit CA as we explore several different topics in this book.

Research Spotlight



In 2019, Jason Wrench, Narissra, Punyanunt-Carter, and Adolfo Garcia examined the relationships between mindfulness and religious communication. For our purposes, the researchers examined an individual's religious CA, or the degree to which people were anxious about communicating with another person about their personally held religious beliefs. In this study, mindful describing and nonreactivity to inner experience was found to be negatively related to religious CA. As the authors note, "mindfulness can help people develop more confidence to communicate their ideas and opinions about religion. Therefore, people would be less apprehensive about communicating about religion" (pg. 13).

Wrench, J. S., Punyanunt-Carter, N. M., & Garcia, A. J. (2019).

Understanding college students' perceptions regarding mindfulness: The impact on intellectual humility, faith development, religious communication apprehension, and religious communication. *Journal of Religion and Health*. <https://doi.org/10.1007/s10943-019-00861-3>

Willingness to Communicate

The final of our approach and avoidance traits is the willingness to communicate (WTC). James McCroskey and Virginia Richmond originally coined the WTC concept as an individual's predisposition to initiate communication with others.⁷⁸ **Willingness to communicate** examines an individual's tendency to initiate communicative interactions with other people. Take a minute and complete the WTC scale available from James C. McCroskey's website (<http://www.jamescmcroskey.com/measures/WTC.htm>).

People who have high WTC levels are going to be more likely to initiate interpersonal interactions than those with low WTC levels. However, just because someone is not likely to initiate conversations doesn't mean that he or she is unable to actively and successfully engage in interpersonal interactions. For this reason, we refer to WTC as an approach trait because it describes an individual's likelihood of approaching interactions with other people. As noted by Richmond et al., "People with a high WTC attempt to communicate more often and work harder to make that communication effective than people with a low WTC, who make far fewer attempts and often aren't as effective at communicating."⁷⁹

Argumentativeness/Verbal Aggressiveness

Starting in the mid-1980s, Dominic Infante and Charles Wigley defined **verbal aggression** as “the tendency to attack the self-concept of individuals instead of, or in addition to, their positions on topics of communication.”⁸⁰ Notice that this definition specifically is focused on the attacking of someone’s self-concept or an individual’s attitudes, opinions, and cognitions about one’s competence, character, strengths, and weaknesses. For example, if someone perceives themselves as a good worker, then a verbally aggressive attack would demean that person’s quality of work or their ability to do future quality work. In a study conducted by Terry Kinney,⁸¹ he found that self-concept attacks happen on three basic fronts: group membership (e.g., “Your whole division is a bunch of idiots!”), personal failings (e.g., “No wonder you keep getting passed up for a promotion!”), and relational failings (e.g., “No wonder your spouse left you!”).

Now that we’ve discussed what verbal aggression is, we should delineate verbal aggression from another closely related term, argumentativeness. According to Dominic Infante and Andrew Rancer, **argumentativeness** is a communication trait that “predisposes the individual in communication situations to advocate positions on controversial issues, and to attacking verbally the positions which other people take on these issues.”⁸² You’ll notice that argumentativeness occurs when an individual attacks another’s positions on various issues; whereas, verbal aggression occurs when an individual attacks someone’s self-concept instead of attack another’s positions. Argumentativeness is seen as a constructive communication trait, while verbal aggression is a destructive communication trait.

Individuals who are highly verbally aggressive are not liked by those around them.⁸³ Researchers have seen this pattern of results across different relationship types. Highly verbally aggressive individuals tend to justify their verbal aggression in interpersonal relationships regardless of the relational stage (new vs. long-term relationship).⁸⁴ In an interesting study conducted by Beth Semic and Daniel Canary, the two set out to watch interpersonal interactions and the types of arguments formed during those interactions based on individuals’ verbal aggressiveness and argumentativeness.⁸⁵ The researchers had friendship-dyads come into the lab and were asked to talk about two different topics. The researchers found that highly argumentative individuals did not differ in the number of arguments they made when compared to their low argumentative counterparts. However, highly verbally aggressive individuals provided far fewer arguments when compared to their less verbally aggressive counterparts. Although this study did not find that highly argumentative people provided more (or better) arguments, highly verbally aggressive people provided fewer actual arguments when they disagreed with another person. Overall, verbal aggression and argumentativeness have been shown to impact several different interpersonal relationships, so we will periodically revisit these concepts throughout the book.

Sociocommunicative Orientation

In the mid to late 1970s, Sandra Bem began examining psychological gender orientation.⁸⁶ In her theorizing of psychological gender, Bem measured two constructs, masculinity and femininity, using a scale she created called the Bem Sex-Role Inventory (BSRI—<http://garote.bdmonkeys.net/bsri.html>). Her measure was designed to evaluate an individual’s femininity or masculinity. Bem defined masculinity as individuals exhibiting perceptions and traits typically associated with males, and femininity as individuals exhibiting perceptions and traits usually associated with females. Individuals who adhered to both their biological sex and their corresponding psychological gender (masculine males, feminine females) were considered sex-typed. Individuals who differed between their biological sex and their corresponding psychological

gender (feminine males, masculine females) were labeled cross-sex typed. Lastly, some individuals exhibited both feminine and masculine traits, and these individuals were called androgynous.

Virginia Richmond and James McCroskey opted to discard the biological sex-biased language of “masculine” and “feminine” for the more neutral language of “assertiveness” and “responsiveness.”⁸⁷ The combination of assertiveness and responsiveness was called someone’s **sociocommunicative orientation**, which emphasizes that Bem’s notions of gender are truly representative of communicator traits and not one’s biological sex. Before talking about the two factors of sociocommunicative orientation, please take a few minutes to complete the Sociocommunicative Orientation Scale (<http://www.jamesmccroskey.com/measures/sco.htm>).⁸⁸

Responsiveness

Responsiveness refers to an individual who “considers other’s feelings, listens to what others have to say, and recognizes the needs of others.”⁸⁹ If you filled out the Sociocommunicative Orientation Scale, you would find that the words associated with responsiveness include the following: helpful, responsive to others, sympathetic, compassionate, sensitive to the needs of others, sincere, gentle, warm, tender, and friendly.

Assertiveness

Assertiveness refers to individuals who “can initiate, maintain, and terminate conversations, according to their interpersonal goals.”⁹⁰ If you filled out the Sociocommunicative Orientation Scale, you would find that the words associated with assertiveness include the following: defends own beliefs, independent, forceful, has a strong personality, assertive, dominant, willing to take a stand, acts as a leader, aggressive, and competitive.

Versatility

Communication always exists within specific contexts, so picking a single best style to communicate in every context simply can’t be done because not all patterns of communication are appropriate or effective in all situations. As such, McCroskey and Richmond added a third dimension to the mix that they called **versatility**.⁹¹ In essence, individuals who are competent communicators know when it is both appropriate and effective to use both responsiveness and assertiveness. The notion of pairing the two terms against each other did not make sense to McCroskey and Richmond because both were so important. Other terms scholars have associated with versatility include “adaptability, flexibility, rhetorical sensitivity, and style flexing.”⁹² The opposite of versatility was also noted by McCroskey and Richmond, who saw such terms as dogmatic, rigid, uncompromising, and unyielding as demonstrating the lack of versatility.

Sociocommunicative Orientation and Interpersonal Communication

Sociocommunicative orientation has been examined in several studies that relate to interpersonal communication. In a study conducted by Brian Patterson and Shawn Beckett, the researchers sought to see the importance of sociocommunicative orientation and how people repair relationships.⁹³ Highly assertive individuals were found to take control of repair situations. Highly responsive individuals, on the other hand, tended to differ in their approaches to relational repair, depending on whether the target was perceived as assertive or responsive. When a target was perceived as highly assertive, the responsive individual tended to let the assertive person take control of the relational repair process. When a target was

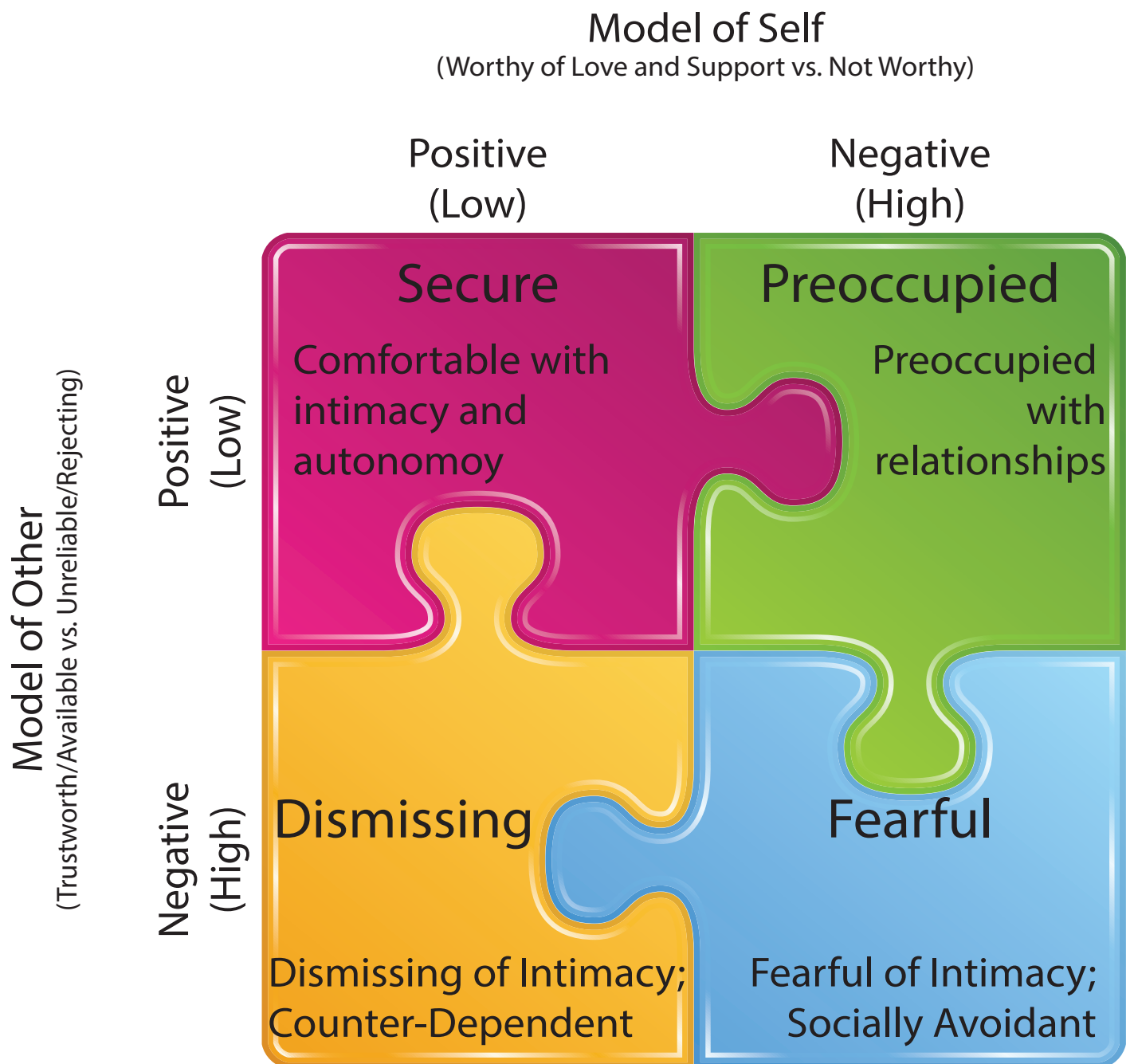

perceived as highly responsive. The responsive individual was more likely to encourage the other person to self-disclose and took on the role of the listener. As a whole, highly assertive individuals were more likely to stress the optimism of the relationship, while highly responsive individuals were more likely to take on the role of a listener during the relational repair. Later in this book, we will revisit several different interpersonal communication contexts where sociocommunicative orientation has been researched.

Relational Dispositions

The final three dimensions proposed by John Daly were relational dispositions.⁹⁴ **Relational dispositions** are general patterns of mental processes that impact how people view and organize themselves in relationships. For our purposes, we'll examine two unique relational dispositions: attachment and rejec-

tion sensitivity.

Attachment

In a set of three different volumes, John Bowlby theorized that humans were born with a set of inherent behaviors designed to allow proximity with supportive others.⁹⁵ These behaviors were called attachment behaviors, and the supportive others were called attachment figures. Inherent in Bowlby's model of attachment is that humans have a biological drive to attach themselves with others. For example, a baby's crying and searching help the baby find their attachment figure (typically a parent/guardian) who can provide care, protection, and support. Infants (and adults) view attachment as an issue of whether an attachment figure is nearby, accessible, and attentive? Bowlby believed that these interpersonal models, which were developed in infancy through thousands of interactions with an attachment figure, would influence an individual's interpersonal relationships across their entire life span. According to Bowlby, the basic internal working model of affection consists of three components.⁹⁶ Infants who bond with their attachment figure during the first two years develop a model that people are trustworthy, develop a model that informs the infant that he or she is valuable, and develop a model that informs the infant that he or she is effective during interpersonal interactions. As you can easily see, not developing this model during infancy leads to several problems.

If there is a breakdown in an individual's relationship with their attachment figure (primarily one's mother), then the infant would suffer long-term negative consequences. Bowlby called his ideas on the importance of mother-child attachment and the lack thereof as the **Maternal Deprivation Hypothesis**. Bowlby hypothesized that maternal deprivation occurred as a result of separation from or loss of one's mother or a mother's inability to develop an attachment with her infant. This attachment is crucial during the first two years of a child's life. Bowlby predicted that children who were deprived of attachment (or had a sporadic attachment) would later exhibit delinquency, reduced intelligence, increased aggression, depression, and **affectionless psychopathy** - the inability to show affection or care about others.

In 1991, Kim Bartholomew and Leonard Horowitz expanded on Bowlby's work developing a scheme for understanding adult attachment.⁹⁷ In this study, Bartholomew and Horowitz proposed a model for understanding adult attachment. On one end of the spectrum, you have an individual's abstract image of themselves as being either worthy of love and support or not. On the other end of the spectrum, you have an individual's perception of whether or not another person will be trustworthy/available or another person is unreliable and rejecting. When you combine these dichotomies, you end up with four distinct attachment styles (as seen in Figure 3.10).

The first attachment style is labeled "**secure**," because these individuals believe that they are loveable and expect that others will generally behave in accepting and responsive ways within interpersonal interactions. Not surprisingly, secure individuals tend to show the most satisfaction, commitment, and trust in their relationships. The second attachment style, **preoccupied**, occurs when someone does not perceive themselves as worthy of love but does generally see people as trustworthy and available for interpersonal relationships. These individuals would attempt to get others to accept them. The third attachment style, **fearful** (sometimes referred to as fearful avoidants⁹⁸), represents individuals who see themselves as unworthy of love and generally believe that others will react negatively through either deception or rejection. These individuals simply avoid interpersonal relationships to avoid being rejected by others. Even in communication, fearful people may avoid communication because they simply believe that others will not provide helpful information or others will simply reject their communicative attempts.

The final attachment style, **dismissing**, reflects those individuals who see themselves as worthy of love, but generally believes that others will be deceptive and reject them in interpersonal relationships. These people tend to avoid interpersonal relationships to protect themselves against disappointment that occurs from placing too much trust in another person or making one's self vulnerable to rejection.

Rejection Sensitivity

Although no one likes to be rejected by other people in interpersonal interactions, most of us do differ from one another in how this rejection affects us as humans. We've all had our relational approaches (either by potential friends or dating partners) rejected at some point and know that it kind of sucks to be rejected. The idea that people differ in terms of degree in how sensitive they are to rejection was first discussed in the 1930s by a German psychoanalyst named Karen Horney.⁹⁹ **Rejection sensitivity** can be defined as the degree to which an individual expects to be rejected, readily perceives rejection when occurring, and experiences an intensely adverse reaction to that rejection.

First, people that are highly sensitive to rejection expect that others will reject them. This expectation of rejection is generally based on a multitude of previous experiences where the individual has faced real rejection. Hence, they just assume that others will reject them.

Second, people highly sensitive to rejection are more adept at noting when they are being rejected; however, it's not uncommon for these individuals to see rejection when it does not exist. Horney explains perceptions of rejection in this fashion:

It is difficult to describe the degree of their sensitivity to rejection. Change in an appointment, having to wait, failure to receive an immediate response, disagreement with their opinions, any noncompliance with their wishes, in short, any failure to fulfill their demands on their terms, is felt as a rebuff. And a rebuff not only throws them back on their basic anxiety, but it is also considered equivalent to humiliation.¹⁰⁰

As we can see from this short description from Horney, rejection sensitivity can occur from even the slightest perceptions of being rejected.

Lastly, individuals who are highly sensitive to rejection tend to react negatively when they feel they are being rejected. This negative reaction can be as simple as just not bothering to engage in future interactions or even physical or verbal aggression. The link between the rejection and the negative reaction may not even be completely understandable to the individual. Horney explains, "More often the connection between feeling rebuffed and feeling irritated remains unconscious. This happens all the more easily since the rebuff may have been so slight as to escape conscious awareness. Then a person will feel irritable, or become spiteful and vindictive or feel fatigued or depressed or have a headache, without the remotest suspicion why."¹⁰¹ Ultimately, individuals with high sensitivity to rejection can develop a "why bother" approach to initiating new relationships with others. This fear of rejection eventually becomes a self-induced handicap that prevents these individuals from receiving the affection they desire.

As with most psychological phenomena, this process tends to proceed through a series of stages. Horney explains that individuals suffering from rejection sensitivity tend to undergo an eight-step cycle:

1. Fear of being rejected.
2. Excessive need for affection (e.g., demands for exclusive and unconditional love).
3. When the need is not met, they feel rejected.
4. The individual reacts negatively (e.g., with hostility) to the rejection.
5. Repressed hostility for fear of losing the affection.
6. Unexpressed rage builds up inside.

7. Increased fear of rejection.
8. Increased need for relational reassurance from a partner.

Of course, as an individual's need for relational reassurance increases, so does their fear of being rejected, and the perceptions of rejection spiral out of control.

As you may have guessed, there is a strong connection between John Bowlby's attachment theory¹⁰² and Karen Horney's theory of rejection sensitivity. As you can imagine, rejection sensitivity has several implications for interpersonal communication. In a study conducted by Geraldine Downey, Antonio Freitas, Benjamin Michaelis, and Hala Khouri, the researchers wanted to track high versus low rejection sensitive individuals in relationships and how long those relationships lasted.¹⁰³ The researchers also had the participants complete the Rejection Sensitivity Questionnaire created by Geraldine Downey and Scott Feldman.¹⁰⁴ The study started by having couples keep diaries for four weeks, which helped the researchers develop a baseline perception of an individual's sensitivity to rejection during the conflict. After the initial four-week period, the researchers revisited the participants one year later to see what had happened. Not surprisingly, high rejection sensitive individuals were more likely to break up during the study than their low rejection sensitivity counterparts.

Key Takeaways

- The idea is that people exist on a continuum from highly extraverted (an individual's likelihood to be talkative, dynamic, and outgoing) to highly introverted (an individual's likelihood to be quiet, shy, and more reserved). Generally speaking, highly extraverted individuals tend to have a greater number of interpersonal relationships, but introverted people tend to have more depth in the handful of relationships they have.
- In this chapter, three approach and avoidance traits were discussed: willingness to communicate, shyness, and communication apprehension. Willingness to communicate refers to an individual's tendency to initiate communicative interactions with other people. Shyness refers to discomfort when an individual is interacting with another person(s) in a social situation. Communication apprehension is the fear or anxiety associated with either real or anticipated communication with another person or persons. Where WTC examines initiation of interpersonal interactions, shyness discusses actual reserved interpersonal behavior, and CA is focused on the anxiety experienced (or perceived) in interpersonal interactions.
- Argumentativeness refers to an individual's tendency to engage in the open exchange of ideas in the form of arguments; whereas, verbal aggressiveness is the tendency to attack an individual's self-concept instead of an individual's arguments.
- Sociocommunicative orientation refers to an individual's combination of both assertive and responsive communication behaviors. Assertive communication behaviors are those that initiate, maintain, and terminate conversations according to their interpersonal goals during interpersonal interactions. Responsive communication behaviors are those that consider others' feelings, listens to what others have to say, and recognizes the needs of others during interpersonal interactions. Individuals who can appropriately and effectively utilize assertive and responsive behaviors during interpersonal communication across varying contexts are referred to as versatile communicators (or competent communicators).

- John Bowlby's theory of attachment starts with the basic notion that infants come pre-equipped with a set of behavioral skills that allow them to form attachments with their parents/guardians (specifically their mothers). When these attachments are not formed, the infant will grow up being unable to experience a range of healthy attachments later in life, along with several other counterproductive behaviors.
- Karen Horney's concept of rejection sensitivity examines the degree to which an individual anxiously expects to be rejected, readily perceives rejection when occurring, and experiences an intensely negative reaction to that rejection. People that have high levels of rejection sensitivity tend to create relational cycles that perpetuate a self-fulfilling prophecy of rejection in their interpersonal relationships.

Exercises

- Fill out the various measures discussed in this section related to communication. After completing these measures, how can your communication traits help explain your interpersonal relationships with others?
- Watch a segment of a political debate on YouTube. Would you characterize debates as argumentative, verbally aggressive, or something else entirely? Why?
- John Bowlby's attachment theory and Karen Horney's theory of rejection sensitivity have theoretical overlaps. Do you think that an individual's early attachment can lead to higher levels of rejection sensitivity? Why or why not?

Chapter Wrap-Up

In addition to your personality, your biologically based temperament also plays an important role in how you interact with others interpersonally. As discussed in this chapter, your temperament is identifiable at birth, whereas, your personality is something that develops over your lifespan. Although we cannot change the biological aspects of our temperament, we can learn how to adjust our behaviors in light of our temperaments.

KEY TERMS

- Affectionless Psychopathy
- Affective Orientation
- Anxious Shyness
- Argumentativeness
- Assertiveness
- Authoritarianism
- Cognitive Dispositions
- Communication Apprehension
- Communication Dispositions
- Depression
- Dismissing Attachment
- Dogmatism
- Emotional Intelligence
- Emotional Loneliness
- Empathy
- External Locus of Control
- Extraversion
- Fearful Attachment
- Ideal-Self
- Internal Locus of Control
- Intrapersonal
- Intrapersonal Communication
- Introversion
- Locus of Control
- Loneliness
- Machiavellianism
- Maternal Deprivation Hypothesis
- Narcissism
- Personality
- Preoccupied Attachment
- Rejection Sensitivity
- Relational Dispositions
- Responsiveness
- Right-Wing Authoritarians
- Secure Attachment
- Self-Concept
- Self-Conscious Shyness
- Self-Esteem
- Self-Image
- Self-Monitoring
- Self-Worth
- Shyness
- Social Loneliness
- Social-Personal Dispositions
- Sociocommunicative Orientation
- Temperament
- Verbal Aggression
- Versatility
- Willingness to Communicate

REAL WORLD CASE STUDY

John's mother, Kathleen, was 16 years old when he was born. Kathleen's mother had died during her childbirth because she had refused to get cancer treatments, which could have harmed her unborn child. After Kathleen's birth and her mother's death, Kathleen's father was always cold towards his daughter and often blamed her for his wife's death.

When Kathleen entered her teenage years, she started acting out and started participating in several risky behaviors, which is how she ended up pregnant at 16. After John's birth, Kathleen was simply ill-equipped to handle a child, let alone attempt to bond with a child. During John's first two years of life, he was often dropped at Kathleen's friends' houses or even her grandmother's house, and then Kathleen would disappear

for days. After two years of attempting to raise John, Kathleen's grandmother convinced her to put her child up for adoption.

When John was two, he was adopted by Bobby and Priscilla Wright. The couple already had one child, Mikey, and they desperately wanted another child, but Priscilla was unable to have more children, so the addition of John to their family was very welcome. Although Bobby and Priscilla were amazing parents, John always felt somewhat disconnected.

In school, John rarely kept the same friends as he progressed through his education. He found it easy to leave one set of friends behind and create a new set wherever he went. He often found it very odd when people were still friends with people they'd known since birth. This same pattern of behavior continued into adulthood, and John quickly found himself with a small circle of friends. Honestly, he was horrible at keeping up with his friends. It's not that he didn't like his friends, but he felt that friends needed to fit into his schedule. As time went by, he quickly found himself with more and more acquaintances and fewer and fewer closer relationships. Even his relationship with his family seemed remote and non-essential. He loved his family, but they were almost out of sight, out of mind since they were on the other side of the country.

When John turned 40, he started trying to figure out how his social and relationship life was in such shambles. He wanted to have relationships with other people but simply didn't know how.

1. Based on the information contained in the case, how would you characterize John in this story?
2. Apply John Bowlby's theory of attachment to this story.
3. Apply Karen Horney's theory of rejection sensitivity to this story.

END OF CHAPTER QUIZ

1. Which of the following is NOT one of Charles Horton Cooley's postulates related to the "looking-glass self?"
 - a. Actors learn about themselves in every situation by exercising their imagination to reflect on their social performance.
 - b. Actors next imagine what those others must think of them.
 - c. Actors assess those perceptions through prior interactions with others.
 - d. Actors experience an affective reaction to the imagined evaluation of the

other.

2. Which of the following is the truest statement about the relationship between communication and self-esteem?
 - a. There is no relationship between communication and self-esteem.
 - b. One's self-esteem impacts how he/she/they communicate.
 - c. One's communication impacts an individual's self-esteem.
 - d. There is a circular relationship

between self-esteem and communication.

- c. Fearful
- d. Secure

3. Which of John Daly's personality dispositions refers to general patterns of mental processes that impact how people socially relate to others or view themselves?

- a. Cognitive
- b. Communicative
- c. Relational
- d. Personal-social

4. Jerry is highly in-tune with his emotions. He generally believes that whatever his feelings are telling him to do, it's probably the right thing for him to do. What personality trait is Jerry exhibiting?

- a. Cognitive complexity
- b. Affective orientation
- c. Emotional intelligence
- d. Shyness

5. Which of Kim Bartholomew and Leonard Horowitz's attachment styles describes individuals who see themselves as unworthy of love and generally believe that others will react negatively through either deception or rejection?

- a. Alienated
- b. Dismissing

References

- 1 Kuhn, M. (1960). Sex-attitudes by age, sex, and professional training. *Sociological Quarterly*, 9, 39-55.
- 2 Barker, L. L., & Wiseman, G. (1966). A model of intrapersonal communication. *Journal of Communication*, 16(3), 172-179. <https://doi.org/10.1111/j.1460-2466.1966.tb00031.x>; pg. 173.
- 3 Riccillo, S. C. (1994). Phylogenesis: Understanding the biological origins of intrapersonal communication. In D. R. Vocate (Ed.), *Intrapersonal communication: Different voices, different minds* (pp. 33-56). Lawrence Erlbaum; 35.
- 4 Baumeister, R. F. (1999). *The self in social psychology*. Psychology Press. pg. 247.
- 5 Anderson, N. H. (1968). Likableness ratings of 555 personality-trait words. *Journal of Social Psychology*, 9, 272-279.
- 6 Chandler, J. (2018). Likeableness and meaningfulness ratings of 555 (+487) person-descriptive words. *Journal of Research in Personality*, 72, 50-57. <https://doi.org/10.1016/j.jrp.2016.07.005>
- 7 Rogers, C. (1959). A theory of therapy, personality and interpersonal relationships as developed in the client-centered framework. In S. Koch (Ed.), *Psychology: A study of a science. Vol. 3: Formulations of the person and the social context* (pp. 184-256). McGraw Hill.
- 8 Crocker, J., Luhtanen, R. K., Cooper, M. L., & Bouvrette, A.. (2012). Contingencies of Self-Worth Scale. *Measurement Instrument Database for the Social Science*. Retrieved from http://www.midss.org/sites/default/files/contingencies_of_self-worth_scale.pdf
- 9 Ackerman, C. (2019, May 17). What is self-worth and how do we increase it? *Positive Psychology Program*. Retrieved from <https://positivepsychologyprogram.com/self-worth/>
- 10 Rogers, C. (1959). A theory of therapy, personality and interpersonal relationships as developed in the client-centered framework. In S. Koch (Ed.), *Psychology: A study of a science. Vol. 3: Formulations of the person and the social context* (pp. 184-256). McGraw Hill.
- 11 Cooley, C. H. (1902). *Human nature and the social order*. Scribner's; pg. 184. Retrieved from https://brocku.ca/MeadProject/Cooley/Cooley_1902/Cooley_1902toc.html
- 12 Shaffer, L. S. (2005). From mirror self-recognition to the looking-glass self: Exploring the Justification Hypothesis. *Journal of Clinical Psychology*, 61(1), 47-65. <https://doi.org/10.1002/jclp.20090>
- 13 Pepping, C. A., O'Donovan, A., & Davis, P. J. (2013). The positive effects of mindfulness on self-esteem. *The Journal of Positive Psychology*, 8(5), 376-386. <https://doi.org/10.1080/17439760.2013.807353>
- 14 Ibid.
- 15 Nauman, E. (2014, March 10). Feeling self-critical? Try mindfulness. *Greater Good Magazine*. https://greatergood.berkeley.edu/article/item/feeling_self_critical_try_mindfulness
- 16 Neff, K. (2003). Self-compassion: An alternative conceptualization of a healthy attitude toward oneself. *Self and Identity*, 2(2), 85-101. <https://doi.org/10.1080/15298860309032>
- 17 Ibid pgs. 86-87.
- 18 Ibid; pg. 87.
- 19 Ibid; pg. 89.
- 20 Neff, K., & Germer, C. (2018). *The mindful self-compassion workbook: A proven way to accept yourself, build inner strength, and thrive*. Guilford.
- 21 Neff, K., & Germer, C. (2018). *The mindful self-compassion workbook: A proven way to accept yourself, build inner strength, and thrive*. Guilford; pg. 11.
- 22 Neff, K. (2003). Self-compassion: An alternative conceptualization of a healthy attitude toward oneself. *Self and Identity*, 2(2), 85-101. <https://doi.org/10.1080/15298860309032>; pg. 89.
- 23 Simon, S. B. (1977). *Vulture: A modern allegory on the art of putting oneself down*. Argus Communications.
- 24 Ibid; pgs. 48-49.
- 25 Richmond, V. P., Wrench, J. S., & Gorham, J. (2020). *Communication, affect, and learning in the classroom* (4th ed.). Authors. <http://www.jasonswrench.com/pdf/CommAffect4.pdf>
- 26 Martin, B. (2018). Challenging negative self-talk. *Psych Central*. Retrieved on February 27, 2020, from

<https://psychcentral.com/lib/challenging-negative-self-talk/>

- 27 Daly, J. A. (2002). Personality and interpersonal communication. In M. L. Knapp & J. A. Daly (Eds.), *The SAGE handbook of interpersonal communication* (3rd ed., pp. 133-180). Sage; pg. 144.
- 28 Galton, F. (1875). The history of twins, as a criterion of the relative powers of nature and nurture. *Fraser's Magazine*, 12, 566-576. Retrieved from: <http://galton.org/essays/1870-1879/galton-1875-history-twins.pdf>
- 29 Ibid; pg. 576.
- 30 Bouchard, T. J., Lykken, D. T., McGue, M., Segal, N. L., & Tellegen, A. (1990). Sources of human psychological differences: The Minnesota Study of Twins Reared Apart. *Science*, 250(4978), 223-228. <https://doi.org/10.1126/science.2218526>
- 31 Hoersten, J. (2015, July 28). Reunited after 39 years: A look back at the 'Jim Twins.' *Lima News*. Retrieved from: <https://www.limaohio.com/features/lifestyle/147776/reunited-after-39-years>
- 32 Segal, N. L. (2012). *Born together – Reared apart: The landmark Minnesota Twin Study*. Harvard University Press.
- 33 Bouchard, T. J., Lykken, D. T., McGue, M., Segal, N. L., & Tellegen, A. (1990). Sources of human psychological differences: The Minnesota Study of Twins Reared Apart. *Science*, 250(4978), 223-228. <https://doi.org/10.1126/science.2218526>
- 34 Horvath, C. W. (1995). Biological origins of communicator style. *Communication Quarterly*, 43(4), 394–407. <https://doi.org/10.1080/01463379509369987>
- 35 Norton, R. W. (1978). Foundation of a communicator style construct. *Human Communication Research*, 4(2), 99–112. <https://doi.org/10.1111/j.1468-2958.1978.tb00600.x>
- 36 Beatty, M. J., Heisel, A. D., Hall, A. E., Levine, T. R., & La France, B. H. (2002). What can we learn from the study of twins about genetic and environmental influences on interpersonal affiliation, aggressiveness, and social anxiety? A meta-analytic study. *Communication Monographs*, 69(1), 1-18. <https://doi.org/10.1080/03637750216534>
- 37 Hazel, M., Karst, J., Saezkleriga, G., Wongprasert, T. K., & Ayres, J. (2017). Testing the communibiological paradigm: The similarity of fraternal and identical twins across three communication variables. *Northwest Journal of Communication*, 45(1), 37–51.
- 38 Beatty, M. J., Marshall, L. A., & Rudd, J. E. (2001). A twins study of communicative adaptability: Heritability of individual differences. *Quarterly Journal of Speech*, 87(4), 366–377. <https://doi.org/10.1080/00335630109384346>
- 39 Strelau, J. (1987). Emotion as a key concept in temperament research. *Journal of Research in Personality*, 21, 510-528; pg. 182.
- 40 Keirse, D., & Marilyn, B. (1984). *Please understand me: Character & temperament types* (4th ed.). Prometheus Nemesis.
- 41 Keirse, D. (1998) *Please understand me II*. Prometheus Nemesis.
- 42 Tupes, E. C., & Christal, R. E. (1958). *Stability of personality trait rating factors obtained under diverse conditions*. (Technical Note WADC· TN-58-6L) Personnel Laboratory, Wright Air Development Center: Lackland Air Force Base, TX.
- 43 Tupes, E. C., & Christal, R. E. (1961). *Recurrent personality factors based on trait ratings* (USAF ASD Technical Report No. 61-97). Aeronautical Systems Division, Personnel Laboratory: Lackland Air Force Base, TX. (Reprinted as Tupes, E. C., & Christal, R. E, [1992]. Recurrent personality factors based on trait ratings. *Journal of Personality*, 60, 225-251.)
- 44 McCrae, R. R., & Costa, P. T. (1983). Joint factors in self-reports and ratings: Neuroticism, extraversion and openness to experience. *Personality and Individual Differences*, 4(3), 245–255. [https://doi.org/10.1016/0191-8869\(83\)90146-0](https://doi.org/10.1016/0191-8869(83)90146-0)
- 45 Ibid
- 46 Daly, J. A. (2011). Personality and interpersonal communication. In M. L. Knapp & J. A. Daly (Eds.), *The SAGE handbook of interpersonal communication* (4th ed., pp. 131-167). Sage.
- 47 Ibid pg. 144.

- 48 Burleson, B. R., & Caplan, S. E. (1998). Cognitive complexity. In J. C. McCroskey, J. A. Daly, M. M. Martin, & M. J. Beatty (Eds.), *Communication and personality: Trait perspectives* (pp. 233-286). Hampton Press; pg. 239.
- 49 Wrench, J. S., McCroskey, J. C., & Richmond, V. P. (2008). *Human communication in everyday life: Explanations and applications*. Allyn & Bacon.
- 50 Daly, J. A. (2002). Personality and interpersonal communication. In M. L. Knapp & J. A. Daly (Eds.), *The SAGE handbook of interpersonal communication* (3rd ed., pp. 133-180). Sage; pg. 144.
- 51 Altemeyer, B. (2006). *The Authoritarians*. Winnipeg, Canada, Author; pg. 9.
- 52 Manuel, L. (2006). Relationship of personal authoritarianism with parenting styles. *Psychological Reports*, 98(1), 193-198. <https://doi.org/10.2466/PR0.98.1.193-198>
- 53 Walker, W. D., Rowe, R. C., & Quinsey, V. L. (1993). Authoritarianism and Sexual Aggression. *Journal Of Personality & Social Psychology*, 65(5), 1036-1045.
- 54 Altemeyer, B. (2006). *The Authoritarians*. Winnipeg, Canada, Author.
- 55 Goleman, D. P. (1995). *Emotional intelligence: Why it can matter more than IQ for character, health and lifelong achievement*. Bantam Books.
- 56 Bar-On, R., Parker, J. D. A., & Goleman, D. (2000). *The handbook of emotional intelligence: Theory, development, assessment, and application at home, school and in the workplace*. Jossey-Bass.
- 57 Salovey, P., & Mayer, J. D. (1990). Emotional intelligence. *Imagination, Cognition, and Personality*, 9, 185-211.
- 58 Booth-Butterfield, M., & Booth-Butterfield, S. (1994). The affective orientation to communication: Conceptual and empirical distinctions. *Communication Quarterly*, 42(4), 331-344. <https://doi.org/10.1080/01463379409369941>
- 59 Ibid; pg. 332.
- 60 Booth-Butterfield, M., & Booth-Butterfield, S. (1996). Using your emotions: Improving the measurement of affective orientation. *Communication Research Reports*, 13(2), 157-163. <https://doi.org/10.1080/08824099609362082>
- 61 Ibid; pg. 159.
- 62 Booth-Butterfield, M., & Sidelinger, R. J. (1997). The relationship between parental traits and open family communication: Affective orientation and verbal aggression. *Communication Research Reports*, 14(4), 408-417. <https://doi.org/10.1080/08824099709388684>
- 63 Daly, J. A. (2011). Personality and interpersonal communication. In M. L. Knapp & J. A. Daly (Eds.), *The SAGE handbook of interpersonal communication* (4th ed., pp. 131-167). Sage.
- 64 Anderson, C. A., Miller, R. S., Riger, A. L., Dill, J. C., & Sedikides, C. (1994). Behavioral and chategorlogi-cal attributional styles as predictors of depression and loneliness: Review, refinement, and test. *Journal of Personality and Social Relationships*, 66(3), 549-558.
- 65 Vangelisti, A. L., Knapp, M. L., & Daly, J. A. (1990). Conversational narcissism. *Communication Monographs*, 57(4), 251-274. <https://doi.org/10.1080/03637759009376202>
- 66 Christie, R., & Geis, F. L. (1970). *Studies in Machiavellianism*. Academic Press.
- 67 Snyder, M. (1974). Self-monitoring of expressive behavior. *Journal of Personality and Social Psychology*, 30(4), 526-537. <https://doi.org/10.1037/h0037039>
- 68 Daly, J. A. (2011). Personality and interpersonal communication. In M. L. Knapp & J. A. Daly (Eds.), *The SAGE handbook of interpersonal communication* (4th ed., pp. 131-167). Sage.
- 69 Beatty, M. J., & McCroskey, J. C., & Valencic, K. M. (2001). *The biology of communication: A communibio-logical perspective*. Hampton Press.
- 70 Richmond, V. P., Wrench, J. S., & McCroskey, J. C. (2018). *Scared speechless: Cmmunication apprehension, avoidance, and effectiveness* (7th ed.). Kendall-Hunt.
- 71 Zimbardo, P. G. (1977). *Shyness: What it is, what to do about it*. Addison-Wesley.
- 72 McCroskey, J. C., & Richmond, V. P. (1982). Communication apprehension and shyness: Conceptual and operational distinctions. *Central States Speech Journal*, 33, 458-468.

- 73 Buss, A. (2009). Anxious and self-conscious shyness. In J. A. Daly, J. C. McCroskey, J. Ayers, T. Hopf, D. M. Ayres Sonandre, & T. K. Wongprasert (Eds.), *Avoiding communication: Shyness, reticence, and communication apprehension* (3rd ed., pp. 129-148). Hampton Press.
- 74 McCroskey, J. C. (1977). Classroom consequences of communication apprehension. *Communication Education*, 26(1), 27-33. <https://doi.org/10.1080/03634527709378196>; pg. 28.
- 75 McCroskey, J. C. (1982). *An introduction to rhetorical communication* (4th ed.). Prentice-Hall.
- 76 Richmond, V. P., Wrench, J. S., & McCroskey, J. C. (2018). *Scared speechless: Communication apprehension, avoidance, and effectiveness* (7th ed.). Kendall-Hunt.
- 77 Colby, N., Hopf, T., & Ayres, J. (1993). Nice to meet you? Inter/intrapersonal perceptions of communication apprehension in initial interactions. *Communication Quarterly*, 41(2), 221-230. <https://doi.org/10.1080/01463379309369881>
- 78 McCroskey, J. C., & Richmond, V. P. (1987). Willingness to communicate. In J. C. McCroskey & J. A. Daly (Eds.), *Personality and interpersonal communication* (pp. 129-156). Sage.
- 79 Richmond, V. P., Wrench, J. S., & McCroskey, J. C. (2013). *Communication apprehension, avoidance, and effectiveness* (6th ed.). Allyn & Bacon; pg. 18.
- 80 Infante, D. A., & Wigley, C. J. (1986). Verbal aggressiveness: An interpersonal model and measure. *Communication Monographs*, 53(1), 61-69. <https://doi.org/10.1080/03637758609376126>; pg. 61.
- 81 Kinney, T. A. (1994). An inductively derived typology of verbal aggression and its relationship to distress. *Human Communication Research*, 21(2), 183-222. <https://doi.org/10.1111/j.1468-2958.1994.tb00345.x>
- 82 Infante, D. A., & Rancer, A. S. (1982). A conceptualization and measure of argumentativeness. *Journal of Personality Assessment*, 46(1), 72-80. https://doi.org/10.1207/s15327752jpa4601_13 pg. 72.
- 83 Myers, S. A., & Johnson, A. D. (2003). Verbal aggression and liking in interpersonal relationships. *Communication Research Reports*, 20(1), 90-96. <https://doi.org/10.1080/08824090309388803>
- 84 Martin, M. M., Anderson, C. M., & Horvath, C. L. (1996). Feelings about verbal aggression: Justifications for sending and hurt from receiving verbally aggressive messages. *Communication Research Reports*, 13(1), 19-26. <https://doi.org/10.1080/08824099609362066>
- 85 Semic, B. A., & Canary, D. J. (1997). Trait argumentativeness, verbal aggressiveness, and minimally rational argument: An observational analysis of friendship discussions. *Communication Quarterly*, 45(4), 354-378. <https://doi.org/10.1080/01463379709370071>
- 86 Sandra, B. (1974). The measurement of psychological androgyny. *Journal of Consulting and Clinical Psychology*, 42(2), 155-162. <https://doi.org/10.1037/h0036215>
- 87 Richmond, V. P., & McCroskey, J. C. (1985). *Communication apprehension, avoidance, and effectiveness*. Gorsuch Scarisbrick.
- 88 Richmond, V. P., & McCroskey, J. C. (1990). Reliability and separation of factors on the assertiveness-responsiveness measure. *Psychological Reports*, 67(2), 449-450. <https://doi.org/10.2466/PR0.67.6.449-450>
- 89 Richmond, V. P., & Martin, M. M. (1998). Sociocommunicative style and sociocommunicative orientation. In J. C. McCroskey, J. A. Daly, M. M. Martin, & M. J. Beatty (Eds.), *Communication and personality: Trait perspectives* (pp. 133-148). Hampton Press; pgs. 136-137.
- 90 Richmond, V. P., & Martin, M. M. (1998). Sociocommunicative style and sociocommunicative orientation. In J. C. McCroskey, J. A. Daly, M. M. Martin, & M. J. Beatty (Eds.), *Communication and personality: Trait perspectives* (pp. 133-148). Hampton Press; pg. 136.
- 91 McCroskey, J. C., & Richmond, V. P. (1996). *Fundamentals of human communication: An interpersonal perspective*. Waveland Press.
- 92 Richmond, V. P., & Martin, M. M. (1998). Sociocommunicative style and sociocommunicative orientation. In J. C. McCroskey, J. A. Daly, M. M. Martin, & M. J. Beatty (Eds.), *Communication and personality: Trait perspectives* (pp. 133-148). Hampton Press; pg. 138.
- 93 Patterson, B. R., & Beckett, C. (1995). A re-examination of relational repair and reconciliation: Impact of socio-communicative style on strategy selection. *Communication Research Reports*, 12(2), 235-240. <https://doi.org/10.1080/08824099509362061>

- 94 Daly, J. A. (2011). Personality and interpersonal communication. In M. L. Knapp & J. A. Daly (Eds.), *The SAGE handbook of interpersonal communication* (4th ed., pp. 131-167). Sage.
- 95 Bowlby, J. (1969). *Attachment and loss, Vol. 1: Attachment*. Basic Books.
- Bowlby, J. (1973). *Attachment and loss, Vol. 2: Separation*. Basic Books.
- Bowlby, J. (1980). *Attachment and loss, Vol. 3: Loss, sadness and depression*. Basic Books.
- 96 Bowlby, J. (1969). *Attachment and loss, Vol. 1: Attachment*. Basic Books.
- 97 Bartholomew, K., & Horowitz, L. M. (1991). Attachment styles among young adults: A test of a four-category model. *Journal of Personality & Social Psychology*, 61(2), 226-244. [https://doi.org/ 10.1037/0022-3514.61.2.226](https://doi.org/10.1037/0022-3514.61.2.226)
- 98 Guerrero, L. K., & Burgoon, J. K. (1996). Attachment styles and reactions to nonverbal involvement change in romantic dyads. *Human Communication Research*, 22(3), 335-370. <https://doi.org/10.1111/j.1468-2958.1996.tb00371.x>
- 99 Horney, K. (1937). *The neurotic personality of our time*. W. W. Norton and Company.
- 100 Ibid; pg. 135.
- 101 Ibid; pg. 136.
- 102 Bowlby, J. (1969). *Attachment and loss, Vol. 1: Attachment*. Basic Books.
- Bowlby, J. (1973). *Attachment and loss, Vol. 2: Separation*. Basic Books.
- Bowlby, J. (1980). *Attachment and loss, Vol. 3: Loss, sadness and depression*. Basic Books.
- 103 Downey, G., Freitas, A. L., Michaelis, B., & Khouri, H. (1998). The self-fulfilling prophecy in close relationships: Rejection sensitivity and rejection by romantic partners. *Journal of Personality and Social Psychology*, 75(2), 545-560. <https://doi.org/10.1037/0022-3514.75.2.545>
- 104 Downey, G., & Feldman, S. I. (1996). Implications of rejection sensitivity for intimate relationships. *Journal of Personality and Social Psychology*, 70(6), 1327-1343. <https://doi.org/10.1037/0022-3514.70.6.1327>

END OF CHAPTER QUIZ

ANSWER KEY

- 1) C 2) D 3) D 4) B 5) C





Don't Feed the
VULTURES

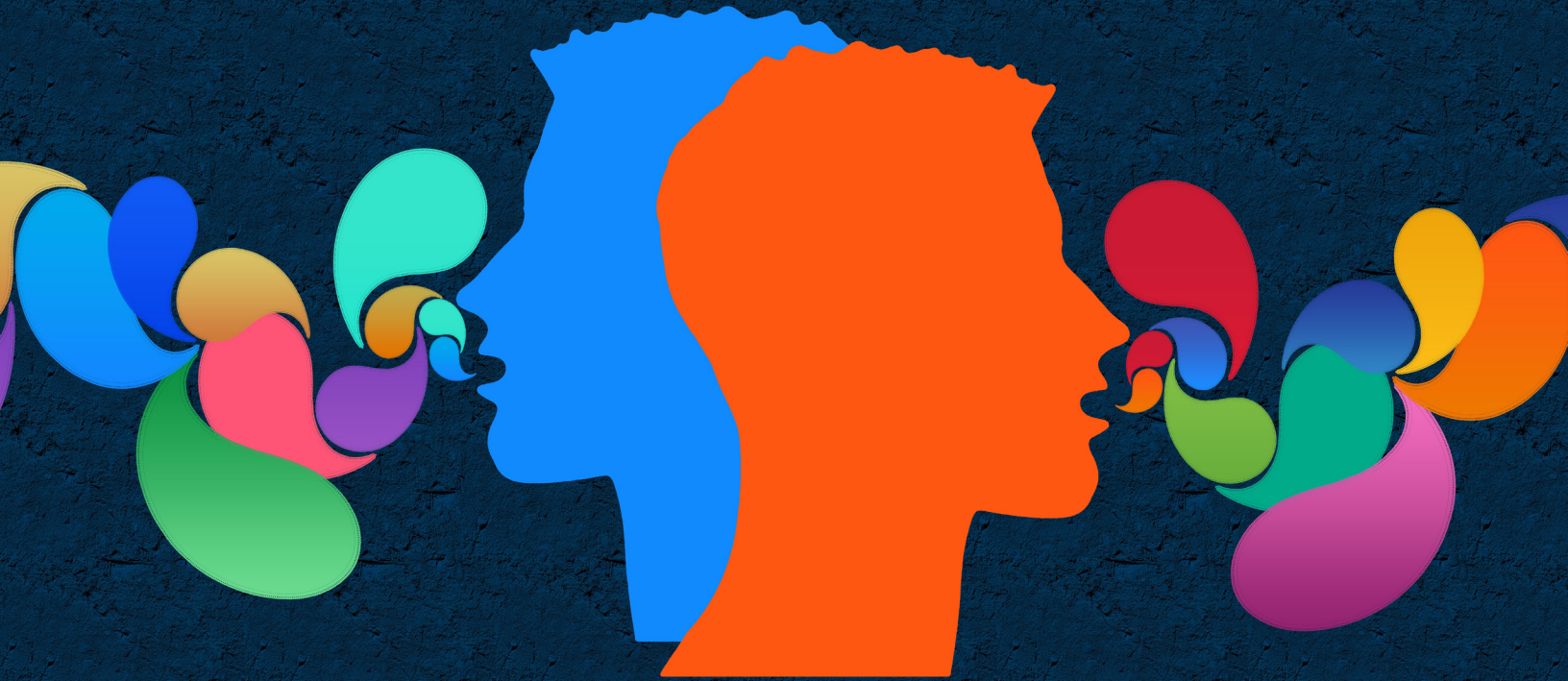

Image by [Gerd Altmann](#) from [Pixabay](#)

Chapter 4

Verbal Elements of Communication

Have you ever said something that someone else misinterpreted as something else? Some of the most common problems in interpersonal communication stem from the use of language. For instance, two students, Kelly and James, are texting each other. Kelly texts James about meeting for dinner, and James texts “K” instead of “okay.” Kelly is worried because she thinks James is mad. She wonders why he texted “K” instead of “k,” “ok,” “yes” or “okay.” James was in a hurry, and he just texted in caps because he was excited to see Kelly.

This example gives us an understanding of how language can influence how our perceptions. Kelly and James had two different perceptions of the same event. One person was worried, and the other person was excited. Chapter 4 examines verbal communication because we know that words are powerful. The words that we use can impact how other people perceive us and how to perceive others.

Language is a system of human communication using a particular form of spoken or written words or other symbols. Language consists of the use of words in a structured way. Language helps us understand others’ wants, needs, and desires. Language can help create connections, but it can also pull us apart.

Language is so vital to communication. Imagine if you never learned a language; how would you be able to function? Without language, how could you develop meaningful connections with others? Language allows us to express ourselves and obtain our goals.

Language is the most important element in human communication. Language is made up of words, which are arbitrary symbols. In this chapter, we will learn about how words work, the functions of language, and how to improve verbal communication.

4.1 How Words Work

LEARNING

OUTCOMES

1. Discover how words have different rules.
2. Determine the level of abstraction.
3. Comprehend the concept of metamessages.

One person might call a shopping cart a buggy, and another person might call it a cart. There are several ways to say you would like a beverage, such as, “liquid refresher,” “soda,” “Coke,” “pop,” “refreshment,” or “drink.” A pacifier for a baby is sometimes called a “paci,” “binkie,” “sookie,” or “mutter button.” Linguist Robin Tolmarch Lakoff asks, “How can something that is physically just puffs of air, a mere stand-in for reality, have the power to change us and our world?”¹ This example illustrates that meanings are in people, and words don’t necessarily represent what they mean.

Words and Meaning

Words can have different rules to help us understand the meaning. There are three rules: semantic, syntactic, and pragmatic.²

Semantic Rules

First, semantic rules are the dictionary definition of the word. However, the meaning can change based on the context in which it is used. For instance, the word fly by itself does not mean anything. It makes more sense if we put the word into a context by saying things like, “There is a fly on the wall;” “I will fly to Dallas tomorrow;” “That girl is so fly;” or “The fly on your pants is open!” We would not be able to communicate with others if we did not have semantic rules.

A cute example of this is about a third-grade teacher who asked about a period. One male student in her class went on and on about how girls have monthly periods, but he did not realize that the teacher meant the use of periods for punctuation at the end of a sentence. Hence, semantic rules need to be understood to avoid embarrassment or misunderstandings.

Syntactic Rules

Second, syntactic rules govern how we help guide the words we use. Syntactic rules can refer to the use of grammar, structure, and punctuation to help effectively convey our ideas. For instance, we can say “Where are you” as opposed to “where you are,” which can convey a different meaning and have dif-

ferent perceptions. The same thing can happen when you don't place a comma in the right place. The comma can make a big difference in how people understand a message.

A great example of how syntactic rules is the *Star Wars* character, Yoda, who often speaks with different rules. He has said, "Named must be your fear before banish it you can" and "Happens to every guy sometimes this does." This example illustrates that syntactic rules can vary based on culture or background.

Another example is Figure 4.1. In this case, we learn the importance that a comma can make in written language. In the first instance, "Let's eat grandma!" is quite different than the second one, "Let's eat, grandma!" The first implies cannibalism and the second a family dinner. As the image says, punctuation saves lives.

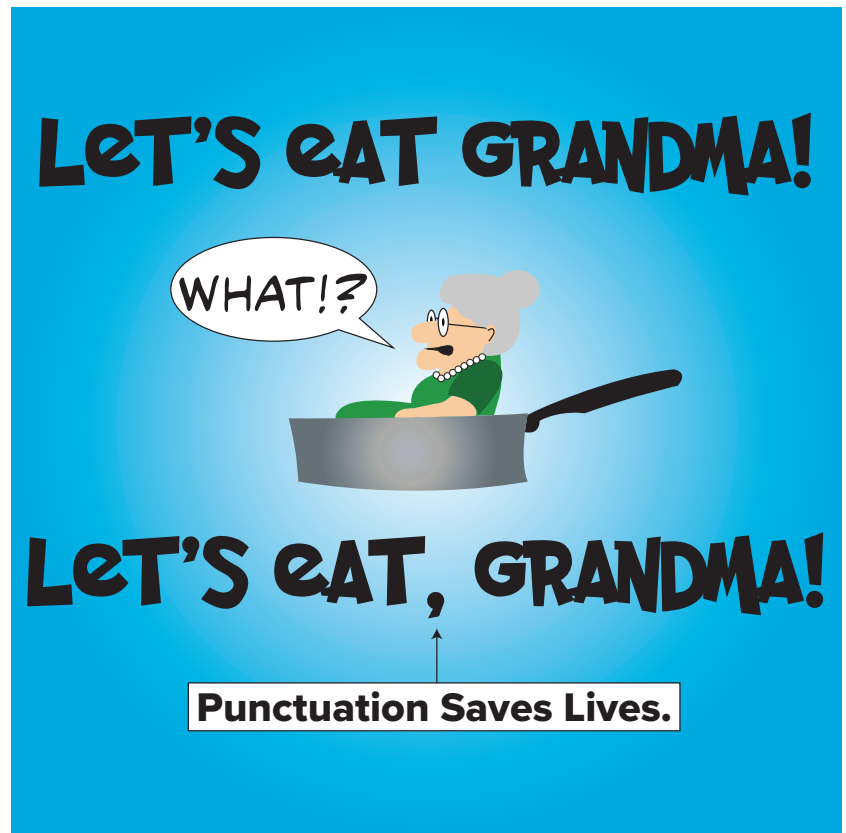

Figure 4.1 Commas Matter

Pragmatic Rules

Third, pragmatic rules help us interpret messages by analyzing the interaction completely. We need to consider the words used, how they are stated, our relationship with the speaker, and the objectives of our communication. For instance, the words "I want to see you now" would mean different things if the speaker was your boss versus your lover. One could be a positive connotation, and another might be a negative one. The same holds true for humor. If we know that the other person understands and appreciates sarcasm, we might be more likely to engage in that behavior and perceive it differently from someone who takes every word literally.

Most pragmatic rules are based on culture and experience. For instance, the term "Netflix and chill" often means that two people will hook up. Imagine someone from a different country who did not know what this meant; they would be shocked if they thought they were going to watch Netflix with the other person and just relax. Another example would be "Want to have a drink?," which usually infers an alcoholic beverage. Another way of saying this might be to say, "Would you like something to drink?" The second sentence does not imply that the drink has to contain alcohol.

It is common for people to text in capital letters when they are angry or excited. You would interpret the text differently if the text was not in capital letters. For instance, "I love you" might be perceived differently from "I LOVE YOU!!!" Thus, when communicating with others, you should also realize that pragmatic rules can impact the message.

Words Create Reality

Language helps to create reality. Often, humans will label their experiences. For instance, the word “success” has different interpretations depending on your perceptions. Success to you might be a certain type of car or a certain amount of income. However, for someone else, success might be the freedom to do what they love or to travel to exotic places. Success might mean something different based on your background or your culture.

Another example might be the word “intimacy.” Intimacy to one person might be something similar to love, but to another person, it might be the psychological connection that you feel to another person. Words can impact a person’s reality of what they believe and feel.

If a child complains that they don’t feel loved, but the parents/guardians argue that they continuously show affection by giving hugs and doing fun shared activities, who would you believe? The child might say that they never heard their parents/guardians say the word love, and hence, they don’t feel love. So, when we argue that words can create a person’s reality, that is what we mean. Specific words can make a difference in how a person will receive the message. That is why certain rhetoricians and politicians will spend hours looking for the right word to capture the true essence of a message. A personal trainer might be careful to use the word “overweight” as opposed to “fat,” because it just sounds drastically different. At Disney world, they call their employees “cast members” rather than workers, because it gives a perception that each person has a part in helping to run the show. Even on a resume, you might select words that set you apart from the other applicants. For instance, if you were a cook, you might say “culinary artist.” It gives the impression that you weren’t just cooking food, you were making masterpieces with food. Words matter, and how they are used will make a difference.

Words Reflect Attitudes

When we first fall in love with someone, we will use positive adjectives to describe that person. However, if you have fallen out of love with that person, you might use negative or neutral words to describe that same person. Words can reflect attitudes. Some people can label one experience as pleasant and another person can have the opposite experience. This difference is because words reflect our attitudes about things. If a person has positive emotions towards another, they might say that that person is funny, mature, and thrifty. However, if the person has negative feelings or attitudes towards that same person, they might describe them as childish, old, and cheap. These words can give a connotation about how the person perceives them.

Level of Abstraction

When we think of language, it can be pretty **abstract**. For example, when we say something is “interesting,” it can be positive or negative. That is what we mean when we say that language is abstract. Language can be very specific. You can tell someone specific things to help them better understand what you are trying to say by using specific and concrete examples. For instance, if you say, “You are a jerk!”, the person who receives that message might get pretty angry and wonder why you said that statement. To be clear, it might be better to say something like, “When you slammed that door in my face this morning, it really upset me, and I didn’t think that behavior was appropriate.” The second statement is more descriptive.

In 1941, linguist S.I. Hayakawa created what is called the **abstraction ladder** (Figure 4.2).³ The abstraction ladder starts abstract at the top, while the bottom rung and is very concrete. In Figure 4.2, we’ve shown how you can go from abstract ideas (e.g., information) through various levels of more

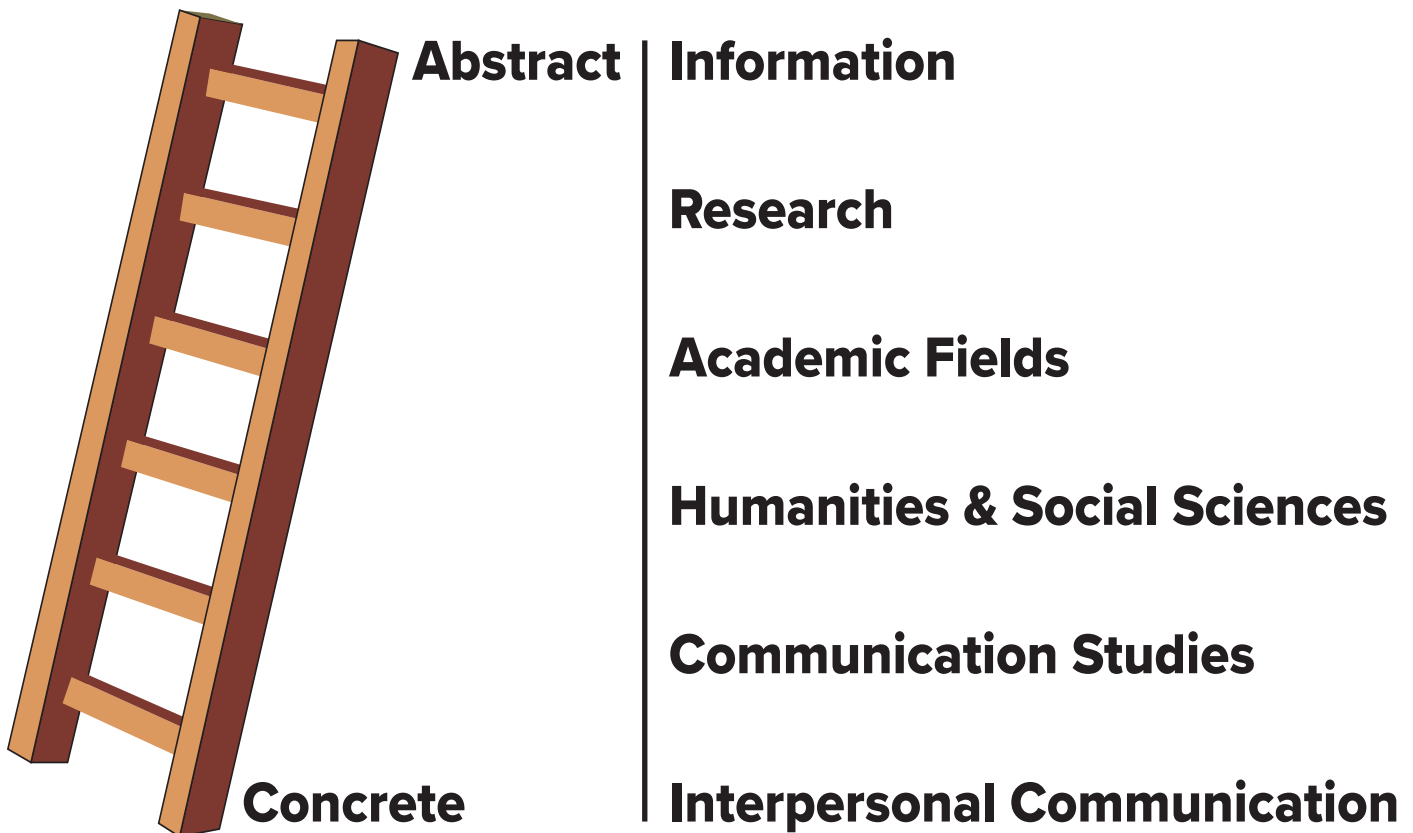

Figure 4.2 Abstraction Ladder

concrete ideas down to the most concrete idea (e.g., interpersonal communication). Ideally, you can see that as we move down the ladder, the topic becomes more fine-tuned and concrete.

In our daily lives, we tend to use high levels of abstraction all the time. For instance, growing up, your

parents/guardians probably helped you with homework, cleaning, cooking, and transporting you from one event to another. Yet, we don't typically say thank you to everything; we might make a general comment, such as a thank you rather than saying, "Thank you so much for helping me with my math homework and helping me figure out how to solve for the volume of spheres." It takes too long to say that, so people tend to be abstract. However, abstraction can cause problems if you don't provide enough description.



Figure 4.3 Perception is Key

Metamessages

Metacommunication is known as communication about communication.⁴ Yet, **metamessages** are relationship messages that are sent among people who they communicate. These messages can be verbal, nonverbal, direct, or indirect. For instance, if you see two friends just talking about what they did last weekend, they are also sending metamessages as they talk. Metamessages can convey affection, appreciation, disgust, ridicule, scorn, or contempt. Every time you send messages to others, notice the metamessages that they might be sending you. Do they seem upset or annoyed with certain things that you say? In this book, we want to stress the importance of mindfulness when speaking. You may not realize what metamessages you are sending out to others.

Words and Meanings

Words can have denotative meanings or connotative meanings. In this section, we will learn about the differences and the triangle of meaning.⁵ Researchers by the names of Ogden and Richards noticed that

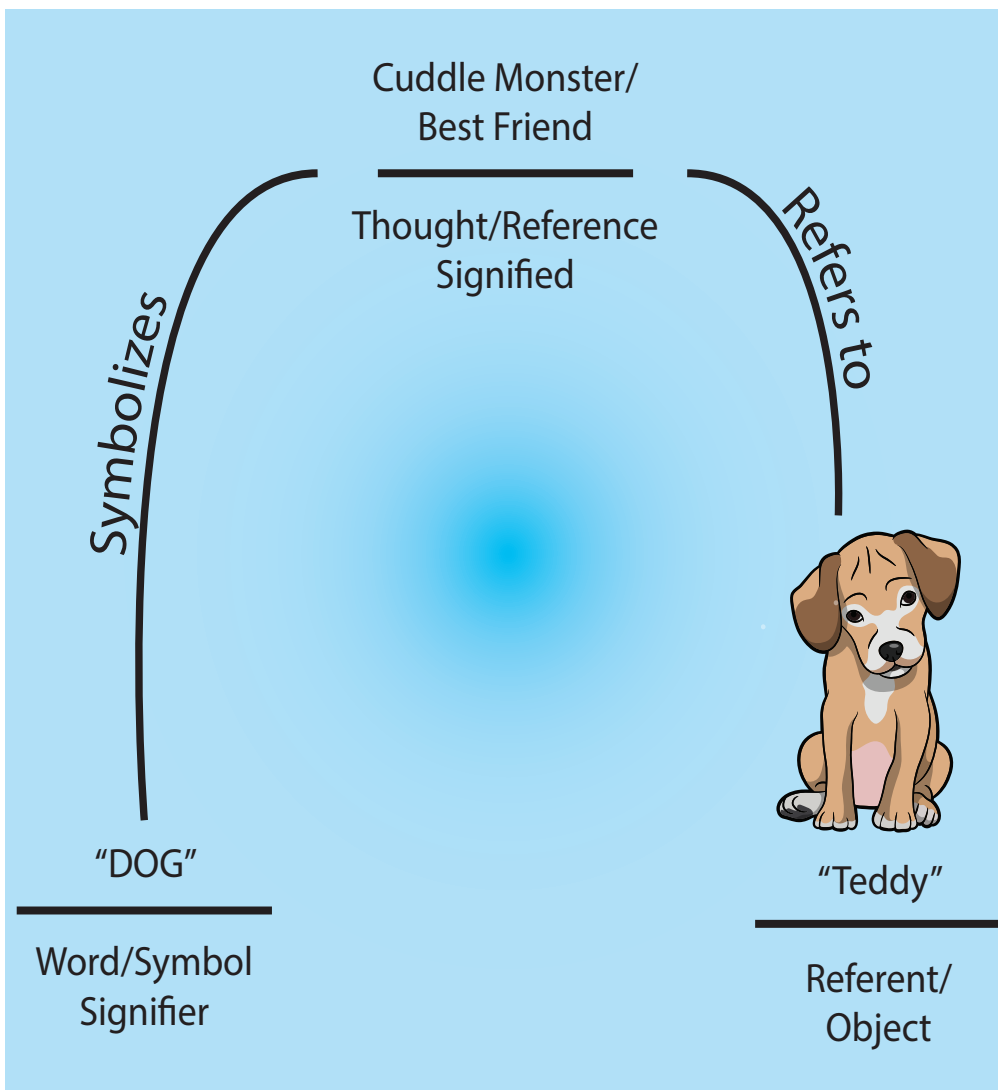

misunderstandings occur when people associate different meanings with the same message. Their model (Figure 4.4) illustrates that there is an indirect association between a word and the actual referent or thing it represents.

As you can see, when you hear the word “dog,” it conjures up meaning for different people. The word “dog” itself is a symbol and signifier, or sound elements or other linguistic symbols that represents an underlying concept or meaning. When we hear the word “dog,” it is what we call the “signified,” or the meaning or idea expressed when someone hears the word. In this case, maybe you have a dog, and you really see that dog as your best friend, or, as in my case, you call him your

Figure 4.4 Signifier, Signified, and Referent

little “cuddle monster” because he always wants to be connected to you at all times. Again, our meaning that we attach to the symbol is still separate from the physical entity itself. In this case, there is a real dog named Teddy, who is the referent, or the physical thing that a word or phrase denotes or stands for.

Words can have a **denotative** meaning, which is the dictionary definition. These are words that most people are familiar with, and they all can agree on the understanding of that word. If you asked a person what a car or a phone is, they would most likely know what you are talking about when you use those words.

Words can have a **connotative** meaning, which is a subjective definition of the word. The word might mean something different from what you meant. For example, you may hear someone referring to their baby. You could fairly safely assume that the person is referring to their infant, but just as easily they could be referring to a significant other.

Key Takeaways

- Words have denotative and connotative meanings. Denotations are the dictionary definition, and connotations are what the words imply.
- Sometimes confusion occurs because people are too abstract in their language. To be clear and concise in language, you need to be descriptive and specific as possible.
- Metamessages involves several meanings and can be conveyed nonverbally and verbally.

Exercises

- Create an example of an abstraction ladder of how communication can range from general to very specific.
- Denotative and Connotative Ability. In groups, find ten random words from the dictionary and ask everyone to write down at least five connotations of each of the words. Then, compare your lists. Discuss the similarities and differences between your word choices.
- Create a metamessages love board. As a class, make a list of all the ways you could tell someone you love them. Then, discuss how your metamessages might cause some misunderstandings or confusion.

4.2 Functions of Language

LEARNING OUTCOMES

1. Distinguish the differences between instrumental and regulatory functions.
2. Appreciate the interactional and imaginative functions of language.
3. Examine the personal, ritual, and cultural functions of language.

Based on research examining how children learn language, it was found that children are trying to create “meaning potential.”⁶ In other words, children learn language so they can understand and be understood by others. As children age, language serves different functions.

Instrumental and Regulatory Functions

Children will typically communicate in a fashion that lets parents/guardians know what they want to do. When children are born, parents/guardians have to figure out if the child is hungry, thirsty, dirty, or sick. Later, when the child acquires language, the child can let the parent/guardian know what they want by using simple words like “eat” or “drink.”

Instrumental functions use language to fulfill a need. In Chapter 2, we learned about Maslow’s Hierarchy of Needs. For us to meet our needs, we need to use language that other people understand.

Language can help us define what we can or cannot do. Often, you might see campaigns that say “Don’t drink and drive” or “Don’t text and drive” to help control behaviors while driving.

Regulatory functions of language are to influence the behaviors of others through requests, rules, or persuasion. These functions do not necessarily coincide with our needs. These might be advertisements that tell us to eat healthier or exercise more using specific products.

Interactional and Imaginative Functions

Interactional functions of language are used to help maintain or develop the relationship. Interactional functions also help to alleviate the interaction. Examples might include “Thank you,” “Please,” or “I care about you.”

Imaginative functions of language help to create imaginary constructs and tell stories. This use of fantasy usually occurs in play or leisure activities. People who roleplay in video games will sometimes engage in imaginative functions to help their character be more effective and persuasive.

Personal Functions

Next, we have **personal functions**, or the use of language to help you form your identity or sense of self. In job interviews, people are asked, “how do you describe yourself?” For some people, this is a challenging question because it showcases what makes you who you are. The words you pick, as opposed to others, can help define who you are.

Perhaps someone told you that you were funny. You never realized that you were funny until that person told you. Because they used the word “funny” as opposed to “silly” or “crazy,” it caused you to

have perceptions about yourself. This example illustrates how words serve as a personal function for us. Personal functions of language are used to express identity, feelings, and options.

Heuristic and Representational Functions

The **heuristic function** of language is used to learn, discover, and explore. The heuristic function could include asking several questions during a lecture or adding commentary to a child's behavior. Another example might be "What is that tractor doing?" or "why is the cat sleeping?"

Representational functions of language are used to request or relay information. These statements are straightforward. They do not seek for an explanation. For instance, "my cat is asleep" or "the kitchen light isn't working."

Cultural Functions

We know a lot about a culture based on the language that the members of the group speak.⁷ Some words exist in other languages, but we do not have them in English. For instance, in China, there are five different words for shame, but in the English language, we only have one word for shame. Anthropologist Franz Boas studied the Inuit people of Baffin Island, Canada, in the late 1800s and noted that they had many different words for "snow." In fact, it's become a myth over the years that the Inuit have 50 different words for snow. In reality, as Laura Kelly points out, there are a number of Inuit languages, so this myth is problematic because it attempts to generalize to all of them.⁸ Instead, the Eskimo-Aleut language tends to have long, complicated words that describe ideas; whereas, in English, we'd have a sentence to say the same thing. As such, the Eskimo-Aleut language probably has 100s of different words that can describe snow.

Analyzing the Hopi Native American language, Edward Sapir and Benjamin Lee Whorf discovered that there is not a difference between nouns and verbs.⁹ To the Hopi people, their language showcases how their world and perceptions of the world are always in constant flux. The Hopi believe that everything is evolving and changing. Their conceptualization of the world is that there is continuous time. As Whorf wrote, "After a long and careful analysis the Hopi language is seen to contain no words, grammatical forms, construction or expressions that refer directly to what we call 'time', or to past, present or future."¹⁰

A very popular theory that helps us understand how culture and language coexist is the Sapir-Whorf hypothesis.¹¹ Edward Sapir and Benjamin Lee Whorf created this hypothesis to help us understand cultural differences in language use. The theory suggests that language impacts perceptions by showing a culture's worldview. The hypothesis is also seen as linguistic determinism, which is the perspective that language influences our thoughts.

Sometimes, language has special rooted characteristics or linguistic relativity. Language can express not only our thoughts but our feelings as well. Language does not only represent things, but also how we feel about things. For instance, in the United States, most houses will have backyards. In Japan, due to limited space, most houses do not have backyards, and thus, it is not represented in their language. To the Japanese, they do not understand the concept of a backyard, and they don't have a word for a backyard. All in all, language helps to describe our world and how we understand our world.

Key Takeaways

- Instrumental functions explain that language can help us accomplish tasks, and regulatory function explains that language can help us control behavior.
- Interactional functions help us maintain information, and imaginative functions allow us to create worlds with others.
- When we talk with others, language can be personal, ritual, or cultural. Personal functions help us identify ourselves. Ritual functions of language involve words that we routinely say to others, such as “hello” or “goodbye.” Cultural functions of language help us describe the worldview or perspectives of culture.

Exercises

- Watch a clip of your favorite TV show and record how many statements are regulatory versus instrumental. Why do you think these differences exist? Do you think it would differ depending on the program? Why?
- Ask several classmates to describe themselves. Then, randomly read a set of descriptions to another classmate and ask them to identify who this person is. Discover if these personal characteristics are viewed by others or not. Determine why these differences might exist.
- Create a list of words that exist in English but are not found in other languages. Then, create a list of words that exist in other languages but not in English. Determine why those words might not exist in English or other cultures.

4.3 The Impact of Language

LEARNING OUTCOMES

1. Understand how naming and identity can influence perceptions.
2. Comprehend how language can impact affiliation with others.
3. Identify the difference between sexist and racist language.

By now, you can see that language influences how we make sense of the world. In this section, we will understand some of the ways that language can impact our perceptions and possibly our behavior. To be effective communicators, we need to realize the different ways that language can be significant and instrumental.

Naming and Identity

New parents/guardians typically spend a great deal of time trying to pick just the right name for their newborn. We know that names can impact other people’s perceptions.¹² Our names impact how we feel and how we behave. For instance, if you heard that someone was named Stacy, you might think that person was female, nice, and friendly, and you would be surprised if that person turned out to be male, mean, and aggressive.

People with unusual names tend to have more emotional distress than those with common names.¹³ Names impact our identity because others will typically have negative perceptions of unusual names or

unique spellings of names. Names can change over time and can gain acceptance. For instance, the name Madison was not even considered a female first name until the movie “Splash” in the 1980s.¹⁴

Some names are very distinctive, which also makes them memorable and recognizable. Think about musical artists or celebrities with unique names. It helps you remember them, and it helps you distinguish that person from others.

Some of the names encompass some cultural or ethnic identity. In the popular book,

Freakonomics, the authors showed a relationship between names and socioeconomic status.¹⁵ They discover that a popular name usually starts with high socioeconomic families, and then it becomes popular with lower socioeconomic families. Hence, it is very conceivable to determine the socioeconomic status of people you associate with based on their birth date and name. Figure 4.5 shows some of the more popular baby names for girls and boys, along with names that are non-binary.

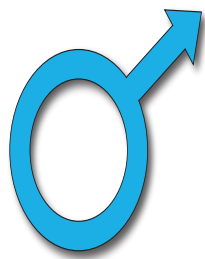

1. Liam
2. Noah
3. William
4. James
5. Oliver
6. Benjamin
7. Elijah
8. Lucas
9. Mason
10. Logan

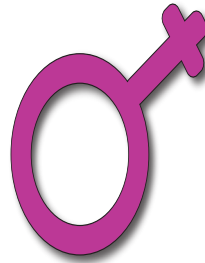

1. Emma
2. Olivia
3. Ava
4. Isabella
5. Sophia
6. Charlotte
7. Mia
8. Amelia
9. Harper
10. Evelyn



1. Sam
2. Alex
3. Emery
4. Corey
5. Ari
6. Cameron
7. Frankie
8. Remi
9. River
10. Skylar (or Skyler)

Figure 4.5 Popular Baby Names

Affiliation

When we want others to associate with us or have an **affiliation** with us, we might change the way we speak and the words we use. All of those things can impact how other people relate to us. Researchers found that when potential romantic partners employed the same word choices regarding pronouns and prepositions, then interest also increased. At the same time, couples that used similar word choices when texting each other significantly increased their relationship duration.¹⁶ This study implies that we often inadvertently mimic other people’s use of language when we focus on what they say.

If you have been in a romantic relationship for a long period, you might create special expressions or jargon for the other person, and that specialized vocabulary can create greater closeness and understanding. The same line of thinking occurs for groups in a gang or persons in the military. If we

adapt to the other person's communication style or **converge**, then we can also impact perceptions of affiliation. Research has shown that people who have similar speech also have more positive feelings for each other.¹⁷ However, speech can also work in the opposite direction when we **diverge**, or when we communicate in a very different fashion. For instance, a group from another culture might speak the same dialect, even though they can speak English, in order to create distance and privacy from others.

Sexism and Racism

Before discussing the concepts of sexism and racism, we must understand the term “bias.” **Bias** is an attitude that is not objective or balanced, prejudiced, or the use of words that intentionally or unintentionally offend people or express an unfair attitude concerning a person's race, ethnicity, sexual orientation, age, disability, or illness. We'll explore more on the issue of biased language later in this chapter.

Sexism or bias against others based on their sex can come across in language. **Sexist language** can be defined as “words, phrases, and expressions that unnecessarily differentiate between females and males or exclude, trivialize, or diminish either sex.”¹⁸ Language can impact how we feel about ourselves and others. For instance, there is a magazine called *Working Mother*, but there is not one called “Working Father.” Even though the reality is that many men who work also have families and are fathers, there are no words that tend to distinguish them from other working men. Whereas, women are distinguished when they both work and are mothers compared to other women who solely work and also compared to women who are solely mothers and/or wives.

Think about how language has changed over the years. We used to have occupations that were highly male-dominated in the workplace and had words to describe them. For instance, policemen, firemen, and chairmen are now police officers, firefighters, and chairpersons. The same can also be said for some female-dominated occupations. For instance, stewardess, secretary, and waitress have been changed to include males and are often called flight attendants, office assistants, and servers. Thus, to eliminate sexism, we need to be cautious of the word choices we use when talking with others. Sexist language will impact perceptions, and people might be swayed about a person's capability based on the word choices.

Similarly, **racism** is the bias people have towards others of a different race. **Racist language** conveys that a racial group is superior or better than another race. Some words in English have racial connotations. Aaron Smith-McLallen, Blair T. Johnson, John Dovidio, and Adam Pearson wrote:

In the United States and many other cultures, the color white often carries more positive connotations than the color black... Terms such as “Black Monday,” “Black Plague”, “black cats” and the “black market” all have negative connotations, and literature, television, and movies have traditionally portrayed heroes in white and villains in black. The empirical work of John E. Williams and others throughout the 1960s demonstrated that these positive and negative associations with the colors black and white, independent of any explicit connection to race, were evident among Black and White children as young as 3 years old ... as well as adults.¹⁹

Currently, there is an ongoing debate in the United States about whether President Trump's use of the phrase “Chinese Virus” when referring to the coronavirus is racially insensitive. The argument for its racial insensitivity is that the President is specifically using the term as an “other” technique to allow his followers to place blame on Chinese people for the coronavirus. Unsurprisingly, as a result of the use of the phrase “Chinese Virus,” there have been numerous violent attacks against individuals of Asian descent within the United States. Notice that we don't say people of Chinese descent here. The people that are

generally inflamed by this rhetoric don't take the time to distinguish among people they label as "other."

It is important to note that many words do not imply any type of sexual or racial connotations. However, some people might use it to make judgments or expectations of others. For example, when describing a bad learning experience, the student might say "Black professor" or "female student" as opposed to just saying the student and professor argued. These descriptors can be problematic and sometimes not even necessary in the conversation. When using those types of words, it can create slight factors of sexism/racism.

Muted Group Theory

Muted group theory was initially developed to explain the way humans, specifically men and women, communicate.²⁰ The theory claims that man-made communication is, just that, "man"-made. Similar to standpoint theory, muted group theory argues that the dominant members of society, typically men, create a language and system of communication that subverts or reduces other groups, specifically women. Muted group theory has been described as feminist theory, and even this nomenclature is a great example of the claims that the theory is making.²¹ The term "feminist" exists in a male-dominated culture and language and connotes a negative conception of that which it is used to describe. Even the fact that there is not a popular term used to describe those who fight for the rights and equal status of men, points to the fact that there is a problem. The word "feminist" exists because it deviates from what is perceived as the "norm." Even the terminology we use to describe women, and a theory that calls attention to their subversion, we see as even more subversion.

Figure 4.6 represents the basic conceptualization of muted group theory. The blue circle represents the dominant group, and the solid arrow points to their perception of reality. Meanwhile, the pink circle represents the muted group, and the dashed line represents their perception of reality. Often what happens in society is that the dominant group's perception of reality is just seen as reality. As such, the muted group's perception of reality is seen as less than or more fanciful than the dominant group's perception. In reality, the muted group often sees things that really do exist in a society that the dominant group either cannot see or chooses not to see based on its position in society as the dominant group.

One area in our society where we can examine muted group theory is about socioeconomic status. Here are just a few statements that wealthy people have made:

- When talking about a couple planning their wedding, "I feel sorry for them, because they have a budget."
- "What do you mean, you don't know if you should get them? Whenever I want new clothes, I

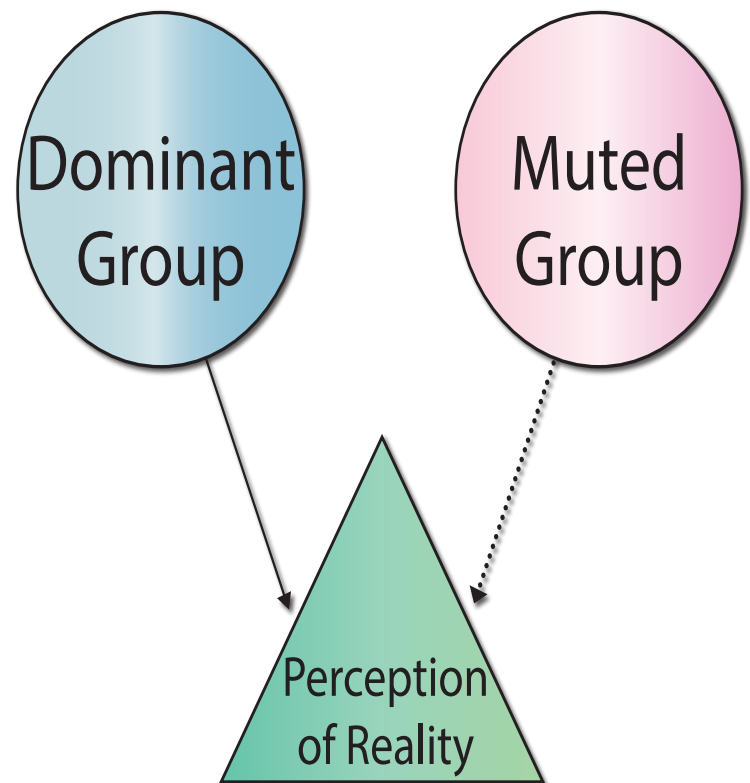

Figure 4.6 Muted Group Theory

just ask my daddy for the money card.”

- The guy was looking on a website for cars, when a rich coworker asks, “why don’t you just buy the car with cash so you don’t have to make payments?” When the guy told his coworker he couldn’t afford to pay for a car in cash, his rich coworker replied, “Why don’t you just have your parents buy it for you?”
- “If you’re making \$50,000 and your salary gets down to \$40,000 and you have to cut, it’s very severe to you. But it’s no less severe to these other people with these big numbers.”
- “People who don’t have money don’t understand the stress. Could you imagine what it’s like to say I got three kids in private school, I have to think about pulling them out? How do you do that?”
- “You don’t get the vote if you don’t pay a dollar in taxes. But what I really think is it should be like a corporation. You pay a million dollars, you get a million votes. How’s that?”

The perspectives illustrated in these statements are ones that most of us cannot easily relate to. The opposite is also true. People who live in the top 1% often have very flawed perceptions of what life is like for those who don’t have piles of money sitting around. Often those in the dominant group (in this case the top 1%) have no conceptualization of what life is like for those in muted groups (the bottom 99%). As such, those in muted groups often have a much clearer perception of reality.

Some research in this theory has been done on other subverted groups such as new kids at school.²² They found that it was normative patterns that created a system of subversion in the classroom. When a new student arrived, they inadvertently went against the popular normative habits of the class and, in doing so, ostracized themselves. Other students simultaneously asserted and solidified their dominance while lowering the status of the new student. This same thing can be seen in our male-dominated society. As women seek to make themselves known and heard, they are continually reduced, and male-centric standards are reinforced.

Research Spotlight



Heather Kissack (2010) focused on the subversion and muting of women in email communication within businesses. She found that women are consistently marginalized and muted in organizational emails in the workplace. This is surprising because it would seem that without the nonverbal cues of face-to-face communication, there would be less muting of women in computer-mediated communication. Unfortunately, in this study, one can see that it is the male-centric verbiage that has created this divide in social and organization status. Even as women attempted to un-mute themselves, they were increasingly muted and subverted.

Kissack, H. (2010). Muted voices: a critical look at e-male in organizations. *Journal of European Industrial Training*, 34(6), 539-551. <https://doi.org/10.1108/03090591011061211>

Key Takeaways

- Names can impact how we perceive others. It can also impact how we feel about ourselves.
- We can increase affiliation with others through converging our language to others.

- We can decrease affiliation with others through diverging our language with others.
- Sexism and racism can be displayed through our language choices. It is important to be aware of the words we use so that we do not come across as sexist or racist.

Exercises

- Create a list of names that you have heard that are unique. What makes these names so unique and memorable? Ask friends to give you their perceptions of those names. Does that match with what you think? Why or why not?
- Engage in a normal conversation with a friend or family member. Without having them know what you are doing, slowly and subtly converge your communication style to theirs. Record your observations. Then, with the same person, try to diverge your communication style. Re-record your observations. Ask if the person noticed any communication changes. How did it make them feel? How did you feel? Why?
- Make a list of all the words in the English language that are sexist or racists. Try to research those words on the Internet and determine how these words are sexist or racists. Then, provide alternatives for these words to be more politically correct.

4.4 Types of Language

LEARNING OUTCOMES

1. Differentiate between informal and formal language.
2. Determine the different types of informal language.
3. Understand improper language and biased language.

If you read or watch different types of programming, you will probably notice that there is a difference in language use based on the environment, who you are talking to, and the reason for communicating. In this section, we will discuss the different types of language. The types of language used will impact how others view you and if they will view you positively or negatively.

Formal vs. Informal Language

You probably know by now that how we communicate in different contexts can vary greatly. For example, how you compose a text to your best friend is going to use different grammatical structures and words than when you compose an email to your professor. One of the main reasons for this difference is because of formal and informal language. Table 4.1 provides a general overview of the major differences between formal and informal language.

Formal Language	Informal Language
Used in carefully edited communication.	Used in impromptu, conversational communication.
Used in academic or official content.	Used in everyday communication.

The sentence structure is long and complicated.	The sentence structure is short, choppy, and improvised.
The emphasis is on grammatical correctness.	The emphasis is on easily understood messages using everyday phrases.
Uses the passive voice.	Uses the active voice.
Often communicated from a detached, third person perspective.	Perspective is less of a problem (1 st , 2 nd or 3 rd).
Speakers/writers avoid the use of contractions.	Speakers/writers can actively include contractions.
Avoid the inclusion of emotionally laden ideas and words.	It allows for the inclusion of emotions and empathy.
Language should be objective.	Language can be subjective.
Language should avoid the use of colloquialisms.	It's perfectly appropriate to use colloquialisms.
Only use an acronym after it has clearly been spelled out once.	People use acronyms without always clearly spelling out what it means.
All sentences should be complete (clear subjects and verbs).	Sentences may be incomplete (lacking a clear subject and/or verb).
The use of pronouns should be avoided.	The use of personal pronouns is common.
Avoids artistic languages as much as possible.	Includes a range of artistic language choices (e.g., alliteration, anaphora, hyperbole, onomatopoeia, etc.).
Arguments are supported by facts and documented research.	Arguments are supported by personal beliefs and opinions.
Language is gender neutral.	Language includes gender references.
Avoids the imperative voice.	Uses the imperative voice.

Table 4.1 Formal vs. Informal Language

Formal Language

When applying for a job, you will most likely use formal language in your cover letter and resume. **Formal language** is official and academic language. You want to appear intelligent and capable, so formal language helps you accomplish those goals. Formal language often occurs when we write. Formal language uses full sentences and is grammatically correct. Formal language is more objective and more complex. Most legal agreements are written in formal language.

Informal Language

Informal language is common, everyday language, which might include slang words. It is continuous and casual. We use informal language when we talk to other people. It is more simple. Informal language tends to use more contractions and abbreviations. If you look at your text messages, you will probably see several examples of informal language.

Jargon

Jargon is the specialized or technical language of a specific group or profession that may not be understood by outsiders.²³ If you are really into cars or computers, you probably know a lot about the different parts and functions. Jargon is normally used in a specific context and may be understood outside that context. Jargon consists of a specific vocabulary that uses words that only certain people understand.

The business world is full of jargon. Joanna Cutrara created a list of 14 commonly heard jargon phrases used in the business world:²⁴

- Low Hanging Fruit
- Leverage
- Open the Kimono
- Giving 110%
- Out of Pocket
- Drink the Kool-Aid
- Bio Break
- Blue Sky Training
- Tiger Team
- Idea Shower or Thought Shower
- Moving the Goal Post
- Drill Down
- Gain Traction

If you're like us, chances are you've heard a few of these jargon phrases in your workplace. Heck, you may have even found yourself using a few of them. Your workplace may even have some specific jargon only used in your organization. Take a minute and think through all of the jargon you hear on an average day.

Colloquialisms

Colloquialisms are the use of informal words in communication.²⁵ Colloquialism varies from region to region. Examples might be “wanna” instead of “want to” or “gonna” instead of “going to.” It shows us how a society uses language in their everyday lives. Here's a short list of some common colloquialisms you may have used yourself:

- Bamboozle - to deceive
- Be blue - to be sad
- Beat around the bush - to avoid a specific topic
- Buzz off - go away
- Fell through the cracks - to be neglected
- Go bananas, or go nuts - go insane or be very angry
- Gobsmacked - shocked
- Gonna - going to
- Hit a writer's block - unable to write
- Hit the hay - to go to sleep
- Pop into my head - to have a new thought
- Sticktoitiveness - to be persistent
- Threw me for a loop - to be surprised
- Throw someone under the bus - to throw the blame on another person
- Wanna - want to
- Y'all - you all
- Yinz - you all

Slang

Slang refers to words that are employed by certain groups, such as young adults and teens.²⁶ Slang is more common when speaking to others rather than written. Slang is often used with people who are similar and have experience with each other. Here is a list of some common slang terms you may use in your day-to-day life:

- BAE (baby / before all else)
- On Fleek (looking perfect)
- Bye Felica (saying goodbye to someone you don't like)
- The Tea (gossip)
- Bro (typically a male friend)
- Cash (money)
- Cheesy (cheap or tacky)
- Ship (wanting people to be in a relationship, whether real or fictional)
- Frenemy (someone who is both a friend and an enemy)
- Thirsty (being overly eager or desperate)
- Throw Shade (to insult another person)
- Woke (being acutely aware of social injustice within society)

How many of these slang words do you use? What other slang words do you find yourself using? When it comes to slang, it's important to understand that this list is constantly evolving. What is common slang today could be completely passé tomorrow. What's common slang in the United States is not universal in English speaking countries.

Idioms

Idioms are expressions or figures of speech whose meaning cannot be understood by looking at the individual words and interpreting them literally.²⁷ Idioms can help amplify messages. Idioms can be used to provide artistic expression. For instance, "knowledge is power!"

Idioms can be hard to grasp for non-native speakers. As such, many instructors in the English as a Second Language world spend a good deal of time trying to explain idioms to non-native speakers. Table 4.2 presents a wide array of different idioms.

ish	About. I'll meet you at 4ish.
a basket case	A wreck. He was a basket case after he was thrown off the basketball team.
a breath of fresh air	Refreshing/fun. She's a breath of fresh air.
a change of heart	Change my mind. I've had a change of heart.
a blessing in disguise	Something bad that turns out good. Losing his job turned out to be a blessing in disguise.
a dead end	That's a dead end job—time to find a new one.
a gut feeling	Feeling in my stomach. I have a gut feeling that everything is going to turn out all right.
a matter of opinion	It's a matter of opinion whether eating fried tarantulas is a gourmet treat.
a piece of cake	That test was a snap—it was a piece of cake. (easy).
a ripoff	You spent \$500 for a watermelon! What a ripoff! You were cheated.
a pain in the neck	A pest. His little brother is a real pain in the neck.

be in hot water	Be in trouble. If you tell your boss off, you'll really be in hot water.
in the same boat	We're in the same situation. We're all in the same boat-so be cool.
on the same wavelength	We have the same ideas and opinions. We're on the same wavelength.
be on the ball	Very sharp. Very smart. He's really on the ball.
it's only a matter of time	Very soon. It's only a matter of time until his boss realizes that he is the one stealing money from the till.
be that as it may	As things stand. Be that as it may, I think you should reconsider your decision to move to Antarctica.
up in arms	Really angry. His father was up in arms when he learned that he had crashed his new car.
up in the air	Not sure. Plans are up in the air-we haven't decided what to do yet.
bend over backwards	Go out of your way. She really bent over backwards to make my stay enjoyable.
Big deal!	Not important (sarcastic). Losing an old sock is not a big deal.
cost an arm and a leg	Very expensive. His new Ferrari cost an arm and a leg.
cross your fingers	For good luck. Cross your fingers that I pass the English exam with flying colors.
draw a blank	I can't remember. I drew a blank when I tried to remember his brother's name.
Easier said than done	More difficult than it seems.
Am fed up with	Sick and tired of something. I'm fed up with whining friends who have everything!
from scratch	Make from basic ingredients. Her carrot cake was made from scratch.
for the time being	For now. For the time being, everything is fine at work.
get cold feet	Feel too scared to do something. John wanted to ask Maria out but he got cold feet and decided not to.
get out of the wrong side of the bed	In a bad mood. He must have gotten up out of the wrong side of the bed today.
get the picture	Understand. Do you get the picture?
get your act together	Get organized/stop wasting time. You better get your act together or you're going to fail all your classes.
give it a shot	Try. Why not try bungee jumping. Give it a shot.
give him a piece of your mind	Get angry and tell someone off. If I were you I would give him a piece of your mind.
give him the cold shoulder	Ignore someone. Brett walked right past me without saying a word. He gave me the cold shoulder.
go all out	Do your utmost for someone or something. His parents went all out for his graduation party.
go downhill	Get worse. After he got divorced, everything went downhill.
go up in smoke	Evaporate/disappear. His dreams of being a professional athlete went up in smoke when he broke his leg.
have a chip on your shoulder	I think you are great. He has such a chip on his shoulder that he hardly ever relates to anyone.
had it up to here	Can't take any more. I've had it up to here with noisy students!
mixed feelings	Positive and negative feelings together. I have very mixed feelings about her marrying a fisherman.
second thoughts	Thinking again about a decision. I'm having second thoughts about trekking in Greenland this summer.
throw a fit	Get really angry. His mother threw a fit when she heard that he lost her iPhone.
I'm all ears	To listen intently. Tell me about your wedding plans-I'm all ears.

in the bag	Certain. His new job is in the bag. He signed the contract.
in the middle of nowhere	Way out in the country. Their ski chalet is in the middle of nowhere.
Just my luck!	Bad luck. Just my luck to lose the winning lottery ticket.
keep an eye on	Watch carefully. Will you keep an eye on my nephew while I walk the dog?
bear in mind	Keep it in mind. Bear in mind, learning a new language isn't as easy as it seems.
learn by heart	Memorize. You have to learn irregular verbs by heart.
let the cat out of the bag	Spill the beans. Tell a secret. Don't let the cat out of the bag. Keep his surprise birthday party a secret.
make my day	Make my day great. The guy I have a crush on finally called me. He made my day.
miss the point	Don't understand the basic meaning. You are missing the point entirely.-.
no way	Impossible. You got all A's on your exams and you never studied. No way!
don't have a clue	I have no idea. I don't have a clue what the professor was talking about.
don't have the faintest idea	Don't understand. I don't have the faintest idea of what that article was talking about.
off the top of my head	Without thinking. Off the top of my head, I think it's worth \$6 million.
on the dot	Ontime. He arrived at 6 o'clock on the dot.
out of sight, out of mind	You forget someone you don't see anymore.
out of the blue	Suddenly. Guess who called me out of the blue?
play it by ear	Make no plans—do things spontaneously. Let's just play it by ear tonight and see what comes up.
pull someone's leg	Kid someone. Stop pulling my leg. I know you are kidding!
red tape	Bureaucracy. It's almost impossible to set up a business in Greece because there is so much red tape.
read between the lines	Understand what is not stated. If you read between the lines, you'll realize that he is trying to dump you.
safe and sound	Fine. The Boy Scouts returned safe and sound from their camping adventure in Yellowstone National Park.
see eye to eye	Agree. He doesn't see eye to eye with his parents at all.
sour grapes	Pretend to not want something that you are desperate for. It's just sour grapes that he is criticizing George's villa in Italy.
slipped my mind	Forgot. I meant to call you last night, but it slipped my mind.
small talk	Chitchat. It's important to be able to make small talk when you meet new people for the first time.
talk shop	Talk about work. What a boring evening! Everyone talked shop- and they're all dog walkers!
the icing on the cake	Something that makes a good thing great. And the icing on the cake was that the movie for which he earned \$12 million, also won the Oscar for best picture.
the last straw	The thing that ruins everything. When my boss asked me to cancel my wedding to complete a project—I said that's the last straw and I quit!
time flies	Time goes fast. Time flies when you are having fun.
you can say that again	You agree emphatically. Kanye West is a great singer. You can say that again!
you name it	Everything you can think of. This camp has every activity you can think it—like swimming, canoeing, basketball and you name it.
wouldn't be caught dead	Not even dead would I do something. I wouldn't be caught dead wearing that dress to the ball.

she's a doll	Someone really great. Thanks for helping me out. You're a doll.
full of beans	Lively-usually for a child. Little children are usually full of beans.
full of baloney	Not true. She's full of baloney-she doesn't know what she is talking about.
like two peas in a pod	Very similar. His two brothers are like peas in a pod.
a piece of cake	Very easy. My math test was so easy-a real piece of cake.
sounds fishy	Suspicious. Doubling your money in an hour sounds fishy to me.
a frog in my throat	I can't speak clearly. Ahem! Sorry I had a frog in my throat.
smell a rat	Something is suspicious. The policeman didn't believe the witness-in fact, he smelled a rat.
go to the dogs	Go downhill. Everything is going to the dogs in our town since the new mayor took office.
cat got your tongue	Silent for no reason. What's the matter? Cat got your tongue?
for the birds	Awful. How was the new Batman movie? Oh, it was for the birds.
pay through the nose	Pay lots of money. They paid through the nose to hold their wedding at Buckingham Palace.
tongue in cheek	Being ironic. I meant that tongue in cheek. I was kidding.
all thumbs	Clumsy. He couldn't put that simple table together-he's just all thumbs.
get off my back	Leave me alone. Bug off! Get off my back!
drive me up a wall	Drive me crazy. Rude people drive me up a wall.
spill the beans	Tell a secret. Hey, don't spill the beans. It's a secret.
hit the ceiling	Blow up. His dad hit the ceiling when he saw his dreadful report card.
go fly a kite	Get lost! Oh, leave me alone! Go fly a kite!
dressed to kill	Dressed in fancy clothes. Cinderella was dressed to kill when she arrived at the ball.
in stitches	Laughing a lot. We were all in stitches when we heard the latest joke.
feel like a million dollars	Feel great. I just slept for 15 hours-I feel like a million dollars.
at the end of my rope	Can't stand it anymore. The mother of four little children is at the end of her rope.
my head is killing me	Something hurts. My head is killing me-I should take an aspirin.
that's out of the question	Impossible. Me? Stand up and sing and dance in front of the whole school-out of the question!
I'm beat	Very tired.
It'll knock your socks off!	Thrills you. You'll love this summer's action movie. It'll knock your socks off.
beats me	Don't know. What's the capital of Outer Mongolia? Beats me!
hands down	No comparison. Hands down Mykonos is the world's most beautiful island.
goody-goody	Behaves perfectly. I can't stand Matilda-she's such a goody-goody and no fun at all.
pain in the neck	A big problem. Washing dishes is a pain in the neck.
like pulling teeth	Very difficult. Trying to get 2-year-olds to cooperate is like pulling teeth.
for crying out loud	Oh no! For crying out loud-let me finish this book-will you?
I'm at my wit's end	I'm desperate. I'm at my wit's end trying to deal with two impossible bosses.
like beating a dead horse	A waste of time. Trying to get my father to ever change his mind is like beating a dead horse.
out of this world	Fantastic! My vacation to Hawaii was out of this world!
cost an arm and a leg	Very expensive. A Rolls Royce costs an arm and a leg.

go figure	Try to guess why. Our English teacher gives us five tests a week and this week—no tests at all. Go figure.
in the nick of time	Just in time. The hero arrived in the nick of time to save the desperate damsel.
I'm up to my eyeballs in	Very busy. I'm up to my eyeballs in work this week.
I had a blast/a ball	A great time. I had a blast/ball at Sandy's slumber party.
win-win situation	Both sides win. Selling their old stock of iPhones 10s was a win-win situation. They got rid of the useless phones, and we bought them really cheaply.
I'm swamped	Very busy. Let's get together next week—this week I'm swamped.
It's a steal	Fantastic bargain. Getting a new computer for \$300 dollars is a steal.
the sticks	Way out in the country. Who would want to live in the sticks—what would you do for excitement?
break the ice	Start a conversation. Talking about the weather is a good way to break the ice when you meet someone new.
give me a break	Leave me alone! Come on! Give me a break! I've been working all day long—and I just want to play a little bit of Angry Birds....
like talking to the wall	A waste of time. Dealing with many teenagers is like talking to a wall—they won't even respond to your questions.
see eye to eye	Agree. I hardly ever see eye to eye with my parents.
It's about time	It's time. It's about time you started your homework—it's midnight!
pays peanuts	Pays hardly anything. This job pays peanuts—\$1 an hour!.
sleep like a log	Sleep soundly. Last night I slept like a log and didn't hear the thunderstorm at all.
ace	Do great. I aced the math test. I got 100%.
easy as pie	Super easy. The English test was as easy as pie.
blabbermouth	Someone who tells secrets. Don't tell Sophie your secrets or the whole town will know them.
don't bug me	Don't bother me. Don't bug me—I'm busy.
by the skin of my teeth	Barely manage something. I passed the geography test by the skin of my teeth.
can't make head nor tail of	I can't understand. I can't make head nor tail of this math chapter.
cool as a cucumber	Very calm. The policeman was cool as a cucumber when he persuaded the man not to jump off the Brooklyn Bridge.

Reused here from [Kifissia](#) under a Creative Commons Attribution License.

<https://tinyurl.com/rtxklo5>

Table 4.2 Common Idioms

Clichés

Cliché is an idea or expression that has been so overused that it has lost its original meaning.²⁸ Clichés are common and can often be heard. For instance, “light as a feather” or “happily ever after” are common clichés. They are important because they express ideas and thoughts that are popular in everyday use. They are prevalent in advertisements, television, and literature.

Improper Language

Improper language is not proper, correct, or applicable in certain situations.²⁹ There are two different

types of improper language: vulgarity and cursing. First, vulgarity includes language that is offensive or lacks good taste. Often, vulgar is lewd or obscene. Second, cursing is language that includes evil, doom, misfortune on a person or group. It can also include curse or profane words. People might differ in their perceptions about improper language.

Biased Language

Biased language is language that shows preference in favor of or against a certain point-of-view, shows prejudice, or is demeaning to others.³⁰ Bias in language is uneven or unbalanced. Examples of this may include “mankind” as opposed to “humanity.”

Avoid	Consider Using
Black Attorney	Attorney
Businessman	Businessperson, Business Owner, Executive, Leader, Manager, etc.
Chairman	Chair or Chairperson
Cleaning Lady / Maid	Cleaner, Cleaning Person, Housecleaner, Housekeeper, Maintenance Worker, Office Cleaner, etc.
Male Nurse	Nurse
Male Flight Attendant or Stewardess	Flight Attendant
Female Doctor	Physician or Doctor
Manpower	Personnel or Staff
Congressman	Legislator, Member of Congress, or Member of the House of Representatives
Postman	Postal Employee or Letter carrier
Forefather	Ancestor
Policeman	Police Officer / Law Enforcement Officer
Fireman	Firefighter
Disabled	People with Disabilities
Schizophrenic	Person Diagnosed with Schizophrenia
Homosexual	Lesbians, Gay Men, Bisexual Men or Women

Table 4.3 Biased Language

One specific type of biased language is called spin, or the manipulation of language to achieve the most positive interpretation of words, to gain political advantage, or to deceive others. In essence, people utilizing spin can make language choices that frame themselves or their clients in a positive way.

Ambiguous Language

Ambiguous language is language that can have various meanings. Google Jay Leno’s headlines videos. Sometimes he uses advertisements that are very abstract. For instance, there is a restaurant ad that says, “People are our best ingredient!” What comes to mind when you hear that? Are they actually using people in their food? Or do they mean their customer service is what makes their restaurant notable? When we are trying to communicate with others, it is important that we are clear in our language. We

need others to know exactly what we mean and not imply meaning. That is why you need to make sure that you don't use ambiguous language.

Euphemisms

Euphemisms also make language unclear. People use euphemisms as a means of saying something more politely or less bluntly. For instance, instead of telling your parents/guardians that you failed a test, you might say that you did sub-optimal. People use euphemisms because it sounds better, and it seems like a better way to express how they feel. People use euphemisms all the time. For instance, instead of saying this person died, they might say the person passed away. Instead of saying that someone farted, you might say someone passed gas.

Relative Language

Relative language depends on the person communicating. People's backgrounds vary. Hence, their perspectives will vary. I know a college professor that complains about her salary. However, other college professors would love to have a salary like hers. In other words, our language is based on our perception of our experiences. For instance, if someone asked you what would be your ideal salary, would it be based on your previous salary? Your parents? Your friends? Language is relative because of that reason. If I said, "Let's go eat at an expensive restaurant," what would be expensive for you? For some person, it would be \$50, for another, \$20, for someone else it might be \$10, and yet there might be someone who would say \$5 is expensive!

Static Evaluation

Often times, we think that people and things do not change, but they do change. If you ever watch afternoon talk shows, you might see people who go through amazing transformations, perhaps through weight loss, a makeover, or surgery or some sort. These people changed. **Static evaluation** states that things are not constant. Things vary over time, and our language should be representative of that change. For instance, Max is bad. It is important to note that Max might be bad at one time or may have displayed bad behavior, but it may not represent how Max will be in the future.

MINDFULNESS ACTIVITY



For the entire day, we want you to take a minute to pause before you text or email someone. When we text or email someone, we typically just put our thoughts together in a quick fashion. Take a second to decide how you plan to use your words. Think about which words would be best to get our message across effectively. After you have typed your message, take another few minutes to reread the message. Be mindful of how others might interpret your message. Would they read it at face value, or would they misinterpret the message because there is a lack of nonverbal messages? Do you need to add emojis or GIFS to change how the message is conveyed?

Researchers have found that when college students can address their emotions and are mindful of their feelings, it can enhance written communication with others.³¹ After

doing this activity, try to be more mindful of the things that you send to other people.

Key Takeaways

- Formal language is more careful and more mannered than everyday speech, whereas informal language is appropriate in casual conversation.
- Informal language includes (1) Jargon, or technical language; (2) Colloquialism, or informal expressions; (3) Slang, or nonstandard language; (4) Idioms, or expressions or figures of speech; (5) clichés, or sayings that are overused and predictable.

Exercises

- Create a list of jargon or slang words that you use and what they mean. Determine if there are differences between how words are used now compared to the past.
- Create a list of colloquialisms or idioms. Find an international student and see if these words make sense. What was confusing or unclear?
- Find clichés that are used in other cultures. Determine if you can find an American equivalent of each cliché.

4.5 Improving Verbal Communication

LEARNING OUTCOMES

1. Examine ways to improve your vocabulary.
2. Increase your awareness and adaptation of language.
3. Realize the importance of checking for understanding.

In this chapter, you have learned the importance of language. In this last section, we will discuss ways to improve your verbal communication skills. To be a great interpersonal communicator, it is extremely important that you also know how to use language in the most effective way.

Improving Language Skills

From an early age, you probably had words that you used most frequently because you were familiar with those words. As you get older and become more educated, your vocabulary has probably expanded to help you become more successful. Language is used to help express our feelings, intentions, and comprehension of others.³² An extensive vocabulary is a keen predictor of someone's social status, education, and profession. Whether you like it or not, the words we use and the grammatical structure of how we use those words can impact our standing in school, work, and society. Here are some tips to help you improve your vocabulary.

Use Repetition

First, be sure to use repetition. To become familiar with a word, you need to see it over and over again. Besides, you need to use it in conversations over and over again. The more times you repeat the word, the more likely you will memorize it, and it will become part of your daily repertoire.

Group Similar Words Together

Second, group similar words together. You should never learn vocabulary by looking at a list of words. Think of words as different pieces of a jigsaw puzzle. It doesn't make sense to look at each piece of the puzzle individually. Rather, you need to fit them together to see the whole picture. The same thing should occur with words. You should memorize words that have similarities in some way. For instance, create a vocabulary around a theme, such as music, or an adjective, such as beautiful.

Build Your Vocabulary

Third, it is essential to make vocabulary that is personal to you. **Vocabulary** can be defined as all the words understood by a person or group of people. As early as four months, a baby can start to distinguish between language sounds and other sounds. According to David Crystal, language acquisition happens quite rapidly:

- By age 2, people can recognize and speak 200 words.
- By age 3, people can recognize and speak about 2000 words.
- By age 5, people can recognize and speak about 4,000 words.³³

That means your average infant to toddler is learning three to four new words every day. Infants are hardwired to learn a language. If you want to ensure your child can speak multiple languages, it's best to expose them to multiple languages during this crucial developmental cycle. Even though we start as infants, we continue to improve our vocabularies right through middle age:

- Most adult native test-takers range from 20,000–35,000 words
- Average native test-takers of age 8 already know 10,000 words
- Average native test-takers of age 4 already know 5,000 words
- Adult native test-takers learn almost 1 new word a day until middle age
- Adult test-taker vocabulary growth basically stops at middle age³⁴

As you can see, most native English-speaking adults have fairly substantial vocabularies, but we do see a drop in new language acquisition as people enter into their middle age. As such, it's important to keep learning.

One way to keep learning is to find words that have meaning for you. If you have ever heard a story about survival from someone who has gone through something life-changing, they probably used words that touched you and helped you to connect to the story. In the same fashion, you should find words that can relate to your story. When we find words that have personal meaning to us, we can use those words more effectively in our own vocabulary. Here are some essential tips for building your vocabulary:

1. Keep a journal of words you don't know.
2. If you don't know a word, look it up in a dictionary.
3. Learn to recognize both Latin and Greek roots of words.
4. Play vocabulary games (e.g., anagrams, Boggle, crossword puzzles, scrabble).
5. Make synonym and antonym word lists.
6. Take a writing and/or editing course.

Read

Lastly, you should read regularly. It doesn't matter what you read. As long as you are reading, you will probably come across words that you are unfamiliar with. When you do come across a word you don't know, take the time to look it up. This practice is especially important when reading academic works because they are often full of ten-thousand-dollar words. Next time you read and run across a word that you don't know, be sure to find the definition so that you can comprehend what is being said.

We would also recommend reading articles and books that stretch you. Don't just read books like the *Twilight* and *Harry Potter* because those are written on a junior high or middle-school reading level.

Increase Your Awareness and Adaptation of Language

After learning to improve your vocabulary, it's also important to increase language awareness and adaptation. When we talk about **language awareness**, we are referring to a person's ability to be mindful and sensitive to all functions and forms of language.³⁵ For our purposes, we define **language adaptation** as the ability to alter one's linguistic choices in a communicatively competent manner. As such, it's not just about being aware of language that leads to effective interpersonal interactions, but our ability to adapt our linguistic choices with different people to maximize the effectiveness of our interpersonal communication.

There are a couple of ways that people can increase their language awareness and adaptation. The first way is to engage in meaningful interpersonal communication with someone different from you. This person can be from a different country or different region of the country from you. When you speak to someone very different from you, you might notice how they use language differently or how they prefer certain words over others.

Another way might be to watch a foreign film. Check out different international films that have been nominated for an Academy Award. Most of them will be dubbed in English or have English subtitles. Pay attention to how the characters communicate with each other to create meaning. Does it give you an appreciation for how you speak?

Lastly, spend some time with a small child, preferably under the age of five. Pay attention to how the child communicates with you versus others (e.g., their friends, parents/guardians, siblings). Children under five are still acquiring words and learning to talk. When you communicate with someone who has a very limited vocabulary, it might help you see how you can adapt your language so that they will understand you.

Check for Understanding

As a speaker, you want to know that the receiver of your message understood what you said. This concept is also known as checking for understanding or verifying what has been said is also understood.³⁶ Even if a person is smiling and nodding at you when you talk, it does not necessarily mean that they are paying attention to everything. They might be trying to be polite and/or friendly. The best way to check for understanding is to use the acronym: TAP. Think of communication like a tap dance; if you don't hear any tapping, would it really be a tap dance? The same thing can be applied to communication. Did you communicate if the other person didn't understand you or get what you were trying to say?

First, the T in TAP means to talk first. In other words, you explicitly present all the content. As you are talking, you are also trying to make sure that the other person is listening to you talk.

Second, the A in TAP stands for ask questions. After you talked to the person, try to ask specific

questions. Rather than saying, “did you hear me?” or “were you listening, which are both yes/no questions, it would be more beneficial to ask, “what did I just say?” or “what did you hear me say?”

Third, the **P** in **TAP** means to be prepared to listen. Listen carefully to what the other person says. It is during this phase that you can see if they understood your message. Was the message correct? What emotions are they displaying after you said the message and asked questions? If we don’t ask questions, then we can’t be sure that the message was received effectively.

Key Takeaways

- The first part of this section provided several different ways to help you improve vocabulary (e.g., use repetition, group like words together, build your vocabulary, and read).
- Further and increase awareness (a person’s ability to be mindful and sensitive to all functions and forms of language) and adaptation of language (the ability to alter one’s linguistic choices in a communicatively competent manner).
- It’s important to remember the three basic steps to ensure understanding: **T** (talk first), **A** (ask questions), and **P** (prepare to listen).

Exercises

- Go through the various key terms within this chapter. Did you know all of the definitions before reading this chapter? Which terms did you find difficult to understand? Why?
- Read a speech from either Vital Speeches of the Day or American Rhetoric. After reading/watching a speech, find a video where the speaker was interviewed. Watch how the speaker sounds when both giving a speech and when answering questions. Analyze the speaker’s use of both language awareness and adaptation.
- Find someone who does not speak English as their first language. During your interaction with that person, put into practice the **TAP** Method for understanding. How easy was it for you to understand this other person? Why? How did it feel to use the **TAP** method? Were you effective during your interpersonal interaction? Why?

Chapter Wrap-Up

In this chapter, we discussed the importance of verbal communication. To be an effective verbal communicator, it is necessary to understand that the words you use convey meanings that you might intentionally or unintentionally communicate to others. However, the meaning of language can vary from person to person.

This chapter also discusses the various rules of language. Verbal communication serves many purposes and works to clarify the meaning of nonverbal communication. The type of language that you use can impact how others will see you.

Finally, this chapter discusses the subcategories of verbal communication. The subcategories of verbal communication allow us to understand how misunderstandings might occur if language is not used effectively.

End of Chapter

KEY TERMS

- Abstract
- Abstraction Ladder
- Affiliation
- Ambiguous Language
- Bias
- Biased Language
- Buzz Word
- Cliché
- Colloquialism
- Connotation
- Converge
- Denotation
- Discourse
- Diverge
- Euphemism
- Formal Language
- Heuristic Function
- Idiom
- Imaginative Function
- Informal Language
- Instrumental Function
- Interactional Function
- Jargon
- Language
- Language Adaptation
- Language Awareness
- Linguistic Determinism
- Linguistic Relativity
- Metamessage
- Personal Function
- Racism
- Racist Language
- Racist Language
- Regulatory Function
- Relative Language
- Representational Function
- Sapir-Whorf Hypothesis
- Sexism
- Sexist Language
- Sexist Language
- Slang
- Spin
- Static Evaluation
- Vocabulary

REAL WORLD CASE STUDY

Kory was an introverted and timid sixth-grader who moved to a new school. One day, he was searching on the Internet and he came across a negative website about him posted by some of his classmates. On the webpage, many of the students called him horrible names and made some damaging and hurtful remarks about his looks and sexuality. Every day, the words would get worse. The language became unbearable, and he went through a lot of torment because all of the statements about him were untrue. Kory had endured cyberbullying. He had considered suicide.

Cyberbullying seems to be a growing problem these days. Think about the ways you

1. What are some ways to help Kory?
2. What should Kory do?
3. How should he respond?

END OF CHAPTER QUIZ

1. The fact that the words “Come Here!” can have different interpretations based on the source of the message is related to:
 - a. semantic
 - b. verbal
 - c. syntactic
 - d. pragmatic
 - e. discourse
2. According to the abstraction ladder, which of the following statements is the most abstract?
 - a. You are lazy!
 - b. You need to tell me what I need to do to lose five pounds this month.
 - c. You should workout.
 - d. You need to eat healthier.
 - e. That dress is too small on you and does not fit.
3. Larry is madly in love with Sarah. You can tell this when he tells he brings her flowers or writes new songs to sing to her. Larry is using _____ to convey his feelings.
 - a. abstraction
 - b. connotation
 - c. denotation
 - d. discourse
 - e. metamessages
4. Saying “I love you” every time you see your grandmother is a _____ function.
 - a. regulatory
 - b. imaginative
 - c. interactional
 - d. personal
 - e. ritual
5. In this chapter, you learned all of the following except:
 - a. how naming affects perceptions
 - b. language can impact affiliations
 - c. there are three different rules to understanding language
 - d. language can be sexist or racist
 - e. language can influence perceptions of credibility

References

- 1 Lakoff, R. T. (2001). *Language war*. Ewing, NJ: University of California Press; pg. 20.
- 2 Gamble, T. K., & Gamble, M. W. (2014). *Interpersonal Communication: Building Connections Together*. Thousand Oaks, CA: Sage.
- 3 Hayakawa, S. I. (1941). *Language in thought and action*. Harcourt, Brace, & Company.
- 4 Watzlawick, P., Beavin, J. H., & Jackson, D. D. (1967). *Pragmatics of human communication*. New York: W. W. Norton.
- 5 Ogden, C. K., & Richards, I. A. (1923). *The Meaning of Meaning: A Study of the Influence of Language upon Thought and of the Science of Symbolism* (Vol. 29). K. Paul, Trench, Trubner & Company, Limited.
- 6 Halliday, M. A. K., & Webster, J. J. (Ed.). (2004). *Language of early childhood*. Continuum International Publishing.
- 7 Deutscher, G. (2010). *Through the language glass: Why the world looks different in other languages*. Metropolitan Books.
- 8 Kelly, L. (2019, February 8). Do Inuits really have 50 words for snow? *Readable*. <https://readable.com/blog/do-inuits-really-have-50-words-for-snow/>
- 9 Tohidian, I. (2009). Examining linguistic relativity hypothesis as one of the main views on the relationship between language and thought. *Journal of Psycholinguistic Research*, 38(1), 65-74. <https://doi.org/10.1007/s10936-008-9083-1>
- 10 Whorf, B. L. (1956) An American Indian model of the universe. In J. B. Carroll (Ed.). *Language, thought, and reality: Selected writings of Benjamin Lee Whorf* (pp. 57-64). Technology Press of Massachusetts Institute of Technology. pp. 57-64; pg. 57.
- 11 Whorf, B. L. (1956). The relation of habitual thought and behavior to language. In J. B. Carroll (Ed.). *Language, thought, and reality: Selected writings of Benjamin Lee Whorf* (pp. 134-159). MIT Press.
- 12 Lieberman, S. (2000). *A matter of taste: How names, fashions, and culture change*. Yale University Press.
- 13 Christensend, N., & Larsen, B. (2008). The name game. *The Psychologist*, 21, 210-213. <https://the-psychologist.bps.org.uk/volume-21/edition-3/name-game>
- 14 Weingarten, G. (2003, September 21). Signs of a troubled society. *The Washington Post*. <https://tinyurl.com/v629xnn>
- 15 Levitt, S. D., & Dubner, S. J. (2005). *Freakonomics: A rogue economist explores the hidden side of everything*. William Morrow.
- 16 Ireland, M. E., Slatcher, R. B., Eastwick, P. W., Scissors, L. E., Finkel, E. J., & Pennebaker, J. W. (2011). Language style matching predicts relationship initiation and stability. *Psychological Science*, 22 (1), 39 - 44. <https://doi.org/10.1177/0956797610392928>
- 17 Dunleavy, K. N., & Booth-Butterfield, M. (2009). Idiomatic communication in the stages of coming together and falling apart. *Communication Quarterly*, 57(4), 416-432. <https://doi.org/10.1080/01463370903320906>
- 18 Parks, J. B., & Robertson, M. A. (2008). Generation gaps in attitudes toward sexist/nonsexist language. *Journal of Language & Social Psychology*, 27(3), 276-283. <https://doi.org/10.1177/0261927X08317956>
- 19 Smith- McLallen, A, Johnson, B. T., Dovidio, J. F., & Pearson, A. R. (2006). Black and white: The role of color bias and implicit race bias. *Social Cognition*, 24(1), 46-73. <https://doi.org/10.1521/soco.2006.24.1.46>
- 20 Harris, A. K. (1999). A revolutionary view of communication: Cheris Kramarae's theory of muted groups. *Women & Language*, 22(2), 54-54.
- 21 Kramarae, C. (2005). Muted group theory and communication: Asking dangerous questions. *Women and language*, 28(2), 55.
- 22 Kofoed, J. (2008). Muted transitions. *European Journal of Psychology of Education*, 23(2), 199-212. <https://doi.org/10.1007/BF03172745>
- 23 Murray, N. (2012). *Writing essays in English language and linguistics: Principles, tips and strategies for undergraduates*. Cambridge University Press; p. 147

- 24 Cutrara, J. (2017, September 11). 14 business jargon phrases people love to hate. *Grammarly Blog*. <https://www.grammarly.com/blog/business-jargon-phrases/>
- 25 Trudgill, P. (2000). *Sociolinguistics: An introduction to language and society*. Penguin, pg. 17.
- 26 Mattiello, E. (2008). *An introduction to English slang: a description of its morphology, semantics and sociology*. Polimetrica.
- 27 Nunberg, G., Sag, I. A., & Wasow, T. (1994). Idioms. *Language*, 70(3), 491-538.
- 28 Blake, G., & Bly, R. W. (1993). *The elements of technical writing*. Macmillan, pg. 85.
- 29 Ioannidou, E. (2009). Using the 'improper' language in the classroom: The conflict between language use and legitimate varieties in education. Evidence from a Greek Cypriot classroom. *Language and Education*, 23(3), 263-278. <https://doi.org/10.1080/09500780802691744>
- 30 Poteat, V. P., & DiGiovanni, C. D. (2010). When biased language use is associated with bullying and dominance behavior: The moderating effect of prejudice. *Journal of Youth and Adolescence*, 39(10), 1123-1133. <https://doi.org/10.1007/s10964-010-9565-y>
- 31 Westlund Stewart, N., Wilson, A. W., & Drewery, D. W. (2020). Mindfulness exercises for written communication: Key issues in large classrooms. *Innovations in Education and Teaching International*, 57(1), 109-118. <https://doi.org/10.1080/14703297.2019.1567369>
- 32 Khan, T. (2015). *Improve your vocabulary: Enriching word power the fun way*. V&S Publishers.
- 33 Crystal, D. (2006). *How language works: How babies babble, words change meaning, and languages live or die*. Harry N. Abrams.
- 34 G., R. L. (2013, May 29). Vocabulary size: Lexical facts. *The Economist*. <https://www.economist.com/johnson/2013/05/29/lexical-facts>
- 35 Svalberg, A. M. (2007). Language awareness and language learning. *Language Teaching*, 40(4), 287-308. <https://doi.org/10.1017/S0261444807004491>
- 36 Rauschenbach, J. (1994). Checking for student understanding: Four techniques. *Journal of Physical Education, Recreation & Dance*, 65(4), 60-63. <https://doi.org/10.1080/07303084.1994.10606900>

END OF CHAPTER QUIZ

ANSWER KEY

1) D 2) A 3) E 4) E 5) E





Chapter 5

Nonverbal

Communication

Nonverbal communication is defined as communication that is produced by some means other than words (eye contact, body language, or vocal cues, for example).¹ Over the past decade, Botox has been used to paralyze facial muscles for the purpose of reducing the appearance of wrinkles. However, the unintended consequence of this practice is reduced facial expression! The frozen facial expression was recently celebrated by Shape.com, who interviewed

a noted plastic surgeon about Hollywood’s most notable “frozen faces” (See Figure 5.1). The reality starlet pictured is only 40, but she is already a fan of Botox, “as you can tell by her taught forehead,” Dr. Youn says. “Some stars start treatment early, hoping to prevent wrinkles, but risk robbing their face of natural emotions in the process!”

Imagine the lack of a variety of emotional facial

Figure 5.1 Celebrity Frozen Face “Kim Kardashian at the 2009 Tribeca Film Festival for the premiere of ‘Wonderful World’.” by David Shankbone. This file is licensed under the Creative Commons Attribution 3.0 Unported license.

expressions if everyone's face was frozen. The world would be a much less interesting place, and it would be more challenging to stimulate accurate meaning in the minds of others; thus, we will begin this chapter by discussing the importance of nonverbal communication.

5.1 Importance of Nonverbal Communication in Interaction

LEARNING OUTCOMES

1. Understand the importance of nonverbal communication.
2. Differentiate between the functions of nonverbal communication.
3. Understand the functions of nonverbal communication in day-to-day interactions.
4. Understand and provide examples of the subcategories of nonverbal communication.

Earlier in this book, we introduced the concept of “you cannot, not communicate.” The foundation for this idea is that even though we may not be sending verbal messages, we are continually sending nonverbal messages. As such, it's very important to understand how nonverbal messages impact our daily interpersonal interactions. In this section, we're going to discuss the role that nonverbal communication plays in our daily lives and the six functions of nonverbal communication.

The Role of Nonverbal in Everyday Life

We communicate nonverbally constantly. It's the primary way that we communicate with other people. In this section, we're going to explore the role that nonverbal communication plays in our day-to-day lives.

Nonverbal has Communicative Value

The meaning associated with nonverbal communication in any given interaction cannot be underestimated. In this chapter, you will learn about the many types of nonverbal communication present in the interaction. For example, if you are having a conversation with your friend who just broke up with her girlfriend, you will use more than the words, “I just broke up with my girlfriend” to understand how to communicate with your friend. Your friend's facial expression, way of standing, rate of speech, tone of voice, and general appearance, just to name a few, will indicate to you how you should respond. If she is sobbing, gasping for air, hunched over, and appears emotionally pained, you might attempt to comfort her. If she says, “I just broke up with my girlfriend” and sighs while placing her hand over her heart, she might appear relieved. Your response might be, “it seems like you may be a little relieved. Were things not going well?”

Thus, nonverbal communication plays a tremendous role in successfully engaging in interactions. The successful use of nonverbal communication requires an awareness of the value of nonverbal communication and the belief that it is valuable. When individuals are unaware of the importance of nonverbal communication, they may be overlooking crucial interactional information. For example, one

of the authors of this textbook was once meeting with a colleague who was repeatedly sighing during a meeting. Later, when she and her colleague were discussing the meeting, he said, “Didn’t you notice that I was sighing?” She told him she did notice that he was sighing, but she was unsure why. We will discuss this further in the ambiguity of nonverbal communication. In this example, the author’s colleague was aware of the importance of nonverbal communication and attempted to use it deliberately.

In addition to awareness, individuals must believe that nonverbal communication is valuable. If your parent/guardian ever said to you, “it wasn’t what you said, it was how you said it,” then your parent/guardian was demonstrating a belief that nonverbal communication is essential. An individual may acknowledge that nonverbal communication exists but may discount its value. For example, one of the authors had a recurring argument with the author’s spouse, who would sigh or roll her eyes as a response in interaction. The author would ask the spouse what it meant, and the spouse would inevitably say, “I can sigh or roll my eyes without it meaning anything.” This is not an uncommon response, but the authors of this text hope to dispel this perception.

For a better understanding of the value of communication, Google “value of communication.” Your search will return over a billion links. While it is not possible to review all of the search results, read through a few of the articles. For this exercise we found titles like “The Value of Effective Communication in the Workplace”^a and “Why Communication Is Today’s Most Important Skill.”² In fact, we found almost 300,000 articles with the phrase “value of communication.” These news articles tell readers that effective communication secures customer, creates bonds between employees, and increases revenues.

Nonverbal Used for Relational Purposes

Nonverbal communication is an essential element in relating to others. Nonverbal communication is often the very first way in which we invite a relationship with another, or, at the very least, invite communication. To communicate with another, we must make eye contact with a few exceptions. Thus, relationships begin with nonverbal communication. Also, consider how humans relate to others through touch, scent, hand gestures, physical appearance, and more.

Humans often use nonverbal communication to relay to others an interest in continuing a conversation or leaving a conversation. For example, you may run into a colleague and strike up a spontaneous conversation in the hall. The conversation is enjoyable, and you each relate to the other that you are enjoying conversing about work. Your colleague may recognize that he needs to get to a meeting and relates this information to you by looking at his watch, beginning to back away, or looking at the door he needs to enter.

Another way in which we relate to others via nonverbal communication is through the communication of emotion. Through a myriad of nonverbal behaviors, we can communicate emotions such as joy, happiness, and sadness. The nonverbal expression of emotion allows others to know how to communicate with us.

Nonverbal is Ambiguous

A particularly challenging aspect of nonverbal communication is the fact that it is ambiguous. In the seventies, nonverbal communication as a topic was trendy. Some were under the impression that we could use nonverbal communication to “read others like a book.” One of the authors remembers her cousin’s wife telling her that she shouldn’t cross her arms because it signaled to others that she was closed off. It would be wonderful if crossing one’s arms signaled one meaning, but think about the many

meanings of crossing one's arms. An individual may have crossed arms because the individual is cold, upset, sad, or angry. It is impossible to know unless a conversation is paired with nonverbal behavior.

Another great example of ambiguous nonverbal behavior is flirting! Consider some very stereotypical behavior of flirting (e.g., smiling, laughing, a light touch on the arm, or prolonged eye contact). Each of these behaviors signals interest to others. The question is whether an individual engaging in these behaviors is indicating romantic interest or a desire for platonic friendship...have you ever walked away from a situation and explained a person's behavior to another friend to determine whether you were being flirted with? If so, you have undoubtedly experienced the ambiguity of nonverbal communication.

Nonverbal is Culturally Based

Just as we have discussed that it is beneficial to recognize the value of nonverbal communication, we must also acknowledge that nonverbal communication is culturally based. Successful interactions with individuals from other cultures are partially based on the ability to adapt to or understand the nonverbal behaviors associated with different cultures. There are two aspects to understanding that nonverbal communication is culturally based. The first aspect is recognizing that even if we do not know the appropriate nonverbal communication with someone from another culture, then we must at least acknowledge that there is a need to be flexible, not react, and ask questions. The second aspect is recognizing that there are specific aspects of nonverbal communication that differ depending on the culture. When entering a new culture, we must learn the rules of the culture.

Regarding recognizing differences, you may encounter someone from a culture that communicates very differently from you and perhaps in an unexpected way. For example, one of the author's brothers, Patrick, was working in Afghanistan as a contractor on a military base. He was working with a man from Africa. During their first conversation, he held Patrick's hand. Patrick later told his sister, the author, this story and said he wasn't sure how to respond, so he "just rolled with it." Patrick's response allowed for the most flexibility in the situation and the best chance of moving forward productively. Imagine if he had withdrawn his hand quickly with a surprised look on his face. The outcome of the interaction would have been very different.

Patrick's response also exemplifies the second aspect of understanding that nonverbal communication is culturally based. Patrick was hired by a contractor to work on the military base in Afghanistan. The contracting firm could have trained Patrick and his coworkers about communicating with the various cultures they would encounter on the base. For example, many people from the Philippines were working on the base. It would have been helpful for the contractors to explain that there may be differences in spatial distance and touch when communicating with other males from the Philippines. Researching and understanding the nonverbal communication of different countries before entering the country can often mean a smoother entry phase, whether conducting business or simply visiting.

Attribution Error

A final area to address before examining specific aspects of nonverbal communication is "attribution error." **Attribution error** is defined as the tendency to explain another individual's behavior in relation to the individual's internal tendencies rather than an external factor.³ For example, if a friend is late, we might attribute this failure to be on time as the friend being irresponsible rather than running through a list of external factors that may have influenced the friend's ability to be on time such as an emergency, traffic, read the time wrong, etc. It is easy to make an error when trying to attribute meaning to the behaviors of others, and nonverbal communication is particularly vulnerable to attribution error.

On Saturday, September 8, 2018, Serena Williams may have been a victim of an umpire's attribution error on the part of the judge. Let's just say Serena did suffer as a result of attribution error. The judge spotted Serena Williams' coach gesturing in the audience and assumed that the gesture was explicitly directed toward Serena as a means to coach her. Her coach later acknowledged that he was "coaching" via nonverbal signals, but Serena was not looking at him, nor was she intended to be a recipient. Her coach indicated that all coaches gesture while sitting in the stands as though they are coaching a practice and that it's a habit and not an other-oriented communication behavior. This is a perfect example of attribution error. The judge attributed the coaches' gesture to the coach intending to communicate rather than the gesture merely being due to habit. The judge's attribution error may have cost Serena Williams' comeback match. While the stakes may not be so high in day-to-day interaction, attribution error can create relational strife and general misunderstandings that can be avoided if we recognize that it is necessary to understand the intention behind a specific nonverbal behavior.

Omnipresent

According to Dictionary.com, omnipresent is indicative of being everywhere at the same time. Nonverbal communication is always present. Silence is an excellent example of nonverbal communication being omnipresent. Have you ever given someone the "silent treatment?" If so, you understand that by remaining silent, you are trying to convey some meaning, such as "You hurt me" or "I'm really upset with you." Thus, silence makes nonverbal communication omnipresent.

Another way of considering the omnipresence of nonverbal communication is to consider the way we walk, posture, engage in facial expression, eye contact, lack of eye contact, gestures, etc. When sitting alone in the library working, your posture may be communicating something to others. If you need to focus and don't want to invite communication, you may keep your head down and avoid eye contact. Suppose you are walking across campus at a brisk pace. What might your pace be communicating?

When discussing the omnipresence of nonverbal communication, it is necessary to discuss Paul Watzlawick's assertion that humans cannot, not communicate. This assertion is the first axiom of his interactional view of communication. According to Watzlawick, humans are always communicating. As discussed in the "silent treatment" example and the posture and walking example, communication is found in everyday behaviors that are common to all humans. We might conclude that humans cannot escape communicating meaning.

Can Form Universal Language

When discussing whether nonverbal communication is a universal language, caution must be used. We must remember that understanding the context in which nonverbal communication is used is almost always necessary to understand the meaning of nonverbal communication. However, there are exceptions concerning what Paul Ekman calls "basic emotions." These will be discussed a bit later in the chapter.

Can Lead to Misunderstandings

Comedian Samuel J. Comroe has tremendous expertise in explaining how nonverbal communication can be misunderstood. Comroe's comedic routines focus on how Tourette's syndrome affects his daily living. Tourette's syndrome can change individual behavior, from uncontrolled body movements to uncontrolled vocalizations. Comroe often appears to be winking when he is not. He explains how his "wink" can cause others to believe he is joking when he isn't. He also tells the story of how he met his

wife in high school. During a skit, he played a criminal and she played a police officer. She told him to “freeze,” and he continued to move (due to Tourette’s). She misunderstood his movement to mean he was being defiant and thus “took him down.” [You can watch Comroe’s routine here.](#)

Although nonverbal misunderstandings can be humorous, these misunderstandings can affect interpersonal as well as professional relationships. One of the authors once went on an important job interview for a job she was not offered. She asked the interviewer for feedback, and he said, “your answers sounded canned.” The author did not think to do so in the moment, but what she should have said is that she may have sounded canned because she frequently thinks about work, her work philosophy, and how she approaches work. Thus, her tone may have been more indicative of simply knowing how she feels rather than “canned.”

As you continue to learn about nonverbal communication, consider how you come to understand nonverbal communication in interactions. Sometimes, the meaning of nonverbal communication can be fairly obvious. Most of the time a head nod in conversation means something positive such as agreement, “yes,” keep talking, etc. At other times, the meaning of nonverbal communication isn’t clear. Have you ever asked a friend, “did she sound rude to you” about a customer service representative? If so, you are familiar with the ambiguity of nonverbal communication.

Usually Trusted

Despite the pitfalls of nonverbal communication, individuals typically rely on nonverbal communication to understand the meaning in interactions. Communication scholars agree that the majority of meaning in any interaction is attributable to nonverbal communication. It isn’t necessarily true, but we are taught from a very early age that lack of eye contact is indicative of lying. We have learned through research that this “myth” is not necessarily true; this myth does tell a story about how our culture views nonverbal communication. That view is simply that nonverbal communication is important and that it has meaning.

Another excellent example of nonverbal communication being trusted may be related to a scenario many have experienced. At times, children, adolescents, and teenagers will be required by their parents/guardians to say, “I’m sorry” to a sibling or the parent/guardian. Alternatively, you may have said “yes” to your parents/guardians, but your parent/guardian doesn’t believe you. A parent/guardian might say in either of these scenarios, “it wasn’t what you said, it was how you said it.” Thus, we find yet another example of nonverbal communication being the “go-to” for meaning in an interaction.

According to research, as much as 93% of meaning in any interaction is attributable to nonverbal

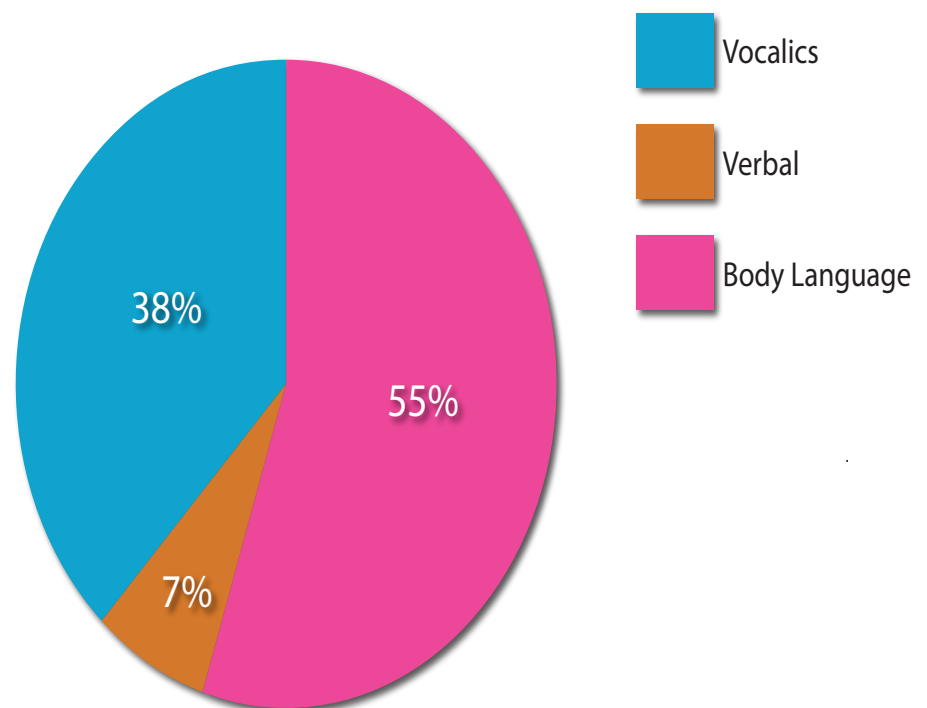

Figure 5.2 Mehrabian’s Explanation of Message Meaning

communication. Albert Mehrabian asserts that this 93% of meaning can be broken into three parts (Figure 5.2)⁴

Mehrabian's work is widely reported and accepted. Other researchers Birdwhistell and Philpott say that meaning attributed to nonverbal communication in interactions ranges from 60 to 70%.^{5,6} Regardless of the actual percentage, it is worth noting that the majority of meaning in interaction is deduced from nonverbal communication.

The Six Functions of Nonverbal Communication

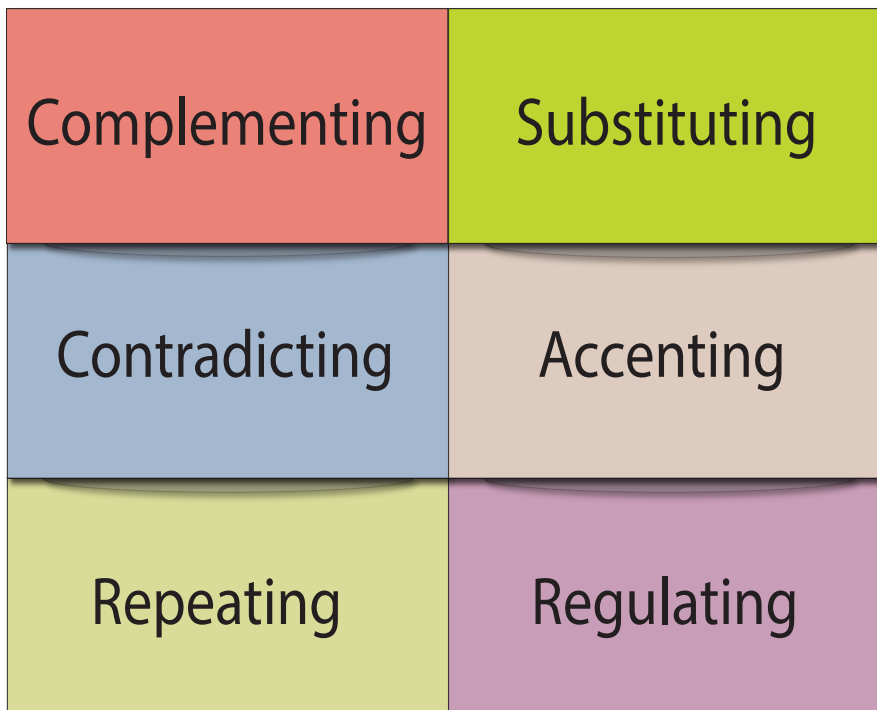

Figure 5.3 Six Functions of Nonverbal Communication

As we have established, nonverbal communication plays an important role in communicating successfully and effectively. Because nonverbal communication plays a significant role in interactions, nonverbal communication was studied heavily in the early days of studying communication. These studies resulted in the discovery of multiple utilitarian functions of nonverbal communication (Figure 5.3)

Complementing

Complementing is defined as nonverbal behavior that is used in combination with the verbal portion of the message to emphasize the meaning of the entire message.

An excellent example of

complementing behavior is when a child is exclaiming, "I'm so excited" while jumping up and down. The child's body is further emphasizing the meaning of "I'm so excited."

Contradicting

At times, an individual's nonverbal communication contradicts verbal communication. Recently, when visiting an aunt's house, one of the author's folded her arms. She asked the author if she was cold and if she needed to turn up the air conditioning. The author said no because she was trying to be polite, but her aunt did not believe her. The author's nonverbal communication gave away her actual discomfort! In this case, the nonverbal communication was truly more meaningful than verbal communication.

Consider a situation where a friend says, "The concert was amazing," but the friend's voice is monotone. A response might be, "oh, you sound real enthused." Communication scholars refer to this as "contradicting" verbal and nonverbal behavior. When contradicting occurs, the verbal and nonverbal messages are incongruent. This incongruence heightens our awareness, and we tend to believe the nonverbal communication over verbal communication.

Accenting

Accenting is a form of nonverbal communication that emphasizes a word or a part of a message. The word or part of the message accented might change the meaning of the message. Accenting can be accomplished through multiple types of nonverbal behaviors. Gestures paired with a word can provide emphasis, such as when an individual says, “no (slams hand on table), you don’t understand me.” By slamming the hand on a table while saying “no,” the source draws attention to the word. Words or phrases can also be emphasized via pauses. Speakers will often pause before saying something important. Your professors likely pause just before relaying information that is important to the course content.

Repeating

Nonverbal communication that repeats the meaning of verbal communication assists the receiver by reinforcing the words of the sender. Nonverbal communication that repeats verbal communication may stand alone, but when paired with verbal communication, it serves to repeat the message. For example, nodding one’s head while saying “yes” serves to reinforce the meaning of the word “yes,” and the word “yes” reinforces the head nod.

Regulating

Regulating the flow of communication is often accomplished through nonverbal behavior communication. Paul Ekman and Wallace Friesen state that regulators are “acts which maintain and regulate the back-and-forth nature of speaking and listening between two or more interactions” (1969, p. 82). You may notice your friends nodding their heads when you are speaking. Nodding one’s head is a primary means of regulating communication. Other behaviors that regulate conversational flow are eye contact, moving or leaning forward, changing posture, and eyebrow raises, to name a few. You may also have noticed several nonverbal behaviors people engage in when trying to exit a conversation. These behaviors include stepping away from the speaker, checking one’s watch/phone for the time, or packing up belongings. These are referred to as leave-taking behaviors. Without the regulating function of nonverbal behaviors, it would be necessary to interrupt conversational content to insert phrases such as “I have to leave.” However, when interactants fail to recognize regulating behavior, verbal communication will be used instead.

Substituting

At times, nonverbal behavior serves to replace verbal communication altogether. Substituting nonverbal behaviors must be understood within a context more often than not. For example, a friend may ask you what time it is, and you may shrug your shoulders to indicate you don’t know. At other times, your friend may ask whether you want pizza or sushi for dinner, and you may shrug your shoulders to indicate you don’t care or have no preference.

Emblems are a specific type of substituting nonverbal behavior that have direct verbal translation. Emblems may generally be understood outside of the context in which they are used. Some highly recognizable emblems in the U.S. culture are the peace sign and the okay sign. Emblems are a generally understood concept and have made their way into popular culture. The term “emblem” may not be applied within popular culture. In the popular television show, *Friends*, the main characters Ross and Monica are siblings. Ross and Monica are forbidden to “flip the bird” to each other, so they make up their own “emblem,” which involves holding one’s palms upward in a fist and bumping the outside of the

palm's together. Whether flipping the bird in the traditional manner or doing so Ross and Monica style, each of these represents an emblem that does not require context for accurate interpretation. Emblems will be discussed in greater depth later in the chapter.

Key Takeaways

- Nonverbal cues help the receiver decode verbal messages.
- Each function of nonverbal communication is distinct.
- The functions of nonverbal communication are evident in everyday interactions.

Exercises

- Create a list of five situations in which nonverbal communication helped you to accurately interpret verbal communication. Use the functions of nonverbal communication in your description.
- Reflect upon the functions of nonverbal communication and provide an example from your own life for each function.
- Experiment with nonverbal communication. Use an unexpected nonverbal cue when having conversations with friends throughout the day. For example, use a contradictory nonverbal cue such as shaking your head while saying yes. Note your friend's reaction and be ready to provide an explanation to your friend.

5.2 Categories of Nonverbal Communication

LEARNING OUTCOMES

1. Know the subcategories of nonverbal communication influencing interpersonal communication.
2. Understand how the categories of nonverbal communication influence perception.
3. Understand research findings associated with the categories of nonverbal communication.

In addition to the functions of nonverbal communication, there are categories of nonverbal communication. This chapter will address several categories of nonverbal communication that are of particular importance in interpersonal relationships. These categories include haptics (touch), vocalics (voice), kinesics (body movement and gestures), oculusics/facial expressions (eye and face behavior), and physical appearance. Each of these categories influences interpersonal communication and may have an impact on the success of interpersonal interactions.

Haptics

Haptics is the study of touch as a form of nonverbal communication. Touch is used in many ways in our

daily lives, such as greeting, comfort, affection, task accomplishment, and control. You may have engaged in a few or all of these behaviors today. If you shook hands with someone, hugged a friend, kissed your romantic partner, then you used touch to greet and give affection. If you visited a salon to have your hair cut, then you were touched with the purpose of task accomplishment. You may have encountered a friend who was upset and patted the friend to ease the pain and provide comfort. Finally, you may recall your parents or guardians putting an arm around your shoulder to help you walk faster if there was a need to hurry you along. In this case, your parent/guardian was using touch for control.

Several factors impact how touch is perceived. These factors are duration, frequency, and intensity. Duration is how long touch endures. Frequency is how often touch is used, and intensity is the amount of pressure applied. These factors influence how individuals are evaluated in social interactions. For example, researchers state, “a handshake preceding social interactions positively influenced the way individuals evaluated the social interaction partners and their interest in further interactions while reversing the impact of negative impressions.”⁷ This research demonstrates that individuals must understand when it is appropriate to shake hands and that there are negative consequences for failing to do so. Importantly, an appropriately timed handshake can erase the negative effects of any mistakes one might make in an initial interaction!

Touch is a form of communication that can be used to initiate, regulate, and maintain relationships. It is a very powerful form of communication that can be used to communicate messages ranging from comfort to power. Duration, frequency, and intensity of touch can be used to convey liking, attraction, or dominance. Touch can be helpful or harmful and must be used appropriately to have effective relationships with family, friends, and romantic partners. Consider that inappropriate touch can convey romantic intentions where no romance exists. Conversely, fear can be instilled through touch. Touch is a powerful interpersonal tool along with voice and body movement.

It’s also essential to understand the importance of touch on someone’s psychological wellbeing. Narissra Punyanunt-Carter and Jason Wrench created the touch deprivation scale to examine the lack of haptic communication in an individual’s life (Table 5.1).⁸

As you can see, Punyanunt-Carter and Wrench found that there are three different factors related to touch deprivation: the absence of touch, longing for touch, and sexual intimacy for touch. First, the absence of touch is the degree to which an individual perceives that touch is not a normal part of their day-to-day interactions. Many people can go days or even weeks without physically having contact with another person. People may surround them on a day-to-day basis at work, but this doesn’t mean that they can engage in physical contact with other people.

Second, there is the longing for touch. It’s one thing to realize that touch is not a normal part of your day-to-day interactions, but it’s something completely different not to have that touch and desire that touch. For some people, the lack of touch can be psychologically straining because humans inherently have a desire for physical contact. For some people, this lack of physical contact with other humans can be satisfied by having a pet.

Lastly, some people desire touch so much that they’ll engage in sexual activity just as a way to get touched by another human being. Obviously, these types of situations can be risky because they involve sexual contact outside of an intimate relationship. In fact, “hooking up” can be detrimental to someone’s psychological wellbeing.⁹

In the Punyanunt-Carter and Wrench study, the researchers found that there was a positive relationship between touch deprivation and depression and a negative relationship between touch deprivation and self-esteem. The study also found that those individuals who felt that they did not receive enough touch growing up (tactile nurturance) also reported higher levels of touch deprivation as adults.

This is just a further indication of how important touch is for children and adolescents.

Vocalics

In this section, we are going to discuss vocalics, that is, vocal utterances, other than words, that serve as a form of communication. Our discussion will begin with vocal characteristics, including timbre, pitch, tempo, rhythm, and intensity.

Timbre

According to Merriam-Webster online dictionary, timbre refers to the “quality given to a sound by its overtones: such as the resonance by which the ear recognizes and identifies a voiced speech sound.” (<https://www.merriam-webster.com/dictionary/timbre> accessed on November 25, 2018.) Pitch refers to the frequency range between high and low. Pitch is not generally thought of much unless an individual’s pitch stands out. For example, if a female’s vocal pitch is low, meaning might be assigned to the low pitch, just as meaning might be attached to a male voice with a high pitch. Also, pitch that is at a higher or lower end of a range will be noticed if there is a momentary or situational change to an individual’s pitch that will trigger an assignment of meaning. For example, when children become excited or scared, they may be described as “squealing.” The situation will determine whether squealing children are thought to be excited or scared.

Tempo

Tempo refers to the rate at which one speaks. Changes in tempo can reflect emotions such as excitement or anger, physical wellbeing, or energy level. One of the author’s aunts is a brittle diabetic. When talking to her aunt, the author can detect whether the aunt’s blood sugar is too low if her aunt is speaking extremely slow. Rhythm refers to the pattern used when speaking. Unusual speaking rhythms are often imitated. Consider the speaking rhythm of a “surfer dude” or a “valley girl.” One of the most well-known forms of rhythm used in a speech was Martin Luther King, Jr.’s “I have a Dream” speech. More recently, the speaking rhythm of President’s Obama and Trump are easily identifiable and often imitated by comedians.

Intensity

Finally, intensity refers to how loudly or softly an individual speaks. Intensity can be tied to emotion. When individuals speak loudly, the increased volume may be used to convey anger, emotional distress, happiness, or heightened excitement. When individuals speak at a lower volume, the decreased volume may be an effort to diffuse an emotionally intense conversation. Lower volume could also be the result of sharing bad news, discussing taboo or sensitive topics (i.e., when people whisper “sex” or “she died”), or conveying private information.

Other Vocal Features

Paralanguage

Paralanguage is another term for vocalics and refers to “extra-linguistic” features involved in speaking,

Instructions: Read the following questions and select the answer that corresponds with how you perceive physical contact with other people. Do not be concerned if some of the items appear similar. Please use the scale below to rate the degree to which each statement applies to you:

Strongly Disagree 1	Disagree 2	Neutral 3	Agree 4	Strongly Agree 5
---------------------------	---------------	--------------	------------	---------------------

1. I do not receive as much touch in my life as normal people. _____
2. I receive a normal, healthy amount of touch from people. _____
3. Human touch is not a daily occurrence in my life. _____
4. Touch from other people is a very common and natural part of my daily life. _____
5. I often go for days without being touched by someone. _____
6. I often feel like I'm untouchable because of the lack of touch from others in my life. _____
7. I receive a variety of forms of touch from a variety of different people. _____
8. I can go long periods of time without being touched by another person. _____
9. There are days when I would do anything just to be touched by someone. _____
10. I have longed for the touch of another person, any person. _____
11. Some days I long to be held, but have no one to hold me. _____
12. I often wish I could get more hugs from others. _____
13. I've engaged in sexual behaviors for the pure purpose of being touched by someone. _____
14. I would never engage in sex with someone, just to be touched. _____

Scoring

To compute your scores follow the instructions below:

Absence of Touch

Step One: Add scores for items 1, 3, 5, 6, & 8 _____

Step Two: Add scores for items 2, 4, & 7 _____

Step Three: Add 18 to Step One. _____

Step Four: Subtract the score for Step two from the score for Step Three. _____

Longing for Touch

Step One: Add scores for items 9, 10, 11, & 12 _____

Sex for Touch

Step One: Add scores for item 13 _____

Step Two: Add scores for item 14 _____

Step Three: Add 6 to Step One. _____

Step Four: Subtract the score for Step Two from the score for Step Three. _____

Interpreting Your Score

For absence of touch, scores should be between 7 and 35. If your score is above 17, you are considered to have an absence of touch. If your score is below 16, then touch is a normal part of your daily life.

For longing for touch, scores should be between 4 and 20. If your score is above 10, you are considered to have a longing for touch in your life. If your score is below 9, then touch is a normal part of your daily life.

For sex for touch, scores should be between 2 and 10. If your score is above 5, you have probably engaged in sexual intimacy as a way of receiving touch in your life. If your score is below 5, then you probably have not in sexual intimacy as a way of receiving touch in your life.

Reference

Punyanunt-Carter, N. M., & Wrench, J. S. (2009). Development and validity testing of a measure of touch deprivation. *Human Communication, 12*, 67-76.

Table 5.1 Touch Deprivation Scale

such as the characteristics of speech just discussed, pauses and silences, and nonverbal vocalizations.

Pauses and Silences

Pauses and silences are an important part of creating meaning during an interaction. Pauses draw attention to important parts of messages. The “pregnant pause” is an extra-long pause that precedes particularly weighty information. Pauses are a type of silence that are brief in nature, but prolonged silence such as minutes, hours, or even days can be used to convey meaning as well. Consider a conversation in which the other person does not respond to you. What meaning is conveyed? Is the individual thinking? Is the individual hurt, angry, or too shocked to speak? Myriad meanings of silence help emphasize the significance of silence and that it is as impactful as verbal communication, if not more so.

Dysfluencies, Vocal Fillers, or Verbal Surrogates

Dysfluencies, vocal fillers, or verbal surrogates are sounds that we make as we attempt to fill dead air while we are thinking of what to say next. In the United States, “um” or “uh” are the most commonly used dysfluencies. In conversation, these dysfluencies may pass unnoticed by both the sender or receiver, but consider how the recognition of dysfluencies increases when listening to a speaker who says “uh” or “um” during a speech. When giving a presentation, the speaker may even call attention to dysfluencies by speaking of them directly, and audience members may become distracted by dysfluencies. One of the author’s classmates used to count the number of “ums” used by a particular professor who was known to frequently use “um” when teaching. Though focusing on dysfluencies may be common, it is best for the speaker to attempt to reduce an excessive amount of dysfluencies and for listeners to focus on the meaning rather than the “ums” and “uhs.”

Kinesics

Kinesics, first coined by Ray Birdwhistell, is the study of how gestures, facial expression, and eye behavior communicate. Gestures can generally be considered any visible movement of the body. These movements “stimulate meaning” in the minds of others.

Facial Expressions

Facial expressions are another form of kinesics. Paul Eckman and Wallace V. Friesen asserted that facial expressions are likely to communicate “affect” or liking.¹⁰ Eckman and Friesen present seven emotions that are recognized throughout the world. These emotions are often referred to by the acronym S.A.D.F.I.S.H. and include surprise, anger, disgust, fear, interest, sadness, and happiness. Facial expressions are especially useful in communicating emotion. Although not all facial expression is “universally” recognized, people are generally able to interpret facial expressions within a context. We generally consider happiness is indicated by a smile. Smiling might, however, also communicate politeness, a desire to be pleasing, and even fear. If an individual attempts to use a smile to diffuse a volatile interaction where the individual fears being attacked verbally or physically, then the smile may be an indication of fear. In this case, the smile cannot be accurately interpreted outside of the context.

In a study investigating preferences for facial expressions in relation to the Big Five personality traits, it was found that most participants showed the strongest preferences for faces communicating high levels of agreeableness and extraversion. Individuals who are high in openness preferred a display of all facially-communicated Big Five personality traits. In relation to females who report being highly neurotic, they preferred male faces displaying agreeableness and female faces communicating disagreeableness. Male faces communicating openness were preferred by males who were higher in neuroticism. Interestingly, males reporting higher levels of neuroticism had a lower preference for female faces communicating openness.¹¹ This study underscores the importance of facial expressions in determining who we prefer.

Oculesics

Oculesics is the study of how individuals communicate through eye behavior. Eye contact is generally the first form of communication for interactants. Consider when a stranger speaks to you in a grocery store from behind you with a question such as, “Can you reach the Frosted Flakes for me?” When a general question such as this is asked with no eye contact, you may not be aware that the question was meant for

you.

Often when discussing eye behavior, researchers refer to “gaze.” Research consistently demonstrates that females gaze at interaction partners more frequently than males.^{12,13,14} Also, gaze has been studied concerning deception. Early research determined the significance of eye contact in the interpretation behavior. When people gaze too long or for too little, there is likely to be a negative interpretation of this behavior.¹⁵ However, later researchers acknowledge that there is a much greater range of acceptable “gazing” as influenced by verbal communication.

Gestures

Kinesics serve multiple functions when communicating—such as emblems, illustrators, affect displays, and regulators.

Emblems

Many gestures are emblems. You may recall from earlier in the chapter that gestures are clear and unambiguous and have a verbal equivalent in a given culture.¹⁶ Only a handful of emblematic gestures seem to be universal, for example, a shrug of the shoulders to indicate “I don’t know.” Most emblems are culturally determined, and they can get you into difficulty if you use them in other countries. In the United States, some emblematic gestures are the thumb-up-and-out hitchhiking sign, the circled thumb and index finger Ok sign, and the “V” for victory sign. However, be careful of using these gestures outside the United States. The thumb-up sign in Iran, for example, is an obscene gesture, and our Ok sign has sexual connotations in Ethiopia and Mexico.¹⁷

Illustrators

While emblems can be used as direct substitutions for words, illustrators help emphasize or explain a word. Recall the Smashmouth lyric in All Star: “She was looking kind of dumb with her finger and her thumb in the shape of an L on her forehead.” The “L” gesture is often used to illustrate “loser.”

Affect Displays

Affect displays show feelings and emotions. Consider how music and sports fans show enthusiasm. It is not uncommon to see grown men and women jumping up and down at sports events during a particularly exciting moment in a game. However, there are different norms depending on the sport. It would simply be inappropriate to demonstrate the same nonverbal gestures at a golf or tennis game as a football game.

Regulators

Regulators, as discussed earlier, are gestures that help coordinate the flow of conversation, such as when you shrug your shoulders or wink. Head nods, eye contact/aversion, hand movements, and changes in posture are considered to be turn-taking cues in conversation. Individuals may sit back when listening but shift forward to indicate a desire to speak. Eye contact shifts frequently during a conversation to indicate listening or a desire to speak. Head nods are used as a sign of listening and often indicate that the speaker should continue speaking.

Proxemics

Proxemics is the study of communication through space. Space as communication was heavily studied by Edward T. Hall,¹⁸ and he famously categorized space into four “distances. These distances represent how space is used and by whom (Figure 5.4).

Hall’s first distance is referred to as intimate space and is often referred to as our “personal bubble.” This bubble ranges from 0 to 18 inches from the body. This space is reserved for those with whom we have close personal relationships.

The next distance is referred to as personal space and ranges from 18 inches to 4 feet. You will notice that, as the distances move further away from the body, the intimacy of interactions decreases. Personal space is used for conversations with friends or family. If you meet a friend at the local coffee shop to catch up on life, it is likely that you will sit between 18 inches and four feet from your friend.

The next distance is “social” distance, ranging from 4 feet to 12 feet. This space is meant for acquaintances.

Finally, the greatest distance is referred to as “public” distance, ranging from 12 feet to 25 feet. In an uncrowded public space, we would not likely approach a stranger any closer than 12 feet. Consider an empty movie theatre. If you enter a theatre with only one other customer, you will not likely sit in the seat directly behind, beside, or in front of this individual. In all likelihood, you would sit further than 12 feet from this individual. However, as the theatre begins to fill, individuals will be forced to sit in Hall’s distances that represent more intimate relationships. How awkward do you feel if you have to sit directly next to a stranger in a theatre?

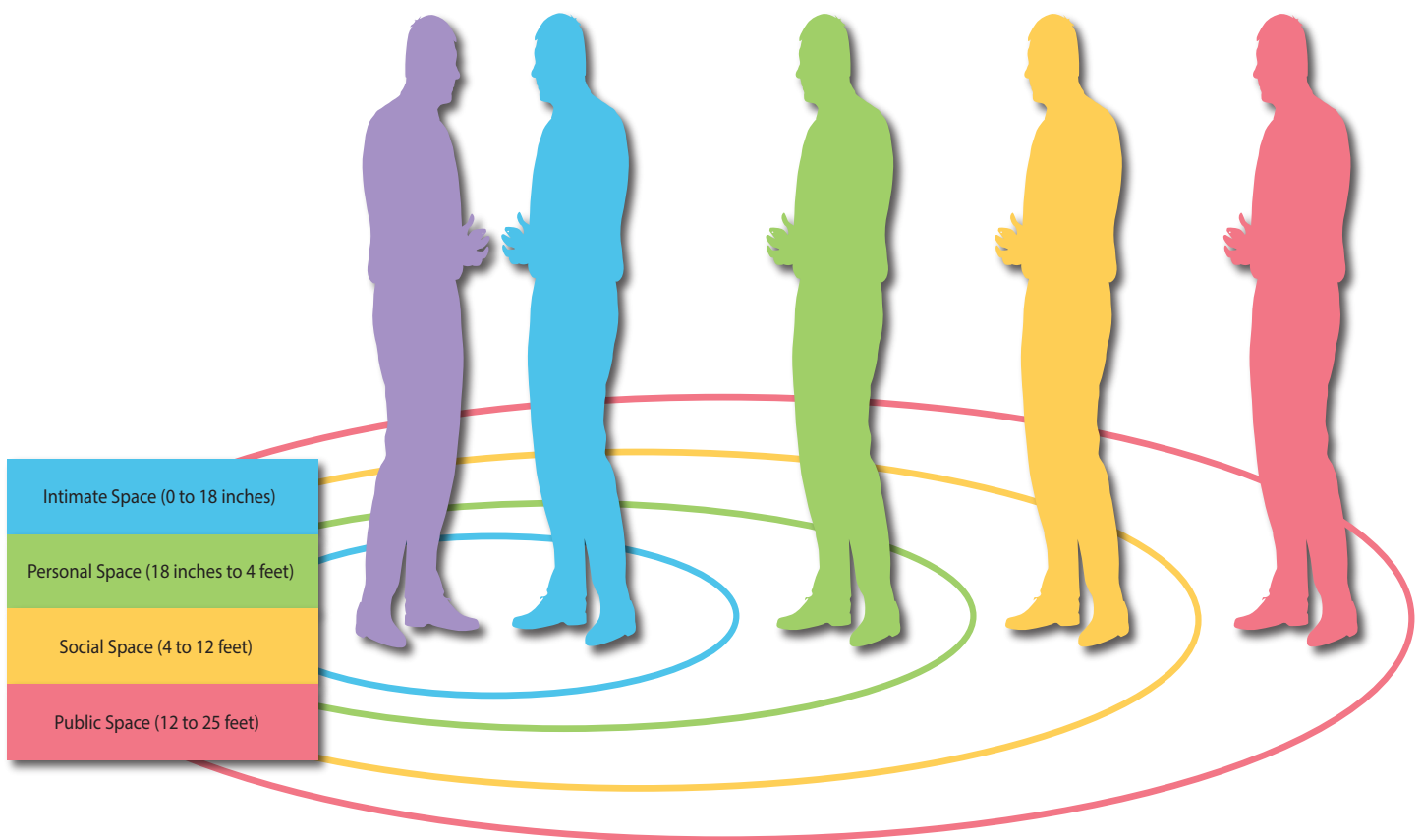

Figure 5.4 Edward T. Hall’s Four Spaces

Artifacts

Artifacts are items with which we adorn our bodies or which we carry with us. Artifacts include glasses, jewelry, canes, shoes, clothing, or any object associated with our body that communicates meaning. One very famous artifact that most everyone can recognize is the glasses of Harry Potter. Harry Potter's style of glasses has taken on their own meaning. What does his style of eyewear communicate when donned by others? Clothing also stimulates meaning. Do you recall Barney Stinson's famous line "suit up" in *How I Met Your Mother*? Why was it necessary to suit up? Recently, Snoop Dogg was given a star on the Hollywood Walk of Fame. Snoop Dogg was wearing a beautiful, classic camel hair overcoat. In contrast, he was wearing large bulky jewelry. What do these two types of artifacts communicate? One of the authors is a big fan. The author interpreted the classic overcoat as Snoop having excellent taste and the jewelry as strength and wealth. Together the artifacts were interpreted as power.

Chronemics

Chronemics, as explained by Thomas J. Bruneau,¹⁹ is the use of time to communicate. The use of time is considered to be culturally bound, with some cultures using monochronic time and others using polychronic time. Cultures using monochronic time engage in one task at a time. Cultures using polychronic time engage in multiple tasks at the same time. This use of time involves fluidity with individuals feeling free to work on multiple tasks simultaneously rather than completing a task before moving to the next task, as in the monochronic use of time. When considering how time is used, it is necessary to consider individual preferences as well as cultural preferences. Traditionally, the U.S. is a monochronic culture along with Canada or Northern Europe. Korea is an example of a polychronic culture along with Latin America, the Arab part of the Middle East, and Sub-Saharan Africa. However, one can live in each of these cultures and express the opposite orientation toward time. One of the authors is admittedly uptight when it comes to time. She is highly monochronic. This author went to a conference in Puerto Rico, which represents a polychronic orientation toward time. Buses usually run 30 minutes late, if not longer. Time is a bit more fluid rather than incremental in polychronic cultures. Unfortunately, the author failed to take this into account and nearly missed a presentation. This resulted in stress that could have been avoided had she remembered to pay more attention to the time orientation of those around her.

Olfactics

Finally, olfactics generally refers to the influence of scent on perceptions. Scent can draw others in or repel them, and the same scent can have different impacts on different people. According to statistica.com, the global estimated sales value of the fragrances worldwide in 2016 was \$47 billion U.S. dollars. This is in addition to \$39 billion U.S. dollars in shower and bath products and another \$20.5 billion in deodorants. The total spending in these categories was \$106.5 billion U.S. dollars. These figures underscore the importance of "smelling good" across the globe. Consider the impact of failing to manage one's natural scent in the workplace. Countless articles in the popular media address how to deal with a "smelly coworker." Thus, it is crucial to be aware of one's scent, including the ones we wear in an effort not to offend those around us. Although smelling "bad" may end a relationship or at least create distance, an attractive scent may help individuals begin a new relationship. Have you ever purchased a new scent before a first date? If so, you are aware of the power of scent to attract a mate. Although we regularly try to cover our scent, we also attempt to control the scent of our environments. The air freshener market in 2016 was valued at \$1.62 billion U.S. dollars. Go to your local grocery store and investigate the number

of products available to enhance environmental scents. Be prepared to spend a significant amount of time to take in the many products to keep our environments “fresh.”²⁰

The amount of money spent on fragrances for the body and home highlights the meaning of scent to humans. Ask yourself the following questions:

1. What meaning do you associate with a floral scent vs. a spicy scent?
2. When comparing men’s fragrances to women’s fragrances, what differences do you notice?
3. Are there scents that immediately transport you back in time, such as the smell of honeysuckle or freshly baked cookies?

Regardless of the scent you prefer, when using scent to communicate positively with others, do not make the mistake of believing the scent you like is loved by those around you!

Physical Appearance

Although not one of the traditional categories of nonverbal communication, we really should discuss physical appearance as a nonverbal message. Whether we like it or not, our physical appearance has an impact on how people relate to us and view us. Someone’s physical appearance is often one of the first reasons people decide to interact with each other in the first place.

Dany Ivy and Sean Wahl argue that physical appearance is a very important factor in nonverbal communication:

The connection between physical appearance and nonverbal communication needs to be made for two important reasons: (1) The decisions we make to maintain or alter our physical appearance reveal a great deal about who we are, and (2) the physical appearance of other people impacts our perception of them, how we communicate with them, how approachable they are, how attractive or unattractive they are, and so on.²¹

In fact, people ascribe all kinds of meanings based on their perceptions of how we physically appear to them. Everything from your height, skin tone, smile, weight, and hair (color, style, lack of, etc.) can communicate meanings to other people. To start our discussion, we’re going to look at the three somatotypes.

Somatotypes

In the 1940s, psychologist and physician William Herbert Sheldon introduced the idea of somatotypes.²² In Sheldon’s theory, there were three overarching body types: the ectomorph, the endomorph, and the mesomorph. To figure out where you probably fit within Sheldon’s theory, complete Table 5.2, the Somatotyping Scale.

Instructions: For each statement, you will have three possible answers; choose the answer that most resembles who you are.

- _____1. If you attempt to encircle your right wrist with your left thumb and forefinger:
A) the two fingers do not touch
B) the two fingers meet
C) the two fingers overlap
- _____2. My body:
A) carries too much fat
B) is lean and muscular
C) is very skinny
- _____3. I would say that I am:
A) chubby
B) average
C) very thin
- _____4. I tend to be:
A) very inactive (sedentary)
B) fairly active
C) hyperactive
- _____5. I tend to:
A) overeat
B) eat a normal amount
C) eat anything I want and no gain weight
- _____6. When I go to a gym:
A) I am heavier than the people there
B) I look like the people there
C) I am much smaller than the people there
- _____7. With regards to gaining weight:
A) I am always trying to lose weight
B) I can gain and lose weight, but tend to stay around the same weight
C) I can't gain weight
- _____8. Strangers have told me that I should:
A) lose weight
B) stay the same, I look good
C) gain weight

- _____9. I think my metabolism is:
- A) too slow
 - B) just right
 - C) too fast
- _____10. My bone structure is:
- A) very large
 - B) large to medium
 - C) small to frail

Each letter corresponds with a specific somatotype. Add the number of times you answered each letter below.

(A) Endomorphy	(B) Mesomorphy	(C) Ectomorphy
----------------	----------------	----------------

Table 5.2 Somatotyping Scale

Now, the Somatotyping Scale is based on the general traits that the three different somatotypes possess. Most people are more familiar with their physical looks (Figure 5.5).

Now, you may be wondering to yourself, where did these three terms come from in the first place? Well, Sheldon created these terms from the three germ layers (three primary cell layers) of embryonic development:

- Endoderm (inner layer) - develops into the gastrointestinal tract
- Mesoderm (middle layer) - develops into the cardiovascular and muscular systems
- Ectoderm (outer layer) - develops into the skin and the nervous systems

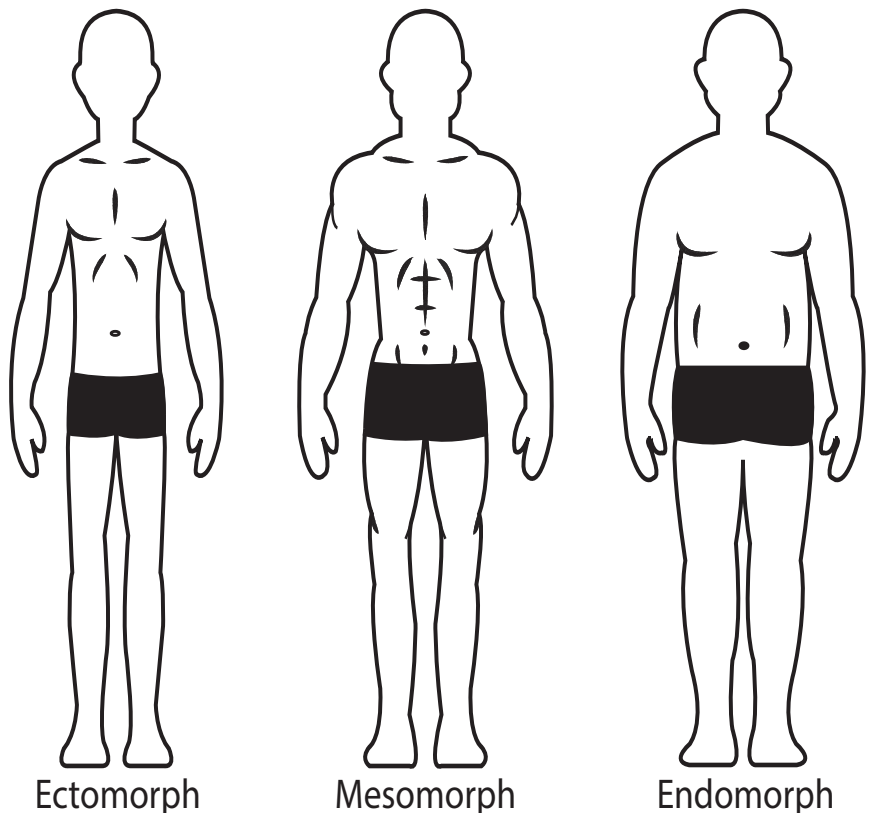

Figure 5.5 Sheldon's Somatotypes

In Sheldon's original theory, the different somatotypes also possessed unique personality traits. Table 5.3 contains the Somatotype Perception Scale. Take a second to complete the measure.

The Somatotype Perception Scale is just that, stereotypes that some people have associated with the three different body types.²³ However, the media often still portrays these stereotypes in television and

movies. As such, many people still have these stereotypes.

Physical Appearance and Society



Figure 5.6. The Rubenesque Woman
https://commons.wikimedia.org/wiki/File:Peter_Paul_Rubens_-_Woman_with_a_Mirror_-_WGA20336.jpg

Unfortunately, someone's physical appearance has been shown to impact their lives in a number of different ways:

- Physically attractive students are viewed as more popular by their peers.
- Physically attractive people are seen as smarter.
- Physically attractive job applicants are more likely to get hired.
- Physically attractive people make more money.
- Physically attractive journalists are seen as more likable and credible.
- Physically attractive defendants in a court case were less likely to be convicted, and if they were convicted, the juries recommended less harsh sentences.
- Taller people are perceived as more credible.
- People who are overweight are less likely to get job interviews or promotions.

Now, this list is far from perfect and doesn't necessarily take every possible scenario into account. Furthermore, there are some differences between females and males in how they perceive attraction and how they are influenced by attraction. Moreover, culture can play a large part in how physical

attractiveness impacts peoples' perceptions. For example, the classic example of how culture determines what is considered physically attractive stems from the paintings of Peter Paul Rubens (1577-1640), who is famous for his use of full-figured women as a depiction of physical ideals (see Figure 5.6).

In the United States today, most females and males that are portrayed in leading roles fall into the mesomorphic somatotype. There are examples of ectomorphic and endomorphic leading players, but the majority of people on television shows and in films are played by people who are mesomorphic body types. In fact, these trends tend to be seen in all of our major media in the United States (e.g., news, magazines, comic books, live theatre).

Body Positivity

There are groups in the United States that are attempting to help break down these walls within our society. For example, in the past few years, there has been a movement known as body positivity. In reality, the idea of body positivity isn't that new. In 1996, Connie Sobczak and Elizabeth Scott founded *The Body Positive*. In her 2014 book, *embody: Learning to Love Your Unique Body (And Quiet that Critical Voice)*, Connie Sobczak defined body positive as "a way of living that gives you permission to love,

care for, and take pleasure in your body throughout your lifespan. Struggles will inevitably occur, especially during times of transition or imbalance.”²⁴ Sobczak goes on to note that practicing body positivity “allows you to find what you need to live with as much self-love and balanced self-care as possible. Experiences of conflict and suffering become opportunities to learn what is required to further your growth so you can find greater contentment and peace.”²⁵ The Body Positive has created a basic model for body positivity that consists of five basic competencies: reclaim health, practice intuitive self-care, cultivate self-love, declare your authentic beauty, and build community (Figure 5.7).

Reclaim Health

The first competency of the Be Body Positive Model is reclaiming one’s health. For too long, the health care industry has consistently used someone’s body mass index as an indication of someone’s physical health. However, there is ample research that “measurements of physical activity and metabolic fitness, such as blood

pressure, blood lipids, and blood sugar levels, are far better indicators of physical health than body size.”²⁶ As such, reclaiming one’s health is realizing that the weight loss and diet industry is a profit-making machine that isn’t very effective. The weight loss and diet industry is estimated to be worth \$245.51 billion by 2022.²⁷ People spend a ton of money here even though the long-term effects of dieting are abysmal, with most people gaining back the weight they lost and adding some.^{28,29}

Now, this is not to say that people who are unhealthy should relish their ill-health. Instead, body positivity is about understanding that health isn’t a number. One number that is often used to declare someone’s “health” is their body mass index. You can calculate your own BMI using this [calculator from the National Institute of Health](#). Here are the general categories associated with explaining someone’s BMI:

- Underweight = <18.5
- Normal weight = 18.5-24.9
- Overweight = 25-29.9
- Obesity = 30-39
- Morbid Obesity = 40+

In reality, BMI doesn’t distinguish between fat and muscle, so many elite bodybuilders have BMIs



Figure 5.7 Five Competencies of the Be Body Positive Model

Instructions: For each row of personality descriptors, select the adjective that you think most represents you as a person.			
1.	Quiet	Strong	Best friend
2.	Worrisome	Fights	Kind
3.	Lonely	Cheats	Happy
4.	Sneaky	Argues	Helps others
5.	Afraid	Gets teased	Polite
6.	Sad	Sick	Brave
7.	Tired	Lazy	Good looking
8.	Weak	Sloppy	Extraverted
9.	Kind	Naughty	Brave
10.	Nervous	Mean	Assumes leadership
11.	Low pain tolerance	Dirty	Aggressive
12.	Introverted	Tired	Athletic
13.	Intelligent	Lies	High pain threshold
14.	Caring	Poor athlete	Immodest
15.	Tense	Humorous	Energetic
Add the number of personality descriptors circled in each column separately.			
Ectomorphy	Endomorphy	Mesomorphy	

Table 5.3 Somatotype Perception Scale

and others will never experience that euphoric feeling runners discuss. Other people can easily pack on muscle, while others can spend hours and hours in the gym and simply not see the type of growth they desire. Basically, our bodies are different and have inherent limitations on what they achieve. When people have unrealistic expectations for their body can (and should) look like and what their body can achieve, they are considered to have body dysmorphia. Before progressing further, take a moment and complete Table 5.4 (The Body Dysmorphia Short Form).

Cultivate Self-Love

that say they're obese when they have little to no body fat. It's even possible to have metabolically healthy obesity. According to Patrick J. Skerrett, Former Executive Editor of *Harvard Health*, metabolically healthy obesity includes the following factors:

- a waist size of no more than 40 inches for a man or 35 inches for a woman
- normal blood pressure, cholesterol, and blood sugar
- normal sensitivity to insulin
- good physical fitness³⁰

As such, the focus of reclaiming health isn't about a number on a scale, but about being healthy. Unfortunately, many people still have the stereotype in society associating fatness with sickness, which modern medicine knows isn't the case.

Practice Intuitive Self-Care

Intuitive care is learning to trust our bodies regarding both eating and exercise. It's about being attuned to our body and realizing what our body needs. It's not about limiting yourself to 800 calories a day or exercising for nine hours every day. Instead, it's about learning to listen to our bodies mindfully. Intuitive self-care is realizing that our bodies need food and exercise, so we need to listen to them and provide them what they need. At the same time, intuitive self-care realizes that this is going to look different for everyone. In other words, there is no perfect diet or exercise routine that will be beneficial for everyone. Some people get a "runners high,"

As we've discussed with mindfulness throughout this text, one of the problems many people face is an overly critical brain that seems to run non-stop. Cultivating self-love is about learning to make life-affirming choices and not listening to the non-stop vulture sitting on our shoulders. A lot of the practices we've discussed with mindfulness are in line with this idea of cultivating self-love.

Declare Your Own Authentic Beauty

Everyone is beautiful. Yet, we live in a society that places premiums on certain types of physical attributes that get labeled "physically attractive" or "beautiful." Declaring your own authentic beauty is about:

choosing to see and express ourselves just as we are—internal and external qualities combined. Exploring beauty through a body positive lens teaches us to have a dynamic, engaged relationship with the world around us. We honor our bodies as we pass through each developmental stage of life, which leads to true self-care because we don't confuse it with a desire to transform our physical selves to meet someone else's definition of beauty.³¹

Now, we do not deny that we are bombarded by messages in our society that dictate beauty standards, and it's hard to avoid these images and not let them impact how we evaluate our physical appearance. Learning to declare your authentic beauty is a process and not a process that's going to happen overnight. Instead, it's important to point out those vulture statements when we see them and label them for what they are. The more we start recognizing these vulture statements, the easier it will be to acknowledge our beauty.

Build Community

The last competency in the Be Body Positive Model is building a community of likeminded people who seek to build each other up instead of taking each other down. Many colleges and universities even have Be Body Positive groups on campus to help support each other as we all learn to be more body positive.

MINDFULNESS ACTIVITY

For this activity, we want you to think through the Be Body Positive Model within your own life. Answer the following questions:



1. How has the health care system failed you with regards to reclaiming your health? How can you take control and reclaim your health? What obstacles do you have in front of you? How can you overcome them?
2. How can you approach food and exercise from a position of self-care? Do you think you do this now? Why? If not, what is preventing you from thinking about food and exercise from this approach?
3. When was the last time you had a critical thought about your physical appearance? How did you respond to that thought? Was it from a position of self-love? If not, how could you have cultivated self-love in that moment?
4. What are five things that make you beautiful?
5. Do you have a group of people in your life that celebrate being body positive? If not, how could

you go about creating this circle for yourself?

The Matching Hypothesis

One obvious area where physical appearance plays a huge part in our day-to-day lives is in our romantic relationships. Elaine Walster and her colleagues coined the “matching hypothesis” back in the 1960s.^{32,33} The basic premise of the matching hypothesis is that the idea of “opposites attracting” really doesn’t pertain to physical attraction. When all else is equal, people are more likely to find themselves in romantic relationships with people who are perceived as similarly physically attractive.

In a classic study conducted by Shepherd and Ellis, the researchers took pictures of married couples and mixed up the images of the husbands and wives.³⁴ The researchers then had groups of female and male college students sort the images based on physical attraction. Not surprisingly, there was a positive relationship between the physical attractiveness of the husbands and the physical attractiveness of the wives.

Other physical appearance variables beyond just basic physical attractiveness have also been examined with regards to the matching hypothesis. A group of researchers led by Julie Carmalt found that matching also explained the dating habits of young people.³⁵ In their study, Carmalt et al. found that individuals who were overweight were less likely to date someone who was physically attractive.

Overall, research generally supports the matching hypothesis, but physical attractiveness is not the only variable that can impact romantic partners (e.g., socioeconomic status, education, career prospects). However, the matching hypothesis is a factor that impacts many people’s ultimate dating selection ability.

Research Spotlight



In a series of different studies, Shaw Taylor et al. tested the matching hypothesis. In one of the studies, the researchers collected the data for 60 females and 60 males on online dating platforms (we’ll refer to these 120 people as the initiators). They then used the site activity logs to collect information about who the initiators matched with on the dating website and whether those people responded. Based on this contact information, the researchers also collected the pictures of those people who were contacted, so the researchers collected 966 photos (527 female, 439 male). The physical attractiveness of the group of photos was evaluated on a scale of very unattractive (-3) to very attractive (+3) by people within the authors’ department.

Matching behavior (or swiping right) was not based on the initiator’s physical appearance. So, people often matched with others who were physically more attractive than them. However, people only tended to respond to initiators when their physical attractiveness was similar.

Shaw Taylor, L., Fiore, A. T., Mendelsohn, G. A., & Cheshire, C. (2011). “Out of my league”: A real-world test of the matching hypothesis. *Personality and Social Psychology Bulletin*, 37(7), 942–954. <https://doi.org/10.1177/0146167211409947>

Instructions: Please read each sentence carefully and indicate the extent to which you agree with each statement. Please use the scale below to rate the degree to which each statement applies to you.

Strongly Disagree 1	Disagree 2	Neutral 3	Agree 4	Strongly Agree 5
---------------------------	---------------	--------------	------------	---------------------

1. I often avoid having all or part of my body seen by others.

2. My sex life has not been affected by concerns related to my physical appearance.

3. I have avoided being seen by others because of my concerns related to my physical appearance.

4. I do not worry that my body isn't sufficiently lean or muscular.

5. I am comfortable showing my body in public situations.

6. I often eat alone because I don't want people to know how much or how little I am eating.

7. My self-esteem is not influenced by my weight.

8. I worry a lot about how I look.

9. I am generally not self-conscious of how I look when I am around others.

10. When people tell me that I look good, I generally think they are lying.

Scoring To compute your scores follow the instructions below:

Step One: Add scores for items 1, 3, 6, 8, & 10 _____

Step Two: Add scores for items 2, 4, 5, 7, & 9 _____

Step Three: Add 30 to Step 1. _____

Step Four: Subtract the score for Step two from the score for Step Three. _____

Interpreting Your Score

The average score for females on this measure is 27.64, so scores above 27.64 (25.66 for males) are high and indicate a higher degree of body dysmorphia, while those below 27.64 (25.66 for males) are lower degrees of body dysmorphia. This is a research measure and not a diagnostic one. If you think you may be someone suffering from body dysmorphia, we would highly encourage you to seek out help from a mental health professional who specializes in the care and treatment of body dysmorphia.

Reference

Wrench, J. S. (2001). *Intercultural communication: Power in context*. Tapestry Press.

Table 5.4 Body Dysmorphia Short Form

Key Takeaways

- Communication is multifaceted with the combination of verbal and nonverbal cues culminating in a richer communication experience.
- Vocal cues such as rate, pitch, and volume have an impact on whether communication is effective.
- Facial expressions and body movements enhance communication, but may detract from the effectiveness of communication.

Exercises

- List and define the categories of nonverbal communication. For each category, make a list of corresponding nonverbal behaviors that are discussed in this chapter and add to this list from your own experiences.
- Recall a situation in which you interacted with someone whose nonverbal behaviors stood out for positive reasons. Describe the situation and nonverbal behaviors. Why do you consider nonverbal behaviors to be positive?
- Recall a situation in which you interacted with an individual whose nonverbal behaviors detracted from the individual's ability to communicate effectively. Describe these nonverbal behaviors and suggest what the individual could do differently.

5.3 Improving your Nonverbal Skills

LEARNING OUTCOMES

1. Explain the areas of nonverbal communication that can be assessed and improved.
2. Discuss the importance of observation when it comes to improving nonverbal behaviors.
3. Understand that nonverbal communication is a skill that requires practice.

In this chapter, we've examined a wide range of issues related to nonverbal communication. But it's one thing to understand nonverbal communication and something completely different to communicate using nonverbal behaviors effectively. In this section, we're going to explore some ways that you can start to improve your nonverbal skills.

The Nonverbal Mindset

When it comes to effective communication, you need to develop an appropriate mindset towards nonverbal communication. First, individuals must be aware that nonverbal communication plays a significant role in creating meaning.

Second, individuals must believe nonverbal communication is important and impactful. Awareness of nonverbal communication without the belief that it is important can result in negative outcomes. For example, students in nonverbal communication begin to learn about the importance of clothing and general appearance in creating impressions. Some students “rebel” against the idea that appearance and clothing matter stating, “people should accept me no matter what I am wearing.” While this would be ideal, the fact of the matter is that humans size up other humans using visual cues in initial interactions.

Lastly, individuals can analyze their nonverbal communication. This can be accomplished in several ways. Individuals might observe the behavior of individuals who seem to be liked by others and to whom others are socially attracted. The individual should then compare the behaviors of the “popular” person to their own behaviors. What differences exist? Does the other individual smile more, make more or less eye contact, engage in more or less touch, etc.? Based on this comparison, individuals can devise a plan for improvement or perhaps no improvement is needed!

Nonverbal Immediacy

In addition to awareness of nonverbal communication, believing that nonverbal communication is important and analyzing one’s own behavior, individuals should be aware of nonverbal immediacy.

Immediacy is defined as physical and psychological closeness. More specifically, Mehrabian defines immediacy as behaviors increasing the sensory stimulation between individuals.³⁶ Immediacy behaviors include being physically oriented toward another, eye contact, some touch, gesturing, vocal variety, and talking louder. Immediacy behaviors are known to be impactful in a variety of contexts.

In instructional, organizational, and social contexts, research has revealed powerful positive impacts attributable to immediacy behaviors, including influence and compliance, liking, relationship satisfaction, job satisfaction, and learning, etc. In the health care setting, the positive outcomes of nonverbally immediate interaction are well documented: patient satisfaction,^{37,38} understanding of medical information,^{39,40} patient perceptions of provider credibility,⁴¹ patient perceptions of confidentiality,⁴² parent recall of medical directives given by pediatricians and associated cognitive learning,⁴³ affect for the provider,^{44,45} and decreased apprehension when communicating with a physician.⁴⁶ Individuals can increase their immediacy behaviors through practice!

Key Takeaways

- Voice, body movement, eye contact, and facial expression can be assessed and improved upon to become a more effective communicator.
- Successful communicators can be observed and modeled.
- Practicing nonverbal communication is no different from practicing other skills, such as playing an instrument or cooking.

Exercises

- Record your voice and listen to the recording several times. Use the questions included in the “analyze your voice” section of this chapter. Make a note of areas where you believe you are doing well and areas where you may need improvement. Ask a friend to listen to your voice and respond to the question for additional

- feedback.
- Video record a conversation between you and a friend/s. (Make sure everyone approves of being recorded.) As a group, review your facial expressions, body movements, and gestures. Discuss your nonverbal behavior as a group being certain to compliment areas of success and ask for constructive feedback if you are comfortable doing so.
 - Select a nonverbal specific behavior such as greeting through a wave or eye contact. Use this nonverbal behavior in a manner that is inconsistent with the accepted use of this nonverbal behavior. For example, avoid eye contact completely with a friend or kiss a friend on the cheek instead of simply saying hello. Make a note of your reaction as well as the reaction of your friend. (Be prepared to explain your behavior to your friend.)
 - Take an inventory of your nonverbal communication skills by answering the following questions. Do you believe nonverbal communication is important? Why or why not? Which subcategories of nonverbal communication are your strengths and weaknesses? How can you improve on these weaknesses?

Chapter Wrap-Up

In this chapter, we discussed the importance of nonverbal communication. To be an effective nonverbal communicator, it is necessary to understand that nonverbal communication conveys a tremendous amount of information. However, the meaning of nonverbal communication most often must be understood within the context of the interaction. There are very few nonverbal behaviors that can be understood outside of context.

This chapter also discusses the functions of nonverbal communication. Nonverbal communication serves many purposes and works to clarify the meaning of verbal communication. Verbal communication and nonverbal communication, in combination, increase the chances of stimulating accurate meaning in the minds of others. One without the other dilutes the effectiveness of each.

Finally, this chapter discusses the subcategories of nonverbal communication. The subcategories of nonverbal communication allow us to account for the multitude of cues sent between the sender and receiver. The human brain must account for cues resulting from eye contact, facial expressions, distance between sender and receiver, touch, sound, movement, and scent. Amazingly, the human brain processes all of these cues very quickly and with a high degree of accuracy.

End of Chapter

KEY TERMS

- Accent
- Affect Displays
- Attribution Error
- Complement
- Contradict
- Dysfluencies
- Emblems
- Eye Gaze
- Haptics
- Illustrators
- Inflection
- Intensity
- Kinesics
- Nonverbal Vocalization
- Oculesics
- Olfactics
- Paralanguage
- Pitch
- Proxemics
- Regulate
- Regulators
- Repeat
- Rhythm
- Substitute
- Tempo
- Timbre
- Verbal Surrogates
- Vocalics

REAL WORLD CASE STUDY

Addie was assigned a roommate for her freshman year in college. Addie noticed that her roommate didn't make much eye contact, avoided touch, and didn't smile very often. After a few weeks, Addie noticed that her roommate began to look at her more when talking and smiled when she came into the room. Meanwhile, Addie made friends in some of her classes and invited them to her room to study. Addie's roommate didn't look at anyone and didn't smile. Addie's friends complained that her roommate didn't like them and that she was a little strange.

What information might Addie provide to her friends to give them insight into Addie's behavior?

The roommate's nonverbal behavior may have consequences for her in social settings. Is it her responsibility to adapt her nonverbal communication or the responsibility of those around her to try to understand that she is simply different?

END OF CHAPTER QUIZ

1. If Mary stomps her foot while saying, “No, I won’t go with you.” Which function of nonverbal communication is she using?
 - a. Complementing
 - b. Accenting
 - c. Repeating
 - d. Contradicting
 - e. Substituting
2. Ronnie says “ummm” frequently when speaking. This aspect of vocalics is referred to as _____.
 - a. Pitch
 - b. Rate
 - c. Disfluency
 - d. Disconnection
 - e. Pause
3. Choose the best example of an emblem.
 - a. Using two fingers in the shape of a V to sign “Peace”
 - b. Shaking of the head to say no
 - c. Pointing in the air while saying up
 - d. Rubbing your stomach while saying yum
 - e. Making a cradle with the arms when saying baby
4. What is the difference in the repeating function of nonverbal communication and the complementing function of nonverbal communication?
 - a. Complementing nonverbal behavior can stand alone, whereas repeating cannot.
 - b. Repeating nonverbal communication can stand alone, whereas complementing cannot.
 - c. Repeating behaviors are more useful than complementing nonverbal communication.
 - d. There is no difference between complementing and repeating nonverbal behavior.
 - e. Repeating behaviors are more culturally appropriate in the U.S.
5. Which function of nonverbal communication is best represented when the nonverbal behavior is the opposite of verbal communication?
 - a. Complementing
 - b. Repeating
 - c. Accenting
 - d. Substituting
 - e. Contradicting
6. _____ is the study of how use of space communicates.
 - a. Haptics
 - b. Oculesics
 - c. Chronemics
 - d. Proxemics
 - e. Kinesics
7. _____ is the study of how touch communicates.
 - a. Haptics
 - b. Oculesics
 - c. Chronemics
 - d. Proxemics
 - e. Kinesics
8. If Lacey is standing within 18 inches of her friend, she is standing in which of Hall’s distances?
 - a. Personal
 - b. Intimate
 - c. Social
 - d. Public
 - e. Parallel

References

- 1 Eckman, P and Friesen, W.V. (1969). Head and body cues in the judgement of emotion: A reformulation. *Perceptual and Motor Skills*, 24, 711-724.
- 2 Satell, G. (Feb 6, 2015). *Why communication is today's most important skill*. Retrieved on December 1, 2018 <https://www.forbes.com/sites/gregsatell/2015/02/06/why-communication-is-todays-most-important-skill/#768491331100>
- 3 Ross, L. (1977). "The intuitive psychologist and his shortcomings: Distortions in the attribution process". In Berkowitz, L. *Advances in experimental social psychology*. 10. Academic Press. pp. 173–220.
- 4 Mehrabian, A. (1971). *Silent messages*. Wadsworth.
- 5 Birdwhistell, R. L. (1970). *Kinesics and context: Essays in body motion communication*. University of Pennsylvania Press, p. xiv.
- 6 Philpott, J. S. (1983). *The relative contribution to meaning of verbal and nonverbal channels of communication: A meta-analysis*. Unpublished master's thesis. University of Nebraska.
- 7 Dolcos, S., Sung, K., Argo, J. J., Flor-Henry, S., & Dolcos, F. (2012). The power of a handshake: Neural correlates of evaluative judgments in observed social interactions. *Journal of Cognitive Neuroscience*, 24(12), 2292-2305. https://doi.org/10.1162/jocn_a_00295; pg. 2303.
- 8 Punyanunt-Carter, N. M., & Wrench, J. S. (2009). Development and validity testing of a measure of touch deprivation. *Human Communication*, 12, 67-76.
- 9 Napper, L. E., Montes, K. S., Kenney, S. R., & LaBrie, J. W. (2016). Assessing the personal negative impacts of hooking up experienced by college students: Gender differences and mental health. *The Journal of Sex Research*, 53(7), 766-775. <https://doi.org/10.1080/00224499.2015.1065951>
- 10 Eckman, P and Friesen, W.V. (1969). *Head and body cues in the judgement of emotion: A reformulation*. *Perceptual and Motor Skills*, 24, 711-724.
- 11 Sacco, D. F., & Brown, M. (2018). Preferences for facially communicated big five personality traits and their relation to self-reported big five personality. *Personality & Individual Differences*, 134, 195–200. <https://doi.org/10.1016/j.paid.2018.06.024>
- 12 Bente, G., Donaghy, W. C., & Suwelack, D. (1998). Sex differences in body movement and visual attention: An integrated analysis of movement and gaze in mixed-sex dyads. *Journal of Nonverbal Behavior*, 22(1), 31–58. <https://doi.org/10.1023/A:1022900525673>
- 13 Knapp, M. L., & Hall, J. A. (2002). *Nonverbal communication in human interaction*. Thomson Learning.
- 14 Burgoon, J. K., Buller, D. B., & Woodall, W. G. (1996). *Nonverbal Communication*. McGraw-Hill.
- 15 Ibid.
- 16 Poyatos, F. (2002). *Nonverbal communication across disciplines*. (Volume 1: Culture, sensory interaction, speech conversation). John Benjamins.
- 17 Goldin-Meadow, S. (2005). The two faces of gesture: Language and thought. *Gesture*, 5(1-2), 241-257. <https://doi.org/https://doi.org/10.1075/gest.5.1.16gol>
- 18 Hall, E.T. (1969). *The hidden dimension*. Doubleday.
- 19 Bruneau, Thomas J. (1980). Chronemics and the verbal-nonverbal interface. In M. R. Key (Ed.), *The relationship of verbal and nonverbal communication* (pp. 101-119). Mouton Press.
- 20 *U.S. air fresheners market analysis by product type (aerosol/spray, electric air fresheners, gels, candles, others) by application (residential, commercial, cars, others), competitive analysis and segment forecasts, 2018 – 2025*. Accessed December 1, 2018 <https://www.grandviewresearch.com/industry-analysis/us-air-fresheners-market>
- 21 Ivy, D. K., & Wahl, S. T. (2019). *Nonverbal communication for a lifetime* (3rd ed.). Kendall-Hunt; pg. 155.
- 22 Sheldon, W. H. (1940). *The varieties of human physique*. Harper and Brothers.
- 23 Ryckman, R. M., Robbins, M. A., Kaczor, L. M., & Gold, J. A. (1989). Male and female raters' stereotyping of male and female physiques. *Personality and Social Psychology Bulletin*, 15(2), 244–251. <https://doi.org/10.1177/0146167289152011>
- 24 Sobczak, C. (2014). *embody: Learning to love your unique body (and quiet that critical voice)*. Gürze; pg.

18. <https://tinyurl.com/sarp4mq>
- 25 Ibid., pgs. 18-19.
- 26 Ibid. pg. 23.
- 27 Markets & Markets. (2017, October). *Weight loss and weight management market by equipment (surgical equipment (biliopancreatic diversion, gastric bypass), fitness (treadmill, elliptical, stair stepper)), diet (meal, beverage, supplement) and weight loss services - global forecast to 2022*. Retrieved February 16, 2020: <https://tinyurl.com/sdedpls>
- 28 Mann, T., Tomiyama, A. J., Westling, E., Lew, A.-M., Samuels, B., & Chatman, J. (2007). Medicare's search for effective obesity treatments: Diets are not the answer. *American Psychologist*, 62(3), 220–233. <https://doi.org/10.1037/0003-066X.62.3.220>
- 29 Dombrowski, S. U., Knittle, K., Avenell, A., Araújo-Soares, V., & Sniehotta, F. F. (2014). Long term maintenance of weight loss with non-surgical interventions in obese adults: systematic review and meta-analyses of randomised controlled trials. *BMJ : British Medical Journal*, 348, g2646. <https://doi.org/10.1136/bmj.g2646>
- 30 Skerrett, P. J. (2013, September 24). Overweight and healthy: the concept of metabolically healthy obesity. *Harvard Health Publishing*. <https://tinyurl.com/yxxtfsvm>
- 31 Sobczak, C. (2014). *embody: Learning to love your unique body (and quiet that critical voice)*. Gürze; pg. 81. <https://tinyurl.com/sarp4mq>
- 32 Walster, E., Aronson, V., Abrahams, D., & Rottman, L. (1966). Importance of physical attractiveness in dating behavior. *Journal of Personality and Social Psychology*, 4(5), 508–516. <https://doi.org/10.1037/h0021188>
- 33 Berscheid, E., Dion, K., Walster, E., & Walster, G. W. (1971). Physical attractiveness and dating choice: A test of the matching hypothesis. *Journal of Experimental Social Psychology*, 7(2), 173–189. [https://doi.org/10.1016/0022-1031\(71\)90065-5](https://doi.org/10.1016/0022-1031(71)90065-5)
- 34 Shepherd, J. W., & Ellis, H. D. (1972). Physical attractiveness and selection of marriage partners. *Psychological Reports*, 30(3), 1004. <https://doi.org/10.2466/pr0.1972.30.3.1004>
- 35 Carmalt, J. H., Cawley, J., Joyner, K., & Sobal, J. (2008). Body weight and matching with a physically attractive romantic partner. *Journal of Marriage and Family*, 70(5), 1287-1296. <https://doi.org/10.1111/j.1741-3737.2008.00566.x>
- 36 Mehrabian, A. (1972). *Nonverbal communication*. Aldine Publishing Company.
- 37 Richmond, V. P., Smith, R. S., Heisel, A. D., & McCroskey, J. C. (2001). Nonverbal immediacy in the patient/physician relationship. *Communication Research Reports*, 18(3), 211-216. <https://doi.org/10.1080/08824090109384800>
- 38 LaBelle, S., Odenweller, K.G., Myers, S.A. (2015). Applying instructor communication behaviors and learning outcomes to the pediatrician-parent context. *Southern Communication Journal*, 80(1), 55-73. <https://doi.org/10.1080/1041794X.2014.981284>.
- 39 Conlee, C. J., Olvera, J., & Vagim, N. N. (1993). The relationships among physician nonverbal immediacy and patient satisfaction with hospital care: Results of an analysis with a novel instrumental variable. *Health Research and Educational Trust*, 43(5), 1505-1519. <https://doi.org/10.1111/j.1475-6773.2008.00849.x>
- 40 Wanzer, M. B., Booth-Butterfield, M., & Gruber, K. (2004). Perceptions of health care providers' communication: Relationships between patient-centered communication and satisfaction. *Health Communication*, 16(3), 363-384. https://doi.org/10.1207/S15327027HC1603_6
- 41 Paulsel, M. L., McCroskey, J. C., & Richmond, V. P. (2006). Perceptions of health care professionals' credibility as a predictor of patients' satisfaction with their medical care and physician. *Communication Research Reports*, 23(2), 69-76. <https://doi.org/10.1080/08824090600668832>
- 42 Paulsel, M. L., Richmond, V. P., McCroskey, J. C., & Cayanus, J. L. (2005). The relationships of perceived health professionals' communication traits and credibility with perceived patient confidentiality. *Communication Research Reports*, 22(2), 129-142. <https://doi.org/10.1080/00036810500130588>
- 43 LaBelle, S., Odenweller, K. G., & Myers, S. A. (2015). Applying instructor communication behaviors and learning outcomes to the pediatrician-parent context. *Southern Communication Journal*, 80(1), 55-73. <https://doi.org/10.1080/1041794X.2014.981284>

44 Ibid.

45 Richmond, V. P., Smith, R. S., Heisel, A. D., & McCroskey, J. C. (2001). Nonverbal immediacy in the patient/physician relationship. *Communication Research Reports*, 18(3), 211-216. <https://doi.org/10.1080/08824090109384800>

46 Ibid.

END OF CHAPTER QUIZ

ANSWER KEY

1) B 2) C 3) A 4) B 5) E 6) D 7) A 8) A

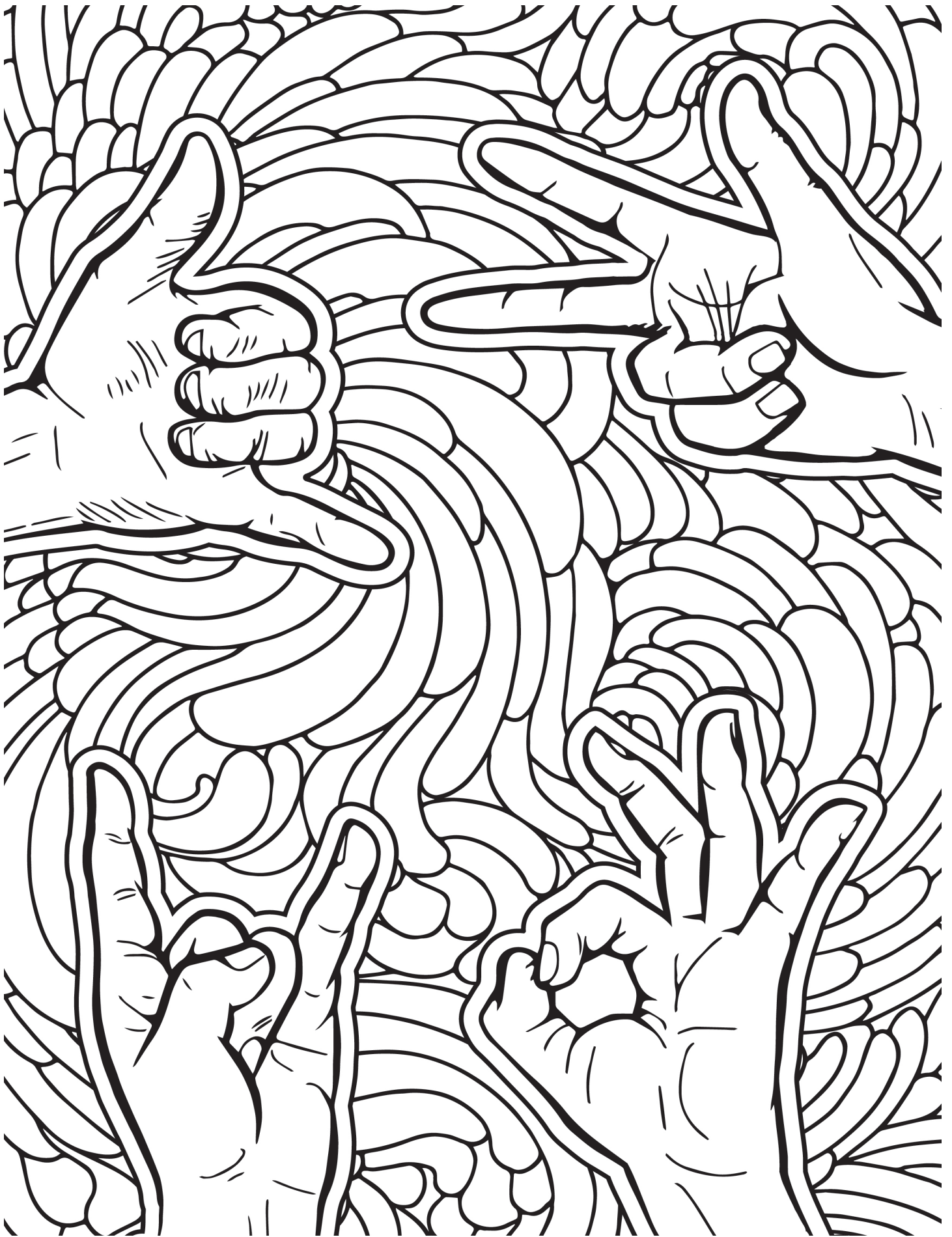

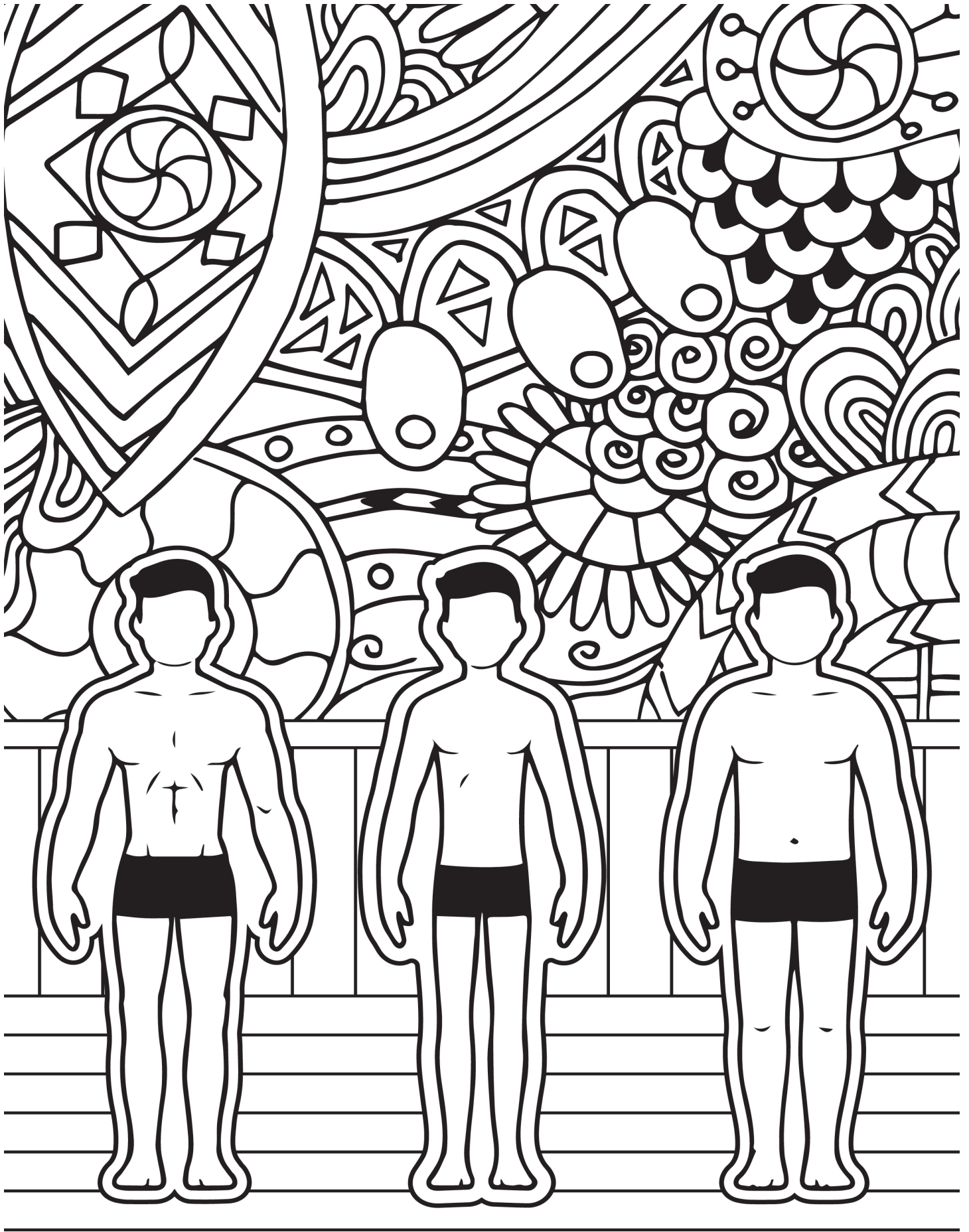



Image by [Mikkel Wejdemann](#) from [Pixabay](#)

Chapter 6

Cultural and Environmental Factors in Interpersonal Communication

One of the most important factors in our understanding of communication is culture. Every one of us has grown up in a unique cultural environment, and this culture has impacted how we communicate. Culture is such an ingrained part of who we are that we often don't even recognize our own culture. In this chapter, we're going to explore culture and its impact on interpersonal communication.



Figure 6.1 Traditional costumes and contemporary style of dress are elements of culture. *Traditional Dresses of Kashmir.* By Azad888. This file is licensed under the [Creative Commons Attribution 3.0 Unported](https://creativecommons.org/licenses/by/3.0/) license.

6.1 What is Culture?

LEARNING OUTCOMES

1. Define the term “culture” as it is used within this book.
2. Understand a dominant culture.
3. Differentiate between a co-culture and a microculture.

When people hear the word “culture,” many different images often come to mind. Maybe you immediately think of going to the ballet, an opera, or an art museum. Other people think of traditional dress like that seen from Kashmir in Figure 6.1. However, the word “culture” has a wide range of different meanings to a lot of different people. For example, when you travel to a new country (or even a state within your own country), you expect to encounter different clothing, languages, foods, rituals, etc.... The word “culture” is a hotly debated term among academics. In 1952, A. L. Kroeber and Clyde Kluckhohn compiled a list of 164 definitions for the word “culture.” Culture is often described as “the way we do things.”¹ In their book, the authors noted, “Considering that concept [of culture] has had a name for less than 80 years, it is not surprising that full agreement and precision has not yet been attained.”² Kroeber and Kluckhohn predicted that eventually, science would land on a singular definition of culture as it was refined through the scientific process over time. Unfortunately, the idea of a single definition of culture is no closer to becoming a reality today than it was in 1952.³

For our purposes, we are going to talk about **culture** as “a group of people who through a process

of learning are able to share perceptions of the world which influences their beliefs, values, norms, and rules, which eventually affect behavior.”⁴ Let’s break down this definition. First, when we talk about “culture,” we are starting off with a group of people. One of the biggest misunderstandings new people studying culture have is that an individual can have their own personalized culture. Culture is something that is formed by the groups that we grow up in and are involved with through our lifetimes.

Second, we learn about our culture. In fact, culture becomes such an ingrained part of who we are that we often do not even recognize our own culture and how our own culture affects us daily. Just like language, everyone is hardwired to learn culture. What culture we pick up is ultimately a matter of the group(s) we are born into and raised. Just like a baby born to an English-speaking family isn’t going to magically start speaking French out of nowhere, neither will a person from one culture adopt another culture accidentally.

Third, what we learn ultimately leads to a shared perception of the world. All cultures have stories that are taught to children that impact how they view the world. If you are raised by Jewish or Christian parents/guardians, you will learn the creation story in the Bible. However, this is only one of many different creation myths that have abounded over time in different cultures:

- The Akamba in Kenya say that the first two people were lowered to earth by God on a cloud.
- In ancient Babylon and Sumeria, the gods slaughtered another god named We-ila, and out of his blood and clay, they formed humans.
- One myth among the Tibetan people is that they owe their existence to the union of an ogress, not of this world, and a monkey on Gangpo Ri Mountain at Tsetang.
- And the Aboriginal tribes in Australia believe that humans are just the decedents of gods.⁵

Ultimately, which creation story we grew up with was a matter of the culture in which we were raised. These different myths lead to very different views of the individual’s relationship with both the world and with their God, gods, or goddesses.

Fourth, the culture we are raised in will teach us our beliefs, values, norms, and rules. **Beliefs** are assumptions and convictions held by an individual, group, or culture about the truth or existence of something. For example, in all of the creation myths discussed in the previous paragraph, these are beliefs that were held by many people at various times in human history. Next, we have **values**, or important and lasting principles or standards held by a culture about desirable and appropriate courses of action or outcomes. This definition is a bit complex, so let’s break it down. When looking at this definition, it’s important first to highlight that different cultures have different perceptions related to both courses of action or outcomes. For example, in many cultures throughout history, martyrdom (dying for one’s cause) has been something deeply valued. As such, in those cultures, putting one’s self in harm’s way (course of action) or dying (outcome) would be seen as both desirable and appropriate. Within a given culture, there are generally guiding principles and standards that help determine what is desirable and appropriate. In fact, many religious texts describe martyrdom as a holy calling. So, within these cultures, martyrdom is something that is valued. Next, within the definition of culture are the concepts of norms and rules. **Norms** are informal guidelines about what is acceptable or proper social behavior within a specific culture. **Rules**, on the other hand, are the explicit guidelines (generally written down) that govern acceptable or proper social behavior within a specific culture. With rules, we have clearly concrete and explicitly communicated ways of behaving, whereas norms are generally not concrete, nor are they explicitly communicated. We generally do not know a norm exists within a given culture unless we violate the norm or watch someone else violating the norm. The final part of the definition of culture, and probably the most important for our purposes, looking at interpersonal communication, is that these beliefs, values, norms, and rules will govern how people behave.

Co-cultures

In addition to a dominant culture, most societies have various **co-cultures**—regional, economic, social, religious, ethnic, and other cultural groups that exert influence in society. Other co-cultures develop among people who share specific beliefs, ideologies, or life experiences. For example, within the United States we commonly refer to a wide variety of different cultures: Amish culture, African American culture, Buddhist Culture, and lesbian, gay, bisexual, transgender, queer, intersexed, and asexual (LGBTQIA+) culture. With all of these different cultural groups, we must realize that just because individuals belong to a cultural group, that does not mean that they are all identical. For example, African Americans in New York City are culturally distinct from those living in Birmingham, Alabama, because they also belong to different geographical co-cultures. Within the LGBTQIA culture, the members who make up the different letters can have a wide range of differing cultural experiences within the larger co-culture itself. As such, we must always be careful to avoid generalizing about individuals because of the co-cultures they belong to.

Co-cultures bring their unique sense of history and purpose within a larger culture. Co-cultures will also have their holidays and traditions. For example, one popular co-cultural holiday celebrated in the United States is Cinco de Mayo. Many U.S. citizens think that Cinco de Mayo is a Mexican holiday. However, this is not a Mexican holiday. Outside of Puebla, Mexico, it's considered a relatively minor holiday even though children do get the day off from school. One big mistake many U.S. citizens make is assuming *Cinco de Mayo* is Mexican Independence Day, which it is not. Instead, *El Grito de la Independencia* (The Cry of Independence) is held annually on September 16 in honor of Mexican Independence from Spain in 1810. Sadly, *Cinco de Mayo* has become more of an American holiday than it is a Mexican one. Just as an FYI, *Cinco de Mayo* is the date (May 5, 1862) observed to commemorate the Mexican Army's victory over the French Empire at the Battle of Puebla that conclude the Franco-Mexican War (also referred to as the Battle of Puebla Day). We raise this example because often the larger culture coopts parts of a co-culture and tries to adapt it into the mainstream. During this process, the meaning associated with the co-culture is often twisted or forgotten. If you need another example, just think of St. Patrick's Day, which evolved from a religious celebration marking the death of St. Patrick on March 17, 461 CE, to a day when "everyone's Irish" and drinks green beer.

Microcultures

The last major term we need to explain with regards to culture is what is known as a microculture. A **microculture**, sometimes called a local culture, refers to cultural patterns of behavior influenced by cultural beliefs, values, norms, and rules based on a specific locality or within an organization. "Members of a microculture will usually share much of what they know with everyone in the greater society but will possess a special cultural knowledge that is unique to the subgroup."⁶ If you're a college student and you've ever lived in a dorm, you may have experienced what we mean by a microculture. It's not uncommon for different dorms on campus to develop their own unique cultures that are distinct from other dorms. They may have their own exclusive stories, histories, mascots, and specializations. Maybe you live in a dorm that specializes in honor's students or pairs U.S. students with international students. Perhaps you live in a dorm that is allegedly haunted. Maybe you live in a dorm that values competition against other dorms on campus, or one that doesn't care about the competition at all. All of these examples help individual dorms develop unique cultural identities.

We often refer to microcultures as "local cultures" because they do tend to exist among a small segment of people within a specific geographical location. There's quite a bit of research on the topic of

classrooms as microcultures. Depending on the students and the teacher, you could end up with radically different classroom environments, even if the content is the same. The importance of microcultures goes back to Abraham Maslow's need for belonging. We all feel the need to belong, and these microcultures give us that sense of belonging on a more localized level.

For this reason, we often also examine microcultures that can exist in organizational settings. One common microculture that has been discussed and researched is the Disney microculture. Employees (oops! We mean cast members) who work for the Disney company quickly realize that there is more to working at Disney than a uniform and a name badge. Disney cast members do not wear uniforms; everyone is in costume. When a Disney cast member is interacting with the public, then they are "on stage;" when a cast member is on a break away from the public eye, then they are "backstage." From the moment a Disney cast member is hired, they are required to take Traditions One and probably Traditions Two at Disney University, which is run by the Disney Institute (<http://disneyinstitute.com/>). Here is how Disney explains the purpose of Traditions: "Disney Traditions is your first day of work filled with the History & Heritage of The Walt Disney Company, and a sprinkle of pixie dust!"⁷ As you can tell, from the very beginning of the Disney cast member experience, Disney attempts to create a very specific microculture that is based on all things Disney.

Key Takeaways

- Over the years, there have been numerous definitions of the word culture. As such, narrowing down to only one definition of the term is problematic, no matter how you define "culture." For our purposes, we define culture as a group of people who, through a process of learning, can share perceptions of the world, which influences their beliefs, values, norms, and rules, which eventually affect behavior.
- In the realm of cultural studies, we discuss three different culturally related terms. First, we have a dominant culture, or the established language, religion, behavior, values, rituals, and social customs of a specific society. Within that dominant culture will exist numerous co-cultures and microcultures. A co-culture is a regional, economic, social, religious, ethnic, or other cultural groups that exerts influence in society. Lastly, we have microcultures or cultural patterns of behavior influenced by cultural beliefs, values, norms, and rules based on a specific locality or within an organization.

Exercises

- Think about your own dominant culture. What does it mean to be a member of your national culture? What are the established language, religion, behavior, values, rituals, and social customs within your society?
- Make a list of five co-cultural groups that you currently belong to. How does each of these different co-cultural groups influence who you are as a person?
- Many organizations are known for creating, or attempting to create, very specific microcultures. Thinking about your college or university, how would you explain your microculture to someone unfamiliar with your culture?

6.2 The Function of Culture

LEARNING OUTCOMES

1. Explain the concept of collective self-esteem.
2. Define the term “stereotype” and explain its implications for interpersonal communication.
3. Summarize the implications of ethnocentrism in interpersonal communication.

Collective Self-Esteem

Henri Tajfel originally coined the term “collective self” as “that aspect of an individual’s self-concept which derives from his knowledge of his membership in a social group (or groups) together with the value and emotional significance attached to that membership.”⁸ Jennifer Crocker and Riia Luhtanen took Tajfel’s ideas one step further and discussed them as an individual’s **collective self-esteem**, or the aspect of an individual’s self-worth or self-image that stems from their interaction with others and evaluation of their various social groups.⁹ Based on their research, Crocker and Luhtanen found four different factors related to an individual’s collective self-esteem: private collective esteem, membership esteem, public collective esteem, and importance to identity.

The first factor of collective self-esteem is the individual’s **private collective esteem**, or the degree to which an individual positively evaluates their group. Every individual belongs to a wide range of groups, and we can evaluate these groups as either positive or negative. Imagine you’ve been brought up in a community where gang membership is a very common practice. You may have been forced into gang life at a very early age. Over time, you may start to see a wide array of problems with gangs, so you may start to devalue the group. In this case, you would have low private collective esteem.

The second factor of collective self-esteem is **membership esteem**, which is the degree to which an individual sees themselves as a “good” member of a group. Maybe you’ve belonged to a religious organization your entire life. Over time, you start to find yourself wondering about the organization and your place within the organization. Maybe you see yourself as having ideas and opinions that are contrary to the organization, or maybe your behavior when not attending religious services is not what the organization would advocate. In this case, you may start to see yourself as a “bad” member of this organization, so your membership esteem would be lower than someone who sees themselves as a “good” member of this organization.

The third factor of collective self-esteem is **public collective self-esteem**, or the degree to which nonmembers of a group evaluate a group and its members either positively or negatively. Maybe you’re a lesbian college student at a very progressive institution where students overwhelmingly support LGBTQIA rights. In this case, the collective views the group that you belong to positively.

The final factor of collective self-esteem is **importance to identity**, or the degree to which group membership is important to an individual. As mentioned earlier, we all belong to a wide range of cultural groups. Some of these groups are near and dear to us, while others are ones we don’t think about very often, so they just aren’t very important to us. For example, if you’re someone who has always lived in Charleston, South Carolina, then being a member of the Southerner cultural group may

be a very important part of your identity. If you ended up leaving the south and moving to Oregon, this “southerner” label may take on even more meaning for you and become an even stronger identity marker because your immediate cultural group no longer surrounds you.

There has been a wealth of research conducted on the importance of collective self-esteem on individuals. For example, if you compare your cultural groups as being better than other cultural groups, then you will experience more positive emotions and self-evaluations.¹⁰ However, the opposite is also true. Individuals who compare their cultural groups to those cultural groups that are perceived as “better-off,” tend to experience more negative emotions and lower self-evaluations. As you can imagine, an individual who is a member of a group that is generally looked down upon by society will have a constant battle internally as they battle these negative emotions and subsequent lower self-evaluations because of membership within a cultural group.

You may be wondering how this ultimately impacts interpersonal communication. Research has examined how an individual’s collective self-esteem impacts their interpersonal interactions.¹¹ The researchers found that “during interactions in which multicultural persons felt that their heritage culture was being positively evaluated, they were more likely to perceive the interaction as intimate, they disclosed more and perceived their interaction partner as more disclosing, they enjoyed the interaction more, and they were more likely to indicate that they felt personally accepted.”¹² Furthermore, individuals with high collective self-esteem generally had more favorable interactions with people of differing cultures. On the other hand, individuals who had low levels of public collective self-esteem tended to recall less intimate social interactions with people from different cultures. As you can see, cultural self-esteem is an essential factor in our intercultural interactions with other people. For this reason, understanding how we view our cultural identities becomes very important because it can predict the types of intercultural interactions we will ultimately have.

Stereotyping

Stereotypes are “a set of beliefs about the personal attributes of a social group.”¹³ Many people immediately hear the word “stereotype” and cringe because it’s often filled with negative connotations. However, not all stereotypes are necessarily wrong or bad. Some stereotypes exist because they are accurate.¹⁴ Often groups have real differences, and these differences are not bad or wrong; they just are. Let’s look at a real stereotype that plays out. When people hear the words “flight attendant,” they generally associate females with the term. In fact, in the 1980s only 19% of flight attendants were male, and today 26% of flight attendants are male.¹⁵ Are all flight attendants female? Obviously, not; however, the majority of flight attendants are female. We call these types of jobs sex-segregated because the jobs are held overwhelmingly by one biological sex or the other when there is no real reason why either sex cannot be effective within the job. However, many also hold the stereotype that flight attendants are all young. Although this was historically true, the ages of flight attendants has changed: 16-24 year olds (4.9%), 25-34 year olds (16.8%), 35-44 year olds (29.7%), 45-54 year olds (28.2%), and 55+ year olds (21.4%).

As you can see, the overwhelming majority of flight attendants are 35 years of age or older. Almost half of flight attendants today are over 45 years of age. In this case, the stereotype of the young flight attendant simply doesn’t meet up with reality.

Furthermore, there can be two distinctly different types of stereotypes that people hold: cultural and personal. Cultural stereotypes are beliefs possessed by a larger cultural group about another social group, whereas personal stereotypes are those held by an individual and do not reflect a shared belief with their

cultural group(s). In the case of cultural stereotypes, cultural members share a belief (or set of beliefs) about another cultural group. For example, maybe you belong to the Yellow culture and perceive all members of the Purple culture as lazy. Often these stereotypes that we have of those other groups (e.g., Purple People) occur because we are taught them since we are very young. On the other hand, maybe you had a bad experience with a Purple Person being lazy at work and in your mind decide all Purple People must behave like that. In either case, we have a negative stereotype about a cultural group, but how we learn these stereotypes is very different.

Now, even though some stereotypes are accurate and others are inaccurate, it does not mitigate the problem that stereotypes cause. Stereotypes cause problems because people use them to categorize people in snap judgments based on only group membership. Going back to our previous example, if you run across a Purple person in your next job, you'll immediately see that person as lazy without having any other information about that person. When we use blanket stereotypes to make *a priori* (before the fact) judgments about someone, we distance ourselves from making accurate, informed decisions about that person (and their cultural group). Stereotypes prejudice us to look at all members of a group as similar and to ignore the unique differences among individuals. Additionally, many stereotypes are based on ignorance about another person's culture.

Try this exercise: picture someone named Mel. OK, now picture someone named Hillary. What did the people you pictured look like? The immediate impressions we get in our minds occur because of stereotypes we associate with these words. One of our authors has a cousin named Melanie, who is often called Mel by the family, and our coauthor had a close friend in college, who was a male, named Hillary. This simple exercise demonstrates how often and easy it is for stereotypes to enter into our heads.

Culture as Normative

Another function of culture is that it helps us establish norms. Essentially, one's culture is normative,¹⁶ or we assume that our culture's rules, regulations, and norms are correct and those of other cultures are deviant, which is highly ethnocentric. The term **ethnocentrism** can be defined as the degree to which an individual views the world from their own culture's perspective while evaluating other cultures according to their own culture's preconceptions, often accompanied by feelings of dislike, mistrust, or hate for cultures deemed inferior. All of us live in a world where we are raised in a dominant culture. As a result of being raised in a specific dominant culture, we tend to judge other cultures based on what we've been taught within our own cultures. We also tend to think our own culture is generally right, moral, ethical, legal, etc. When a culture appears to waiver from what our culture has taught is right, moral, ethical, legal, etc., we tend to judge those cultures as inferior.

One of our coauthor's favorite examples of the problem of ethnocentrism comes from the MTV television show *Road Rules: The Quest*. In one episode, one of the contestants, Ellen, is walking around in Marrakech, Morocco, wearing very short shorts. In an Islamic country where a woman wearing revealing clothing is a violation of Islamic law, Ellen was violating the culture's dress code. To this end, some of the villagers in Marrakech took it upon themselves to correct Ellen's nonverbal behavior by throwing rocks at her. Of course, Ellen just couldn't understand why these male villagers were throwing rocks at her. Although throwing rocks at another person should be viewed as universally inappropriate, Ellen's ethnocentric behavior and complete lack of understanding of Muslim countries were also inappropriate. Ellen was walking around in a foreign country and was completely unaware that she presented herself in public was seen as an insult to Allah and society. Admittedly, this episode aired in July 2001, so we were just a few short months before 9-11 and the public awakening to a whole range of issues occurring in the

Why America?

The term “America” is thought to have been a mistake made by a cartographer in 1507 named Martin Waldseemüller, a cleric in the cathedral village of St.-Dié, France. Martin created what is considered to be the “birth certificate of America” by creating a map charting what was the known world at the time. You can view this map on the U.S. Library of Congress’ website (<http://www.loc.gov/resource/g3200.ct000725/>).

When looking at this map, look to the bottom left-hand side of the map; you will see the inscription “America.” This label was assigning credit for finding South America to Amerigo Vespucci instead of Christopher Columbus.

Middle East.

At the same time, ethnocentrism isn’t 100% a horrible thing either. Shortly after 9-11, a flag shortage occurred in the United States because people wanted to display our unity and pride during those horrible days after the atrocities that occurred on U.S. soil. Patriotism is a more mild form of ethnocentrism. The fact that we view ourselves as “American” is even somewhat ethnocentric because technically there are three rather large countries that are all in North America and 13 in South America. By definition, we’re all Americans. However, U.S. citizens have clung to the title “American” without ever giving thought to those other countries that exist on these two continents. Here’s another interesting fact. I was recently surfing the Internet looking for uses of the word “American” for this chapter. Here is one I found from a protestor in Alabama, “We live in America. We speak American.” I’ll give the speaker the benefit of the doubt and believe she meant we speak English, which is true for the majority of citizens in the United States (78.1% according to U.S. Census data from 2021, <https://data.census.gov/cedsci/>). However, more people in North and South America do not speak English when compared to those who do.

Key Takeaways

- Collective self-esteem is an individual’s self-worth or self-image that stems from their interaction with others and evaluation of their various social groups. Some groups we hold tightly to, while we only see ourselves as peripherally associated with others. Research has shown that there are four significant parts to collective self-esteem: private collective esteem (positive or negative evaluation you have a group), membership esteem (the degree to which you see yourself as a “good” member of a group), public collective esteem (how the public views the group you belong to), and importance to identity (importance of group membership to you).
- Stereotypes are beliefs that we hold about a person because of their membership in a specific cultural group. Although some stereotypes are accurate, many stereotypes that we may possess are based on faulty information or overgeneralizations of entire groups of people. Interpersonally, stereotypes become problematic because we often filter how we approach and communicate with people from different cultures because of the stereotypes we possess.

Exercises

- Think about a group that you currently belong to and consider the collective self-esteem you have for that group. How do you view this group in all four types of esteem: private collective, membership, public collective, and importance to identity?
- List the various stereotypes that you can think of for the following different groups: Gay Male, Transgendered Male, African American Male, Hispanic Female, White Male, and Pakistani Female. How do you think these stereotypes would impact your interpersonal interactions with people from these different groups?
- Think about ethnocentrism in your own life. When do you think ethnocentrism helps you have collective self-esteem, and when do you think it leads to prejudice?

6.3 Cultural Characteristics and Communication

LEARNING OUTCOMES

1. Differentiate between Edward T. Hall's low-context and high-context cultures.
2. Explain the importance of Geert Hofstede's research in cultural studies.
3. Summarize the importance of Stella Ting-Toomey's face and facework in interpersonal relationships.

In any major area of academic study, there are luminaries that one should understand. A luminary is an expert who sheds light on a subject and inspires and influences others' work in that area. In this section, we're going to examine three important luminaries that have helped shape our understanding of culture and intercultural communication: Edward T. Hall, Geert Hofstede, and Stella Ting-Toomey.

Edward T. Hall

One of the earliest researchers in the area of cultural differences and their importance to communication was a researcher by the name of Edward T. Hall. His book *Beyond Culture* is still considered one of the most influential books for the field of intercultural communication.^{17,18} According to Hall, all cultures incorporate both verbal and nonverbal elements into communication. In his 1959 book, *The Silent Language*, Hall states, "culture is communication and communication is culture."¹⁹ In the previous chapter, we talked about the importance of nonverbal communication. We also mentioned that nonverbal communication isn't exactly universal. Some gestures can mean wildly different things in different parts of the world. President George H. Bush once held up his hand in a "V" for Victory salute to an Australian audience only to find out later that this was the equivalent of the middle finger in the United States. President Nixon did the same thing existing an airplane in Brazil flashing his famous OK sign with his thumb and forefinger forming a circle, but this is the "middle finger" in that culture. Obviously, these two incidents have gone down in the annals of presidential history as cultural faux pas. Still, they illustrate the importance of knowing and understanding gestures in differing cultures because

we do not all interpret nonverbal behavior the same way.

One of Halls most essential contributions to the field of intercultural communication is the idea of low-context and high-context cultures. The terms “low-context culture” (LCC) and “high-context culture” (HCC) were created by Hall to describe how communication styles differ across cultures. In essence, “in LCC, meaning is expressed through explicit verbal messages, both written and oral. In HCC, on the other hand, intention or meaning can best be conveyed through implicit contexts, including gestures, social customs, silence, nuance, or tone of voice.”²⁰ Table 6.1 further explores the differences between low-context and high-context cultures. In Table 6.1, we broke down issues of context into three general categories: communication, cultural orientation, and business.

	Low-Context	High-Context
Communication		
Type of Communication	Explicit Communication	Implicit Communication
Communication Focus	Focus on Verbal Communication	Focus on Nonverbal Communication
Context of Message	Less Meaningful	Very Meaningful
Politeness	Not Important	Very Important
Approach to People	Direct and Confrontational	Indirect and Polite
Cultural Orientation		
Emotions	No Room for Emotions	Emotions Have Importance
Approach to Time	Monochromatic	Polychromatic
Time Orientation	Present-Future	Past
In/Out-Groups	Flexible and Transient Grouping Patterns	Strong Distinctions Between In and Out-Groups
Identity	Based on Individual	Based on Social System
Values	Independence and Freedom	Tradition and Social Rules/Norms
Business		
Work Style	Individualistic	Team-Oriented
Work Approach	Task-Oriented	Relationship-Oriented
Business Approach	Competitive	Cooperative
Learning	Knowledge is Transferable	Knowledge is Situational
Sales Orientation	Hard Sell	Soft Sell
View of Change	Change over Tradition	Tradition over Change

Table 6.1 Low-Context vs. High-Context Cultures

You may be wondering, by this point, how low-context and high-context cultures differ across different countries. Figure 6.2 illustrates some of the patterns of context that exist in today’s world.²¹

Geert Hofstede

Another very important researcher in the area of culture is a man by the name of Geert Hofstede. Starting in the 1970s, Geert became interested in how people from different cultures approach work. His interests ultimately culminated in his 1980 publication *Culture's Consequences: International Differences in Work-Related Values* where he explained some basic cultural differences.²² Over the years, Geert has fine-tuned his theory of culture, and the most recent update to his theory occurred in 2010.²³ In Geert's research examining thousands of workers from around the globe, he has noticed a series of six cultural differences: low vs. high power distance, individualism vs. collectivism, masculinity vs. femininity, low vs. high uncertainty avoidance, long-term vs. short-term orientation, and indulgence vs. restraint. Let's briefly look at each of these.

Low vs. High Power Distance

The first of Geert Hofstede's original dimensions of national cultures was power distance, or the degree to which those people and organizations with less power within a culture accept and expect that power is unequally distributed within their culture. To determine power differences within a culture, Hofstede originally was able to examine cultural value survey data that had been collected by IBM. Over the years, Hofstede and his fellow researchers have regularly collected additional data from around the world to make his conceptualization of six cultural differences one of the most widely studied concepts of culture. When it comes to power distances, these differences often manifest themselves in many ways within a singular culture: class, education, occupations, and health care. With class, many cultures have three clear segments low, middle, and upper. However, the concepts of what is low, middle, and upper can have very large differences. For example, the median income for the average U.S. household is \$51,100.²⁴ When discussing household incomes, we use the median (middlemost number) because it's the most accurate representation of income. According to a 2013 report from the U.S. Census department (using income data from 2012), here is how income inequality in the U.S. looks:

Households in the lowest quintile had incomes of \$20,599 or less in 2012. Households in the second quintile had incomes between \$20,600 and \$39,764, those in the third quintile had incomes between \$39,765 and \$64,582, and those in the fourth quintile had incomes between \$64,583 and \$104,096. Households in the highest quintile had incomes of \$104,097 or more. The top 5 percent had incomes of \$191,157 or more.²⁵

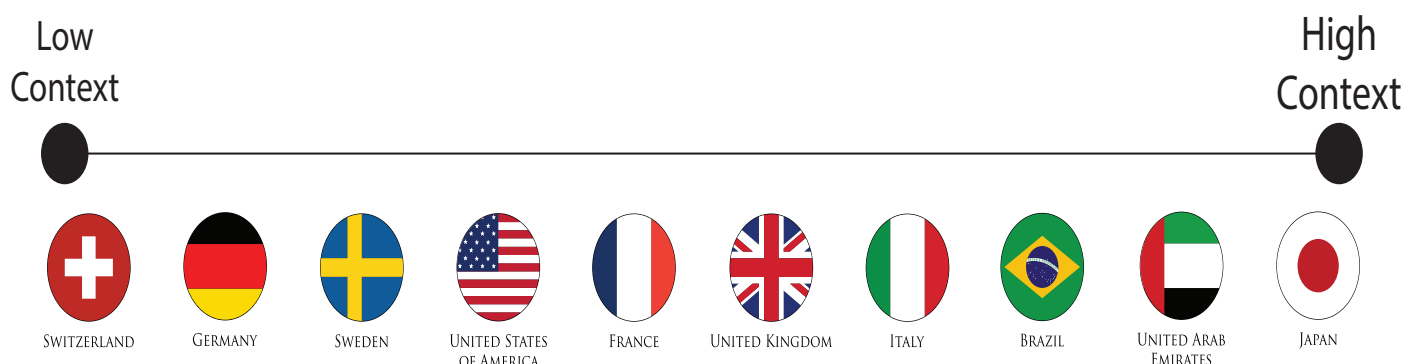

Figure 6.2 Low- and High-Context Nations

However, income is just one indicator of power distance within a culture. Others are who gets

educated and what type of education they receive, who gets health care and what type, and what types of occupations do those with power have versus those who do not have power. According to Hofstede's most recent data, the five countries with the highest power distances are: Malaysia, Slovakia, Guatemala, Panama, and the Philippines.²⁶ The five countries with the lowest power distances are Austria, Israel, Denmark, New Zealand, and Switzerland (German-speaking part). Notice that the U.S. does not make it into the top five or the bottom five. According to Hofstede's data, the U.S. is 16th from the bottom of power distance, so we are in the bottom third with regards to power distance. When it comes down to it, despite the issues we have in our country, the power disparity is not nearly as significant as it is in many other parts of our world.

Individualism vs. Collectivism

The United States is number one on individualism, according to Hofstede's data.²⁷ Americans are considered individualistic. In other words, we think about ourselves as individuals rather than the collective group. Most Asian countries are considered collectivistic cultures because these cultures tend to be group-focused. Collectivistic cultures tend to think about actions that might affect the entire group rather than specific members of the group.

In an individualistic culture, there is a belief that you can do what you want and follow your passions. In an individualistic culture, if someone asked what you do for a living, they would answer by saying their profession or occupation. However, in collectivistic cultures, a person would answer in terms of the group, organization, and/or corporation that they serve. Moreover, in a collectivistic culture, there is a belief that you should do what benefits the group. In other words, collectivistic cultures focus on how the group can grow and be productive.

Masculinity vs. Femininity

The notion of masculinity and femininity are often misconstrued to be tied to their biological sex counterparts, female and male. For understanding culture, Hofstede acknowledges that this distinction ultimately has a lot to do with work goals.²⁸ On the masculine end of the spectrum, individuals tend to be focused on items like earnings, recognition, advancement, and challenge. Hofstede also refers to these tendencies as being more assertive. Femininity, on the other hand, involves characteristics like having a good working relationship with one's manager and coworkers, cooperating with people at work, and security (both job and familial). Hofstede refers to this as being more relationally oriented. Admittedly, in Hofstede's research, there does tend to be a difference between females and males on these characteristics (females tend to be more relationally oriented and males more assertive), which is why Hofstede went with the terms masculinity and femininity in the first place. Ultimately, we can define these types of cultures in the following way:

A society is called masculine when emotional gender roles are clearly distinct: men are supposed to be assertive, tough, and focused on material success, whereas women are supposed to be more modest, tender, and concerned with quality of life.

A society is called feminine when emotional gender roles overlap: both men and women are supposed to be modest, tender, and concerned with quality of life [emphasis in original].²⁹

The top five most masculine countries are Slovakia, Japan, Hungary, Austria, and Venezuela (the

U.S. is number 19 out of 76); whereas, feminine countries are represented by Sweden, Norway, Latvia, Netherlands, and Denmark. As you can imagine, depending on the type of culture you live in, you will have wildly different social interactions with other people. There's also a massive difference in the approach to marriage. In masculine cultures, women are the caretakers of the home, while men are to be healthy and wealthy. As such, women are placed in a subservient position to their husbands are often identified socially by their husbands. For example, an invitation to a party would be addressed to "Mr. and Mrs. John Smith." In feminine cultures, men and women are upheld to the same standards, and their relationships should be based on mutual friendship.

Low vs. High Uncertainty Avoidance

The next category identified by Hofstede involves the concept of uncertainty avoidance.³⁰ Life is full of uncertainty. We cannot escape it; however, some people are more prone to becoming fearful in situations that are ambiguous or unknown. Uncertainty avoidance then involves the extent to which cultures as a whole are fearful of ambiguous and unknown situations. People in cultures with high uncertainty avoidance can view this ambiguity and lack of knowledge as threatening, which is one reason why people in these cultures tend to have higher levels of anxiety and neuroticism as a whole. In fact, within the latest edition of the book examining these characteristics, Hofstede and his colleagues title the chapter on uncertainty avoidance as "What is Different is Dangerous," calling out the threat factor people in high uncertainty avoidance cultures feel.³¹ Cultures at the high end of uncertainty avoidance include Greece, Portugal, Guatemala, Uruguay, and Belgium Flemish; whereas, cultures at the low end of uncertainty avoidance include Singapore, Jamaica, Denmark, Sweden, and Hong Kong. The United States ranks 64th out of 76 countries analyzed (Singapore was number 76). From an interpersonal perspective, people from high uncertainty avoidant cultures are going to have a lot more anxiety associated with interactions involving people from other cultures. Furthermore, there tend to be higher levels of prejudice and higher levels of ideological, political, and religious fundamentalism, which does not allow for any kind of debate.

Long-Term vs. Short-Term Orientation

In addition to the previous characteristics, Hofstede noticed a fifth characteristic of cultures that he deemed long-term and short-term orientation. Long-term orientation focuses on the future and not the present or the past. As such, there is a focus on both persistence and thrift. The emphasis on endurance is vital because being persistent today will help you in the future. The goal is to work hard now, so you can have the payoff later. The same is true of thrift. We want to conserve our resources and under-spend to build that financial cushion for the future. Short-term oriented cultures, on the other hand, tend to focus on both the past and the present. In these cultures, there tends to be high respect for the past and the various traditions that have made that culture great. Additionally, there is a strong emphasis on "saving face," which we will discuss more in the next section, fulfilling one's obligations today, and enjoying one's leisure time. At the long-term end of the spectrum are countries like China, Hong Kong, Taiwan, and Japan; whereas, countries like Pakistan, Czech Republic, Nigeria, Spain, and the Philippines are examples of short-term. The United States ranked 31 out of 39, with Pakistan being number 39. Interpersonally, long-term oriented countries were more satisfied with their contributions to "Being attentive to daily human relations, deepening human bonds in family, neighborhood and friends or acquaintances" when compared to their short-term counterparts.³²

Indulgence vs. Restraint

The final characteristic of cultures is a new one first reported on in the 2010 edition of *Cultures and Organizations*.³³ The sixth cultural characteristic is called indulgence vs. restraint, which examines issues of happiness and wellbeing. According to Hofstede and his coauthors, “Indulgence stands for a tendency to allow relatively free gratification of basic and natural human desires related to enjoying life and having fun. Its opposite pole, restraint, reflects a conviction that such gratification needs to be curbed and regulated by strict social norms.”³⁴ The top five on the Indulgence end are Venezuela, Mexico, Puerto Rico, El Salvador, and Nigeria, whereas those on the restraint end are Pakistan, Egypt, Latvia, Ukraine, and Albania. The U.S. is towards the indulgence end of the spectrum and ranks at #15 along with Canada and the Netherlands. Some interesting findings associated with indulgence include experiencing higher levels of positive emotions and remembering those emotions for more extended periods. Furthermore, individuals from more indulgent cultures tend to be more optimistic, while their restrained counterparts tend to be more cynical. People in more indulgent countries are going to be happier than their restrained counterparts, and people within indulgent cultures show lower rates of cardiovascular problems commonly associated with stress. Finally, individuals from indulgent cultures tend to be more extraverted and outgoing as a whole, whereas individuals from restrained cultures tend to be more neurotic. From years of research examining both extraversion and neuroticism, we know that extraverted individuals have more successful interpersonal relationships than those who are highly neurotic. Ultimately, research examining these differences have shown that people from indulgent countries are more open to other cultures, more satisfied with their lives, and are more likely to communicate with friends and family members via the Internet while interacting with more people from other cultures via the Internet as well.

Research Spotlight



In 2017, Daniel H. Mansson and Aldís G. Sigurðardóttir set out to examine the concept of trait affection in relation to Hofstede’s theoretical framework. “Affectionate communication is conceptualized as a person’s use of intentional and overt communicative behaviors to convey feelings of closeness, care, and fondness in the form of verbal statements, nonverbal behaviors, and social support.”³⁵

For this study, the researchers studied 606 participants in four different countries: Denmark, Iceland, Poland, and the United States.

When it came to trait affection given, the United States participants reported giving more affection than any of the three other countries. The other countries did not differ from each other with regard to trait affection given.

When it came to trait affection received, all four groups differed from one another. The order of affection received was (in order of the most trait affection received) United States, Denmark, Poland, and Iceland.

Finally, the researchers examined affection given and received with regards to Hofstede’s work. “The results also indicated that trait affection given was significantly associated with the individualism-collectivism, masculinity-femininity, and uncertainty avoidance dimensions of cultures. Similarly, trait affection received was significantly associated with the individualism-collectivism and uncertainty avoidance dimensions of cultures.”³⁶

Mansson, D. H., & Sigurðardóttir, A. G. (2017). Trait affection given and received: A test of Hofstede’s theoretical framework. *Journal of Intercultural Communication Research*, 46(2), 161-172. <https://doi.org/10.10>

Stella Ting-Toomey

In 1988, intercultural communication research Stella Ting-Toomey developed face-negotiation theory to help explain the importance of face within interpersonal interactions.³⁷ The basic idea behind face-negotiation theory is that face-saving, conflict, and culture are all intertwined. In the most recent version of her theory, Stella Ting-Toomey outlines seven basic factors of face-negotiation theory:

1. People in all cultures try to maintain and negotiate face in all communication situations.
2. The concept of face is especially problematic in emotionally vulnerable situations (such as embarrassment, request, or conflict situations) when the situation identities of the communicators are called into question.
3. The cultural variability dimensions of individualism-collectivism and small/large power distance shape the orientations, movements, contents, and styles of facework.
4. Individualism-collectivism shapes members' preferences for self-oriented facework versus other-oriented facework.
5. Small/large power distance shapes members' preferences for horizontal-based facework versus vertical-based facework.
6. The cultural variability dimensions, in conjunction with individual, relational, and situational factors influence the use of particular facework behaviors in particular cultural scenes.
7. Intercultural facework competence refers to the optimal integration of knowledge, mindfulness, and communication skills in managing vulnerable identity-based conflict situations appropriately, effectively, and adaptively.³⁸

First and foremost, communication and face are highly intertwined concepts, so when coming to an intercultural encounter, it is important to remember the interrelationship between the two. As far as Ting-Toomey's theory goes, she takes this idea one step further to understanding how face and communication ultimately enable successful intercultural conflict management. Face-negotiation theory ultimately concerned with three different types of face: self-face (concern for our face), other-face (concern for another person's face), and mutual-face (concern for both interactants and the relationship).³⁹ As you can see from Ting-Toomey's last assumption in her theory above, individuals who are competent in facework can recognize when facework is necessary and then handle those situations appropriately, effectively, and adaptively. As such, facework should be viewed as a necessary component for understanding any form of interpersonal interaction but is especially important when examining interpersonal interactions that occur between people from differing cultural backgrounds.

Key Takeaways

- Low-context cultures are cultures where the emphasis is placed on the words that come out of an individual's mouth. High-context cultures, on the other hand, are cultures where understanding a message is dependent on the cultural context and a communicator's nonverbal behavior.
- Geert Hofstede's research created a taxonomy for understanding and differentiating cultures. Geert's taxonomy was originally based on data collected by IBM, and he found that cultures could be differentiated by power distance, individualism/

What is Face?

The concept of **face** is one that is not the easiest to define nor completely understand. Originally, the concept of face is not a Western even though the idea of “saving face” is pretty common in every day talk today. According to Hsien Chin Hu, the concept of face stems from two distinct Chinese words, *lien* and *mien-tzu*.⁴⁵ *Lien* “represents the confidence of society in the integrity of ego’s moral character, the loss of which makes it impossible for him to function properly within the community. *Lien* is both a social sanction for enforcing moral standards and an internalized sanction.”⁴⁶ On the other hand, *mien-tzu* “stands for the kind of prestige that is emphasized in this country [America]: a reputation achieved through getting on in life, through success and ostentation.”⁴⁷ However, David Yau-fai Ho argues that face is more complicated than just *lien* and *mien-tzu*, so he provided the following definition:

Face is the respectability and/or deference which a person can claim for himself from others, by virtue of the relative position he occupies in his social network and the degree to which he is judged to have functioned adequately in that position as well as acceptably in his general conduct; the face extended to a person by others is a function of the degree of congruence between judgments of his total condition in life, including his actions as well as those of people closely associated with him, and the social expectations that others have placed upon him. In terms of two interacting parties, face is the reciprocated compliance, respect, and/or deference that each party expects from, and extends to, the other party.⁴⁸

More simplistically, face is essentially “a person’s reputation and feelings of prestige within multiple spheres, including the workplace, the family, personal friends, and society at large.”⁴⁹ For our purposes, we can generally break face down into general categories: face gaining and face losing. Face gaining refers to the strategies a person might use to build their reputation and feelings of prestige (e.g., talking about accomplishments, active social media presence), whereas face losing refers to those behaviors someone engages in that can harm their reputation or feelings of prestige (e.g., getting caught in a lie, failing).

collectivism, masculinity vs. femininity, uncertainty avoidance, long-term vs. short-term orientation, and indulgence vs. restraint.

- Face is the standing or position a person has in the eyes of others. During an interpersonal interaction, individuals strive to create a positive version of their face for the other person.
-

Exercises

- Compare and contrast two countries and their levels of context. Why do you think context is such an important cultural characteristic?
- Think about a co-cultural group that you belong to. Think through Geert Hofstede’s six categories used to evaluate differing cultures and apply Hofstede’s

- ideas to your co-culture. Does your co-culture differ from the dominant culture?
- Imagine you're having an interaction with an individual from India. During the middle of the conversation, you have a feeling that your interactional partner is losing face. What could you do at that point to help rebuild that person's face? Why would you want to do this at all?

6.4 Improving Intercultural Communication Skills

LEARNING

OUTCOMES

1. Explain the importance of cultural intelligence.
2. Learn about metacognitive CQ.
3. Identify several different ways to create better intercultural interactions.

Become Culturally Intelligent

One of the latest buzz-words in the business world is “cultural intelligence,” which was initially introduced to the scholarly community in 2003 by P. Christopher Earley and Soon Ang.⁴⁰ In the past decade, a wealth of research has been conducted examining the importance of cultural intelligence during interpersonal interactions with people from other cultures. Cultural intelligence (CQ) is defined as an “individual’s capability to function effectively in situations characterized by cultural diversity.”⁴¹

Four Factors of Cultural Intelligence

In their original study on the topic, Earley and Ang argued that cultural intelligence is based on four distinct factors: cognitive, motivational, metacognitive, and behavioral dimensions. Before continuing, take a minute and complete the Cultural Intelligence Questionnaire in Table 6.2

Cognitive CQ

First, cognitive CQ involves knowing about different cultures (intercultural knowledge). Many types of knowledge about a culture can be relevant during an intercultural interaction: rules and norms, economic and legal systems, cultural values and beliefs, the importance of art within a society, etc.... All of these different areas of knowledge involve facts that can help you understand people from different cultures. For example, in most of the United States, when you are talking to someone, eye contact is very important. You may have even been told by someone to “look at me when I’m talking to you” if you’ve ever gotten in trouble. However, this isn’t consistent across different cultures at all. Hispanic, Asian, Middle Eastern, and Native American cultures often view direct contact when talking to someone superior as a sign of disrespect. Knowing how eye contact functions across cultures can help you know more about how to interact with people from various cultures. Probably one of the best books you can read to know more about how to communicate in another culture is Terri Morrison and Wayne A. Conaway’s book *Kiss, Bow, or Shake Hands: The Bestselling Guide to Doing Business in More than 60*

Motivational CQ

Second, we have motivational CQ, or the degree to which an individual desires to engage in intercultural interactions and can easily adapt to different cultural environments. Motivation is the key to effective intercultural interactions. You can have all the knowledge in the world, but if you are not motivated to have successful intercultural interactions, you will not have them.

Metacognitive CQ

Third, metacognitive CQ involves being consciously aware of your intercultural interactions in a manner that helps you have more effective interpersonal experiences with people from differing cultures (intercultural understanding). All of the knowledge about cultural differences in the world will not be beneficial if you cannot use that information to understand and adapt your behavior during an interpersonal interaction with someone from a differing culture. As such, we must always be learning about cultures but also be ready to adjust our knowledge about people and their cultures through our interactions with them.

Behavioral CQ

Lastly, behavioral CQ is the next step following metacognitive CQ, which is behaving in a manner that is consistent with what you know about other cultures.⁴³ We should never expect others to adjust to us culturally. Instead, culturally intelligent people realize that it's best to adapt our behaviors (verbally and nonverbally) to bridge the gap between people culturally. When we go out of our way to be culturally intelligent, we will encourage others to do so as well.

As you can see, becoming a truly culturally intelligent person involves a lot of work. As such, it's important to spend time and build your cultural intelligence if you are going to be an effective communicator in today's world.

Engaging Culturally Mindful Interactions

Admittedly, being culturally competent takes a lot of work and a lot of practice. Even if you're not completely culturally competent, you can engage with people from other cultures in a mindful way. As discussed in Chapter 1, Shauna Shapiro and Linda Carlson introduced us to the three-component model of mindfulness: attention, intention, and attitude.⁴⁴

First, when it comes to engaging with people from other cultures, we need to be fully in the moment and not think about previous interactions with people from a culture or possible future interactions with people from a culture. Instead, it's essential to focus on the person you are interacting with. You also need to be aware of your stereotypes and prejudices that you may have of people from a different culture. Don't try to find evidence to support or negate these stereotypes or prejudices. If you focus on evidence-finding, you're just trying to satisfy your thoughts and feelings and not mindfully engaging with this other person. Also, if you find that your mind is shifting, recognize the shift and allow yourself to re-center on your interaction with the other person.

Second, go into an intercultural interaction knowing your intention. If your goal is to learn more about that person's culture, that's a great intention. However, that may not be the only intention we have

Instructions: Read the following questions and select the answer that corresponds with your perception. Do not be concerned if some of the items appear similar. Please use the scale below to rate the degree to which each statement applies to you.

Strongly Disagree 1	Disagree 2	Neutral 3	Agree 4	Strongly Agree 5
-------------------------------	----------------------	---------------------	-------------------	----------------------------

1. When I'm interacting with someone from a differing culture, I know when I use my knowledge of that person's culture during my interactions.
2. When I interact with someone from a culture I know nothing about, I have no problem adjusting my perspective of their culture while we talk.
3. During intercultural interactions, I am well aware of the cultural knowledge I utilize.
4. I always check my knowledge of someone from another culture to ensure that my understanding of their culture is accurate.
5. During my intercultural interactions, I try to be mindful of how my perceptions of someone's culture are either consistent with or differ from reality.
6. I pride myself on knowing a lot about other people's cultures.
7. I understand the social, economic, and political systems of other cultures.
8. I know about other cultures' religious beliefs and values.
9. I understand how daily life is enacted in other cultures.
10. I know the importance of paintings, literature, and other forms of art in other cultures.
11. I enjoy reaching out and engaging in an intercultural encounter.
12. I would have no problem socializing with people from a new culture.
13. Although intercultural encounters often involve stress, I don't mind the stress because meeting people from new cultures makes it worth it.
14. I would have no problems accustoming myself to the routines of another culture.
15. I enjoy being with people from other cultures and getting to know them.
16. I know how to interact verbally with people from different cultures.
17. I know how to interact nonverbally with people from different cultures.
18. I can vary my rate of speech if an intercultural encounter requires it.
19. I can easily alter my behaviors to suit the needs of an intercultural encounter.
20. I can alter my facial expressions if an intercultural encounter requires it.

Scoring To compute your scores follow the instructions below:

Add items 1-5 (Intercultural Understanding) = _____

Add items 6-10 (Intercultural Knowledge) = _____

Add items 7-15 (Intercultural Motivation) = _____

Add items 16-20 (Intercultural Behavior) = _____

Interpretation

Scores for each of the four factors (intercultural understanding, intercultural knowledge, intercultural motivation, and intercultural behavior) can be added together to get a composite score. Each of the four factors exists on a continuum from 5 (not culturally intelligent) to 25 (highly culturally intelligent). An average person would score between 12-18.

Based On:

Van Dyne, L., Ang, S., & Koh, C. (2008). Development and validation of the CQS: The Cultural Intelligence Scale. In S. Ang & L. Van Dyne (Eds.), *Handbook of cultural intelligence: Theory, measurement, and application* (pp. 16-38). Armonk, NY: M. E. Sharpe.

Table 6.2 Cultural Intelligence Questionnaire

when interacting with someone from another culture. For example, you may be interacting with someone from another culture because you're trying to sell them a product you represent. If your main intention is sales, then be aware of your intention and don't try to deceive yourself into thinking it's something more altruistic.

Lastly, go into all intercultural interactions with the right attitude. Remember, the goal of being mindful is to be open, kind, and curious. Although we often discuss mindful in terms of how we can be open, kind, and curious with ourselves, it's also important to extend that same framework when we are interacting with people from other cultures. So much of mindful relationships is embodying the right attitude during our interactions with others. If you need a refresher on building the right attitude during your interactions, go back and look at Daniel Siegel's COAL Jon Kabat-Zinn's Seven Attitudes for Mindfulness discussed in Chapter 1.

Overall, the goal of mindful intercultural interactions is to be present in the moment in a nonjudgmental way. When you face judgments, recognize them, and ask yourself where they have come from. Interrogate those judgments. At the same time, don't judge yourself for having these ideas. If we have stereotypes about another a specific culture, it's important to recognize those stereotypes, call them out, understand where they came from in the first place, and examine them for factualness.

For example, imagine you're talking to someone from the Republic of Kiribati. Chances are, you've probably never heard of the Republic of Kiribati, but it's a real country in Oceania. But let's say all you know about the people from the Republic of Kiribati is that they like European-style football. During your interaction, you say, "So, what's your favorite football team?" In this moment, you've taken the one stereotype you had and used it to help engage in an interaction. However, if the person comes back and says, "I really don't care. Sports just aren't my thing." How do you respond? First, recognize that you attempted to use a stereotype that you had and call it out for what it was. That doesn't make you a bad person, but we must learn from these encounters and broaden our world views. Second, call out the stereotype in your mind. Before that moment, you may not have even realized that you had a stereotype of people from the Republic of Kiribati. Labeling our stereotypes of other people is important because it helps us recognize them faster, the more we engage in this type of mindful behavior. Third,

figure out where that stereotype came from. Maybe you had been in New Zealand and saw a match on the television and saw the Kiribati national football team. In that one moment, you learned a tiny bit about an entire country and pocketed it away for future use. Sometimes it's easy to figure out where our stereotypes evolved from, but sometimes these stereotypes are so ingrained in us through our own culture that it's hard to really figure out their origin. Lastly, it's time to realize that your stereotype may not be that factual. At the same time, you may have found the one resident of the Republic of Kiribati who doesn't like football. We can often make these determinations by talking to the other person.

At the same time, it's important also to be mindfully open to the other person's stereotypes of people within your own culture. For example, someone from the Republic of Kiribati may have a stereotype that Americans know nothing about football (other than American football). If you're a fan of what we in the U.S. call soccer, then you correct that stereotype or at least provide that person a more nuanced understanding of your own culture. Sure, American football still is the king of sports in the U.S., but media trends for watching football (soccer) are growing, and more and more Americans are becoming fans.

Key Takeaways

- Cultural intelligence involves the degree to which an individual can communicate competently in varying cultural situations. Cultural intelligence consists of four distinct parts: knowledge, motivation, understanding, and behavior.
- Having strong intercultural relationships can be very rewarding. When thinking about your own intercultural relationships, some ways to have more rewarding intercultural relationships can include: understanding your own culture better, being interested in other people and their cultures, respecting other people's cultures, becoming culturally intelligent, tolerating ambiguity during interactions, being aware of and overcoming your own ethnocentrism, and being a good example of your own culture.

Exercises

- The Cultural Intelligence Center has created a widely used 20-item measure for cultural intelligence. Please take a second and complete their measure: <http://www.culturalq.com/docs/The%20CQS.pdf> What were your CQ strengths and CQ weaknesses? Where would you most want to improve your CQ?
- Visit the National Center for Cultural Competence at <http://nccc.georgetown.edu/about.html>. Read some of the material on their website. Look for their ideas and compare to what you've learned in this section.
- James L. Mason created a cultural competence tool for service agencies (<http://files.eric.ed.gov/fulltext/ED399684.pdf>). Take a look at their tool, which is freely available online. What do you think of their tools for evaluating cultural competence? Do you think cultural competence and cultural intelligence are similar, different, or identical? Why?

Chapter Wrap-Up

In this chapter, we started by discussing what the word “culture” means while also considering the concepts of co-culture and microcultures. We then looked at the critical functions that culture performs in our daily lives. Next, we discussed the intersection of culture and communication. Lastly, we ended this chapter discussing how you can improve your intercultural communication skills.

End of Chapter

KEY TERMS

- Behavioral CQ
- Belief
- Co-Culture
- Cognitive CQ
- Collective Self-Esteem
- Collectivism
- Cultural Intelligence
- Culture
- Culture as Normative
- Dominant Culture
- Ethnocentrism
- Face
- Feminine
- High-Context Cultures
- Importance to Identity
- Indigenous Peoples
- Individualism
- Indulgence
- Long-Term Orientation
- Low-Context Cultures
- Masculine
- Membership Esteem
- Metacognitive CQ
- Microculture
- Motivational CQ
- Norms
- Ostracized
- Power Distance
- Private Collective Esteem
- Public Collective Self-Esteem
- Restraint
- Rules
- Short-Term Orientation
- Stereotype
- Uncertainty Avoidance
- Values

REAL WORLD CASE STUDY

Roy and Jalissa originally met in graduate school. On the first day that Jalissa walked into grad school, she was glad to see someone else near her age, which was older than the average student in the class. Even though Roy was White and Jalissa was African American, the two immediately felt drawn to each other. Before they knew it, Jalissa and Roy were inseparable. Jalissa’s husband started to get jealous of Roy until he met Roy and realized that Roy was gay.

Over the years, the two graduated and went to different jobs that were close to each other. Roy and Jalissa still would get together regularly and go shopping, go to the movies, have dinner, etc. The two of them considered themselves as highly culturally intelligent people. Jalissa was a Dean of Diversity at a liberal arts college, and Roy taught cultural studies at a large research university. The two often had pet names for each other that people outside of their relationship could view as racist or homophobic, but they knew the spirit behind their pet names was meant in jest and not ignorance, ethnocentrism, or fear.

One day Roy and Jalissa were hanging how in a store when Roy found an African Mask. Roy grabbed the mask, walked up behind Jalissa, and shouted, “Abugga bugga!” Jalissa turned around and laughingly slapped Roy on the arm responding, “You White racist cracker!” Jalissa looked at an older White woman standing in the row completely startled, and she just busted out laughing and Roy joined right in.

1. In this case, was Roy culturally intelligent? Why?
2. In this case, was Jalissa culturally intelligent? Why?
3. Was this interpersonal interaction appropriate? Why?

END OF CHAPTER QUIZ

1. Milagros belongs to a very distinct South American tribe. Bravery is very important in her tribe. From an early age, all boys and girls are taught that bravery is akin to being a member of the tribe. Furthermore, people who are not brave are often banished from the tribe. For this tribe, what does bravery represent?
 - a. a rule
 - b. a norm
 - c. a value
 - d. a belief
 - e. a worth
2. African Americans; Bisexuals, Gays, and Lesbians; Irish Americans, Southerners are all examples of what?
 - a. dominant cultures
 - b. co-cultures
 - c. subcultures
 - d. microcultures
 - e. collaborative cultures
3. As a transgendered individual, Melanie realizes that many people in her dominant culture do not understand, agree with, nor support transgendered individuals and causes. Which facet of collective self-esteem does this represent?
 - a. private collective esteem
 - b. membership esteem
 - c. public collective esteem
 - d. importance to identity
 - e. other esteem
4. The degree to which an individual views the world from their own culture’s perspective while evaluating other cultures according to their culture’s preconceptions often accompanied by feelings of dislike, mistrust, or hate for cultures deemed inferior?
 - a. ethnocentrism
 - b. stereotypes
 - c. prejudice
 - d. discrimination
 - e. cultural annoyance

5. Juan's culture is marked by expensive houses, fast cars, rich food, and all the luxuries one could desire. Which of Hofstede's cultural differences does Juan's culture represent?
- a. individualism
 - b. high power distance
 - c. masculinity
 - d. short-term orientation
 - e. indulgence

References

- 1 Kroeber, A. L., & Kluckhohn, C. (1952). *Culture: A critical review of concepts and definitions*. Harvard University Press.
- 2 Ibid.; pgs. 6-7.
- 3 Baldwin, J. R., Faulkner, S. L., Hecht, M. L., & Lindsley, S. L. (2006). *Redefining culture: Perspectives across the disciplines*. Lawrence Erlbaum.
- 4 Wrench, J. S. (2001). *Intercultural communication: Power in context*. Tapestry Press; pg. 12.
- 5 Leeming, D. A., & Lemming, M. A. (2009). *A dictionary of creation myths*. Oxford University Press.
- 6 Spradley, J. P., & McCurdy, D. W. (2008). *Conformity and conflict: Readings in cultural anthropology*. Pearson; pg. 3.
- 7 Kevin. (n. d.). Disney traditions [Web log post]. <https://disneyprogramsblog.com/disney-traditions/>
- 8 Tajfel, H. (1981). *Social identity and intergroup relations*. Cambridge University Press; pg. 255.
- 9 Luhtanen, R., & Crocker, J. (1992). A collective self-esteem scale: Self-evaluation of one's social identity. *Personality and Social Psychology Bulletin*, 18(3), 302-318. <https://doi.org/10.1177/0146167292183006>
- 10 Bailis, D. S., & Chipperfield, J. G. (2006). Emotional and self-evaluative effects of social comparison information in later life: How are they moderated by collective self-esteem? *Psychology and Aging*, 21(2), 291-302. <https://doi.org/10.1037/0882-7974.21.2.291>
- 11 Downie, M., Mageau, G. A., Koestner, R., & Liodden, T. (2006). On the risk of being a cultural chameleon: Variations in collective self-esteem across social interactions. *Cultural Diversity and Ethnic Minority Psychology*, 12(3), 527-540. <https://doi.org/10.1037/1099-9809.12.3.527>
- 12 Ibid.; pg. 537.
- 13 Ashmore, R. D., & Del Boca, F. K. (1981). Conceptual approaches to stereotypes and stereotyping. In D. L. Hamilton (Ed.), *Cognitive processes in stereotyping and intergroup behavior* (pp. 1-35). Erlbaum; pg. 21.
- 14 Lee, Y. T., Jussim, L. J., & McCauley, C. R. (Eds.). (1995). *Stereotype accuracy: Toward appreciating group differences*. American Psychological Association.
- 15 Saenz, R., & Evans, L. (2009, June). *The changing demography of U.S. flight attendants*. Population Reference Bureau. [website] <http://www.prb.org/Publications/Articles/2009/usflightattendants.aspx>
- 16 Novinger, T. (2001). *Intercultural communication: A practical guide*. University of Texas Press.
- 17 Hall, E. T. (1977). *Beyond culture*. Anchor Press.
- 18 Rogers, E. M., Hart, W. B., & Mike, Y. (2002). Edward T. Hall and the history of intercultural communication: The United States and Japan. *Keio Communication Review* (24): 3-26. <http://www.mediacom.keio.ac.jp/publication/pdf2002/review24/2.pdf>
- 19 Hall, E. T. (1981). *The Silent Language*. Anchor Books. (Reprint of *The Silent Language* by E. T. Hall, 1959, Doubleday; pg. 186.
- 20 Nam, K. A. (2015). High-context and low-context communication. In J. M. Bennett (Ed.), *The SAGE encyclopedia of intercultural competence* (pp. 377-381). Sage; pg. 378.
- 21 Rösch M., Segler K. G. (1987). Communication with Japanese. *Management International Review*, 27(4), 56-67.
- 22 Hofstede, G. (1980). *Culture's consequences: International differences in work-related values*. Sage.
- 23 Hofstede, G., Hofstede, G. J., & Minkov, M. (2010). *Cultures and organizations: Software of the mind* (3rd ed.). McGraw-Hill.
- 24 DeNavas-Walt, C., Proctor, B. D., & Smith, J. C. (2013). *U.S. census bureau current population reports, P60-245: Income, poverty, and health insurance coverage in the United States: 2012*. U.S. Government Printing Office.
- 25 Ibid. pg. 9.
- 26 Hofstede, G., Hofstede, G. J., & Minkov, M. (2010). *Cultures and organizations: Software of the mind* (3rd ed.). McGraw-Hill.

- 27 Ibid.
- 28 Ibid.
- 29 Hofstede, G., & Hofstede, G. J. (2005). *Cultures and organizations: Software of the mind* (2nd ed.). McGraw-Hill; pg. 120.
- 30 Ibid.
- 31 Ibid.
- 32 Hofstede, G., & Hofstede, G. J. (2005). *Cultures and organizations: Software of the mind* (2nd ed.). McGraw-Hill; pg. 230.
- 33 Hofstede, G., Hofstede, G. J., & Minkov, M. (2010). *Cultures and organizations: Software of the mind* (3rd ed.). McGraw-Hill.
- 34 Ibid Kindle Locations 4809-4811.
- 35 Mansson, D. H., & Sigurðardóttir, A. G. (2017). Trait affection given and received: A test of Hofstede's theoretical framework. *Journal of Intercultural Communication Research*, 46(2), 161-172. <https://doi.org/10.1080/17475759.2017.1292944>; pgs. 163-164.
- 36 Mansson, D. H., & Sigurðardóttir, A. G. (2017). Trait affection given and received: A test of Hofstede's theoretical framework. *Journal of Intercultural Communication Research*, 46(2), 161-172. <https://doi.org/10.1080/17475759.2017.1292944>; pg. 168.
- 37 Ting-Toomey, S. (1988). Intercultural conflicts: A face-negotiation theory. In Y. Y. Kim & W. B. Gudykunst (Eds.), *Theories in intercultural communication* (pp. 213-235). Sage.
- 38 Ting-Toomey, S. (2005). The matrix of face: An updated face-negotiation theory. In W.B. Gudykunst (Ed.), *Theorizing about intercultural communication* (pp. 71-92). Sage.
- 39 Ting-Toomey, S., & Kurogi, A. (1998). Facework competence in intercultural conflict: An updated face-negotiation theory. *International Journal of Intercultural Relations*, 22(2), 187-225. [https://doi.org/10.1016/S0147-1767\(98\)00004-2](https://doi.org/10.1016/S0147-1767(98)00004-2)
- 40 Earley, P. C., & Ang, S. (2003). *Cultural intelligence: Individual interactions across cultures*. Stanford University Press.
- 41 Ang, S., Van Dyne, L. (Eds.). (2008). Preface and Acknowledgements. In *Handbook of cultural intelligence: Theory, measurement, and applications* (pp. xv-xviii). M. E. Sharpe; pg. xv.
- 42 Morrison, T., & Conaway, W. A. (2006). *Kiss, bow, or shake hands: The bestselling guide to doing business in more than 60 countries*. Adams Media.
- 43 Ang, S., Van Dyne, L. (Eds.). (2008). Conceptualization of cultural intelligence definition, distinctiveness, and nomological network. In *Handbook of cultural intelligence: Theory, measurement, and applications* (pp. 3-55). M. E. Sharpe.
- 44 Shapiro, S. L., & Carlson, L. E. (2017). *The art and science of mindfulness: Integrating mindfulness into psychology and the helping professions* (2nd ed.). American Psychological Association.
- 45 Hu, H. (1944). The Chinese concepts of "face." *American Anthropologist*, 46(1), 45-64. www.jstor.org/stable/662926
- 46 Ibid.; pg. 45.
- 47 Ibid.; pg. 45.
- 48 Ho, D. Y.-f. (1976). On the concept of face. *American Journal of Sociology*, 81(4), 867-884. www.jstor.org/stable/2777600
- 49 Upton-McLaughlin, S. (2013). Gaining and losing face in China. The China Culture Corner. Retrieved from <https://chinaculturecorner.com/2013/10/10/face-in-chinese-business/>; para. 2.

END OF CHAPTER QUIZ

ANSWER KEY

1) C 2) B 3) C 4) A 5) B

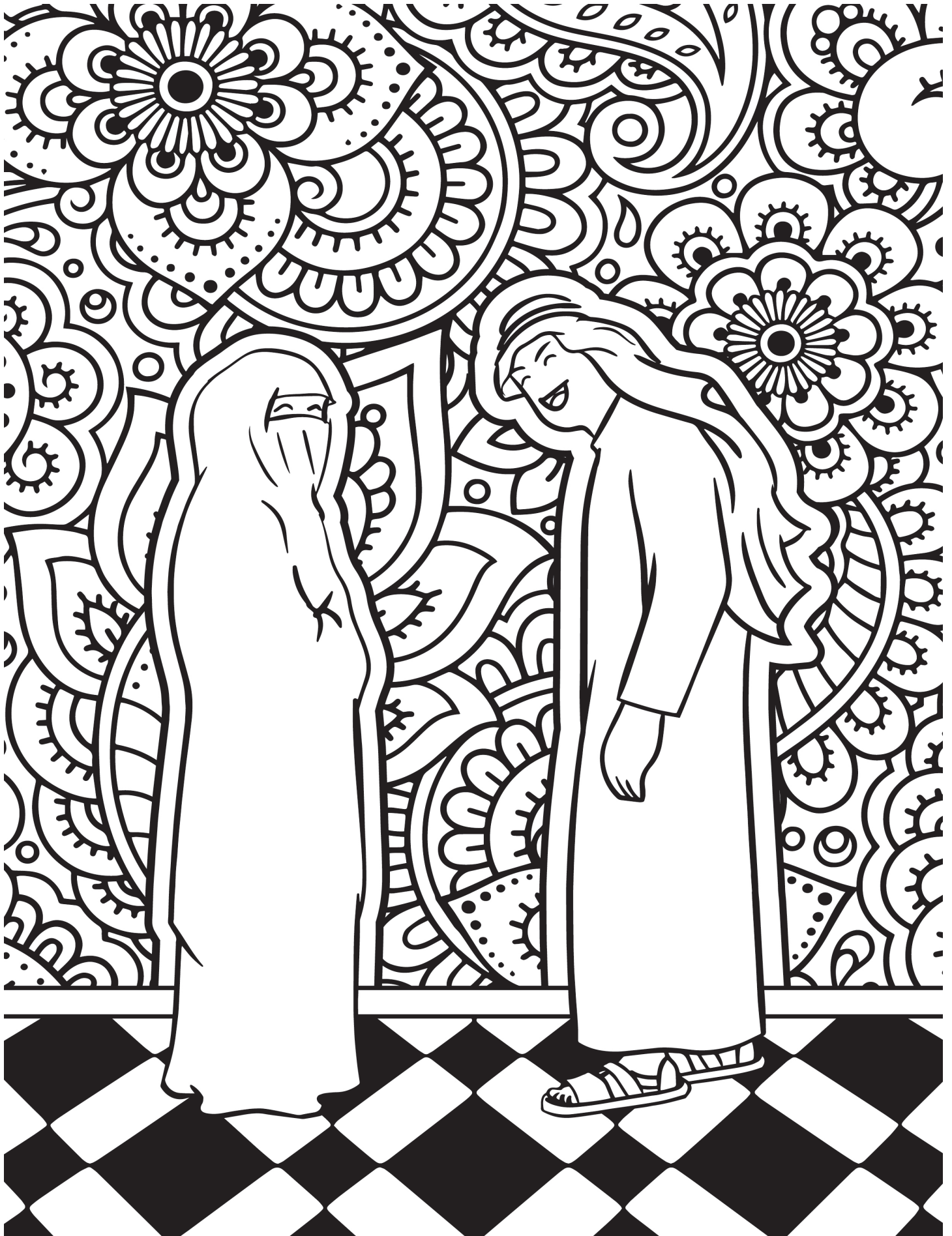



Image by jamesoladujoye from Pixabay

Chapter 7

Talking and Listening

We are constantly interacting with people. We interact with our family and friends. We interact with our teachers and peers at school. We interact with customer service representatives, office coworkers, physicians/therapists, and so many other different people in average day. Humans are inherently social beings, so talking and listening to each other is a huge part of what we all do day-to-day.

7! The Importance of Everyday Conversations

LEARNING

OUTCOMES

1. Realize the importance of conversation.
2. Recognize the motives and needs for interpersonal communication.
3. Discern conversation habits.

Most of us spend a great deal of our day interacting with other people through what is known as a conversation. According to Judy Apps, the word “conversation” is comprised of the words *con* (with)

and *versare* (turn): “conversation is turn and turnabout – you alternate.”¹ As such, a conversation isn’t a monologue or singular speech act; it’s a dyadic process where two people engage with one another in interaction that has multiple turns. Philosophers have been writing about the notion of the term “conversation” and its importance in society since the written word began.² For our purposes, we will leave the philosophizing to the philosophers and start with the underlying assumption that conversation is an important part of the interpersonal experience. Through conversations with others, we can build, maintain, and terminate relationships.

Coming up with an academic definition for the term “conversation” is not an easy task. Instead, Donald Allen and Rebecca Guy offer the following explanation: “Conversation is the primary basis of direct social relations between persons. As a process occurring in real-time, conversation constitutes a reciprocal and rhythmic interchange of verbal emissions. It is a sharing process which develops a common social experience.”³ From this explanation, a conversation is how people engage in social interaction in their day-to-day lives. From this perspective, a conversation is purely a verbal process. For our purposes, we prefer Susan Brennan’s definition: “Conversation is a joint activity in which two or more participants use linguistic forms and nonverbal signals to communicate interactively.”⁴ Brennan does differentiate conversations, which can involve two or more people, from dialogues, which only involve two people. For our purposes, this distinction isn’t critical. What is essential is that conversations are one of the most common forms of interpersonal communication.

There is growing concern that in today’s highly mediated world, the simple conversation is becoming a thing of the past. Sherry Turkle is one of the foremost researchers on how humans communicate using technology. She tells the story of an 18-year-old boy who uses texting for most of his fundamental interactions. The boy wistfully told Turkle, “Someday, someday, but certainly not now, I’d like to learn how to have a conversation.”⁵ When she asks Millennials across the nation what’s wrong with holding a simple conversation:

“I’ll tell you what’s wrong with having a conversation. It takes place in real-time and you can’t control what you’re going to say.” So that’s the bottom line. Texting, email, posting, all of these things let us present the self as we want to be. We get to edit, and that means we get to delete, and that means we get to retouch, the face, the voice, the flesh, the body—not too little, not too much, just right.⁶

Is this the world we now live in? Have people become so addicted to their technology that holding a simple conversation is becoming passé?

You should not take communication for granted. Reading this book, you will notice how much communication can be critical in our personal and professional lives. Communication is a vital component of our life. A few years ago, a prison decided to lessen the amount of communication inmates could have with each other. The prison administrators decided that they did not want inmates to share information. Yet, over time, the prisoners developed a way to communicate with each other using codes on walls and tapping out messages through pipes. Even when inmates were not allowed to talk to each other via face-to-face, they were still able to find other ways to communicate.⁷

Types of Conversations

David Angle argues that conversations can be categorized based on directionality (one-way or two-way) and tone/purpose (cooperative or competitive).⁸ One-way conversations are conversations where an individual is talking *at* the other person and not *with* the other person. Although these exchanges are technically conversations because of the inclusion of nonverbal feedback, one of the conversational

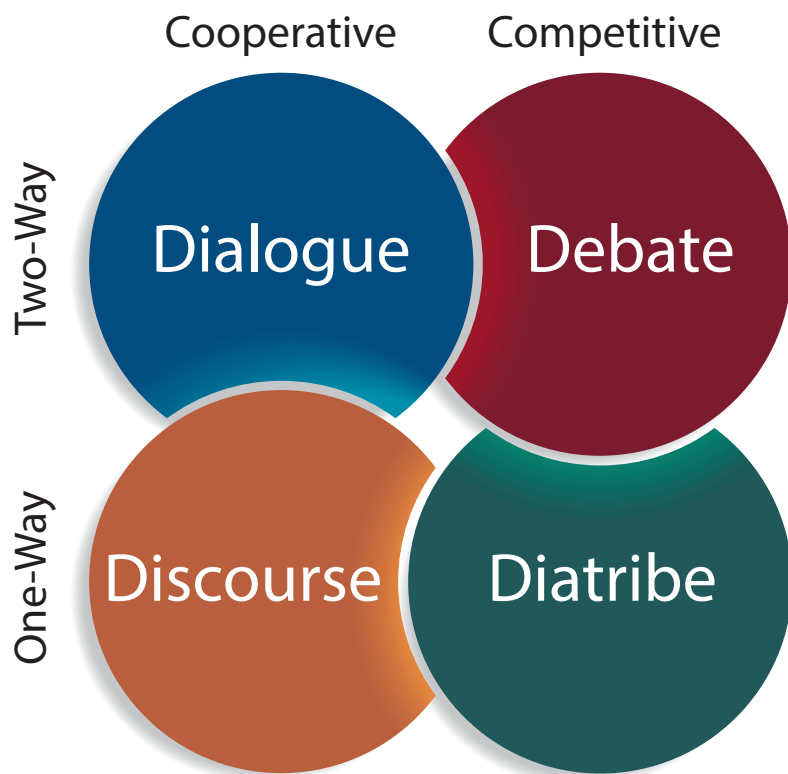

Figure 7.1 Four Types of Conversations

partners tends to monopolize the bulk of the conversation while the other partner is more of a passive receiver. Two-way conversations, on the other hand, are conversations where there is mutual involvement and interaction. In two-way conversations, people are actively talking, providing nonverbal feedback, and listening.

In addition to one vs. two-way interactions, Angle also believes that conversations can be broken down on whether they are cooperative or competitive. Cooperative conversations are marked by a mutual interest in what all parties within the conversation have to contribute. Conversely, individuals in competitive conversations are more concerned with their points of view than others within the conversation. Angle further breaks down his typology of conversations into four distinct types of conversation (Figure 7.1).

Discourse

The first type of conversation is one-way cooperative, which Angle labeled discourse. The purpose of a discourse conversation is for the sender to transmit information to the receiver. For example, a professor delivering a lecture or a speaker giving a speech.

Dialogue

The second type is what most people consider to be a traditional conversation: the dialogue (two-way, cooperative). According to Angle, “The goal is for participants to exchange information and build relationships with one another.”⁹ When you go on a first date, the general purpose of most of our conversations in this context is dialogue. If conversations take on one of the other three types, you could find yourself not getting a second date.

Debate

The third type of conversation is the two-way, competitive conversation, which Angle labels “debate.” The debate conversation is less about information giving and more about persuading. From this perspective, debate conversations occur when the ultimate goal of the conversation is to win an argument or persuade someone to change their thoughts, values, beliefs, and behaviors. Imagine you’re sitting in a study group and you’re trying to advocate for a specific approach to your group’s project. In this case, your goal is to persuade the others within the conversation to your point-of-view.

Diatribes

Lastly, Angle discusses the diatribe (one-way, competitive). The goal of the diatribe conversation is “to express emotions, browbeat those that disagree with you, and/or inspire those that share the same perspective.”¹⁰ For example, imagine that your best friend has come over to your dorm room, apartment, or house to vent about the grade they received on a test.

Communication Needs

There are many reasons why we communicate with each other, but what are our basic **communication needs**? The first reason why we communicate is for physical needs. Research has shown that we need to communicate with others because it keeps us healthier. There has been a direct link to mental and physical health. For instance, it has been shown that people who have cancer, depression, and even the common cold, can alleviate their symptoms simply by communicating with others. People who communicate their problems, feelings, and thoughts with others are less likely to hold grudges, anger, hostility, which in turn causes less stress on their minds and their bodies.

Another reason why we communicate with others is that it shapes who we are or identity needs. Perhaps you never realized that you were funny until your friends told you that you were quite humorous. Sometimes, we become who we are based on what others say to us and about us. For instance, maybe your mother told you that you are a gifted writer. You believe that information because you were told that by someone you respected. Thus, communication can influence the way that we perceive ourselves.

The third reason we communicate is for social needs. We communicate with others to initiate, maintain, and terminate relationships with others. These relationships may be personal or professional. In either case, we have motives or objectives for communicating with other people. The concept of **communication motives** was created by Rebecca Rubin. She found that there are six main reasons why individuals communicate with each other: control, relaxation, escape, inclusion, affection, and pleasure.

Control motives are means to gain compliance. Relaxation motives are ways to rest or relax. Escape motives are reasons for diversion or avoidance of other activities. Inclusion motives are ways to express emotion and to feel a link to the other person. Affection motives are ways to express one’s love and caring for another person. Pleasure motives are ways to communicate for enjoyment and excitement.

To maintain our daily routine, we need to communicate with others. The last reason we communicate is for practical needs. To exchange information or solve problems, we need to talk to others. Communication can prevent disasters from occurring. To create and/or sustain a daily balance in our lives, we need to communicate with other people. Hence, there is no escaping communication. We do it all the time.

Key Takeaways

- Communication is very important, and we should not take it for granted.
- There are six communication motives: control, affection, relaxation, pleasure, inclusion, and escape. There are four communication needs: physical, identity, social, and practical.
- Communication habits are hard to change.

Exercises

- Imagine if you were unable to talk to others verbally in a face-to-face situation. How would you adapt your communication so that you could still communicate with others? Why would you pick this method?
- Create a list of all the reasons you communicate and categorize your list based on communication motives and needs. Why do you think you communicate in the way that you do?
- Reflect on how you introduce yourself in a new situation. Write down what you typically say to a stranger. You can role play with a friend and then switch roles. What did you notice? How many of those statements are habitual? Why?

7.2 Sharing Personal Information

LEARNING OUTCOMES

1. Describe motives for self-disclosure.
2. Appreciate the process of self-disclosure.
3. Explain the consequences of self-disclosure.
4. Draw and explain the Johari Window.

One of the primary functions of conversations is sharing information about ourselves. In Chapter 2, we discussed Berger and Calabrese's Uncertainty Reduction Theory (URT).¹¹ One of the basic axioms of URT is that, as verbal communication increases between people when they first meet, the level of uncertainty decreases. Specifically, the type of verbal communication generally discussed in initial interactions is called self-disclosure.¹² **Self-disclosure** is the process of purposefully communicating information about one's self. Sidney Jourard sums up self-disclosure as permitting one's "true self" to be known to others.¹³

As we introduce the concept of self-disclosure in this section, it's important to realize that there is no right or wrong way to self-disclose. Different people self-disclose for a wide range of different reasons and purposes. Emmi Ignatius and Marja Kokkonen found that self-disclosure can vary for several reasons:¹⁴

- Personality traits (shy people self-disclose less than extraverted people)
- Cultural background (Western cultures disclose more than Eastern cultures)
- Emotional state (happy people self-disclose more than sad or depressed people)
- Biological sex (females self-disclose more than males)
- Psychological gender (androgynous people were more emotionally aware, topically involved, and invested in their interactions; feminine individuals disclosed more in social situations, and masculine individuals generally did not demonstrate meaningful self-disclosure across contexts)
- Status differential (lower status individuals are more likely to self-disclose personal information than higher-status individuals)
- Physical environment (soft, warm rooms encourage self-disclosure while hard, cold rooms

discourage self-disclosure)

- Physical contact (touch can increase self-disclosure, unless the other person feels that their personal space is being invaded, which can decrease self-disclosure)
- Communication channel (people often feel more comfortable self-disclosing when they're not face-to-face; e.g., on the telephone or through computer-mediated communication)

As you can see, there are quite a few things that can impact how self-disclosure happens when people are interacting during interpersonal encounters.

Motives for Self-Disclosure

So, what ultimately motivates someone to self-disclose? Emmi Ignatius and Marja Kokkonen found two basic reasons for self-disclosure: social integration and impression management.¹⁵

Social Integration

The first reason people self-disclose information about themselves is simply to develop interpersonal relationships. Part of forming an interpersonal relationship is seeking to demonstrate that we have commonality with another person. For example, let's say that it's the beginning of a new semester, and you're sitting next to someone you've never met before. You quickly strike up a conversation while you're waiting for the professor to show up. During those first few moments of talking, you're going to try to establish some kind of commonality. Maybe you'll learn that you're both communication majors or that you have the same favorite sports team or band. Self-disclosure helps us find these areas where we have similar interests, beliefs, values, attitudes, etc.... As humans, we have an innate desire to be social and meet people. And research has shown us that self-disclosure is positively related to liking.¹⁶ The more we self-disclose to others, the more they like us and vice versa.

However, we should mention that appropriate versus inappropriate self-disclosures depends on the nature of your relationship. When we first meet someone, we do not expect that person to start self-disclosing their deepest darkest secrets. When this happens, then we experience an expectancy violation. Judee Burgoon conceptualized expectancy violation theory as an understanding of what happens when an individual within an interpersonal interaction violates the norms for that interaction.^{17,18} Burgoon's original expectancy violation theory (EVT) primarily analyzed what happened when individuals communicated nonverbally in a manner that was unexpected (e.g., standing too close while talking). Over the years, EVT has been expanded by many scholars to look at a range of different situations when communication expectations are violated.¹⁹ As a whole, EVT predicts that when individuals violate the norms of communication during an interaction, they will evaluate that interaction negatively. However, this does depend on the nature of the initial relationship. If we've been in a relationship with someone for a long time or if it's someone we want to be in a relationship with, we're more likely to overlook expectancy violations.

So, how does this relate to self-disclosure? Mostly, there are ways that we self-disclose that are considered "normal" during different types of interactions and contexts. What you disclose to your best friend will be different than what you disclose to a stranger at the bus station. What you disclose to your therapist will be different than what you disclose to your professor. When you meet a stranger, the types of self-disclosure tend to be reasonably common topics: your major, sports teams, bands, the weather, etc. If, however, you decide to self-disclose information that is overly personal, this would be perceived as a violation of the types of topics that are normally disclosed during initial interactions. As such, the other person is probably going to try to get out of that conversation pretty quickly. When people

disclose information that is inappropriate to the context, those interactions will generally be viewed more negatively.²⁰

From a psychological standpoint, finding these commonalities with others helps reinforce our self-concept. We find that others share the same interests, beliefs, values, attitudes, etc., which demonstrates that how we think, feel, and behave are similar to those around us. Admittedly, it's not like we do all of this consciously.²¹

Impression Management

The second reason we tend to self-disclose is to portray a specific impression of who we are as individuals to others. **Impression management** is defined as “the attempt to generate as favorable an impression of ourselves as possible, particularly through both verbal and nonverbal techniques of self-presentation.”²² Basically, we want people to view us in a specific way, so we communicate with others in an attempt to get others to see us that way. Research has found we commonly use six impression management techniques during interpersonal interactions: self-descriptions, accounts, apologies, entitlements and enhancements, flattery, and favors.^{23,24,25}

Self-Descriptions

The first type of impression management technique we can use is self-descriptions, or talking about specific characteristics of ourselves. For example, if you want others to view you professionally, you would talk about the work that you've accomplished. If you want others to see you as someone fun to be around, you will talk about the parties you've thrown. In both of these cases, the goal is to describe ourselves in a manner that we want others to see.

Accounts

The second type of impression management is accounts. Accounts “are explanations of a predicament-creating event designed to minimize the apparent severity of the predicament.”²⁶ According to William Gardner and Mark Martinko, in accounts, “actors may deny events occurred, deny causing events, offer excuses, or justify incidents.”²⁷ Basically, accounts occur when an individual is attempting to explain something that their interactant may already know.

For the purposes of initial interactions, imagine that you're on a first date and your date has heard that you're a bit of a “player.” An account may be given to downplay your previous relationships or explain away the rumors about your previous dating history.

Apologies

The third type of impression management tactics is apologies. According to Barry Schlenker, apologies are “are designed to convince the audience that the undesirable event should not be considered a fair representation of what the actor is ‘really like.’”²⁸ An apology occurs when someone admits that they have done something wrong while attempting to downplay the severity of the incident or the outcomes.

Imagine you just found out that a friend of yours told a personal story about you during class as an example. Your friend could offer an apology, admitting that they shouldn't have told the story, but also emphasize that it's not like anyone in the class knows who you are. In essence, the friend admits that they are wrong, but also downplays the possible outcomes from the inappropriate disclosure of your story.

Entitlements and Enhancements

The fourth type of impression management tactic is the use of entitlements and enhancements. Entitlements and enhancements are “designed to explain a desirable event in a way that maximizes the desirable implications for the actor.”²⁹ Primarily, “entitlements are designed to maximize an actor’s apparent responsibility for an event; enhancements are designed to maximize the favorability of an event itself.”³⁰ In this case, the goal is to make one’s self look even better than maybe they actually are.

For our examples, let’s look at entitlements and enhancements separately. For an example of an entitlement, imagine that you’re talking to a new peer in class and they tell you about how they single-handedly organized a wildly popular concert that happened over the weekend. In this case, the individual is trying to maximize their responsibility for the party in an effort to look good.

For an example of an enhancement, imagine that in the same scenario, the individual talks less about how they did the event single-handedly and talks more about how amazing the event itself was. In this case, they’re aligning themselves with the event, so the more amazing the event looks, the better you’ll perceive them as an individual.

Flattery

The fifth impression management tactic is the use of flattery, or the use of compliments to get the other person to like you more. In this case, there is a belief that if you flatter someone, they will see you in a better light. Imagine there’s a new player on your basketball team. Almost immediately, they start complimenting you on your form and how they wish they could be as good as you are. In this case, the person may be completely honest, but the use of flattery will probably get you to see that person more positively as well.

Favors

The last tactic that researchers have described for impression management is favors. Favors “involve doing something nice for someone to gain that person’s approval.”³¹ One way that we get others to like us is to do things for them. If we want our peers in class to like us, then maybe we’ll share our notes with them when they’re absent. We could also volunteer to let someone use our washer and dryer if they don’t have one. There are all kinds of favors that we can do for others. Although most of us don’t think of favors as tactics for managing how people perceive us, they have an end result that does.

Social Penetration Theory

In 1973, Irwin Altman and Dalmas Taylor were interested in discovering how individuals become closer to each other.³² They believed that the method of self-disclosure was similar to social penetration and hence created the **social penetration theory**. This theory helps to explain how individuals gradually become more intimate based on their communication behaviors. According to the social penetration theory, relationships begin when individuals share non-intimate layers and move to more intimate layers of personal information.³³

Altman and Taylor believed that individuals discover more about others through self-disclosure. How people comprehend others on a deeper level helps us also gain a better understanding of ourselves. The researchers believe that penetration happens gradually. The scholars describe their theory visually like an onion with many rings or levels.³⁴ A person’s personality is like an onion because it has many layers

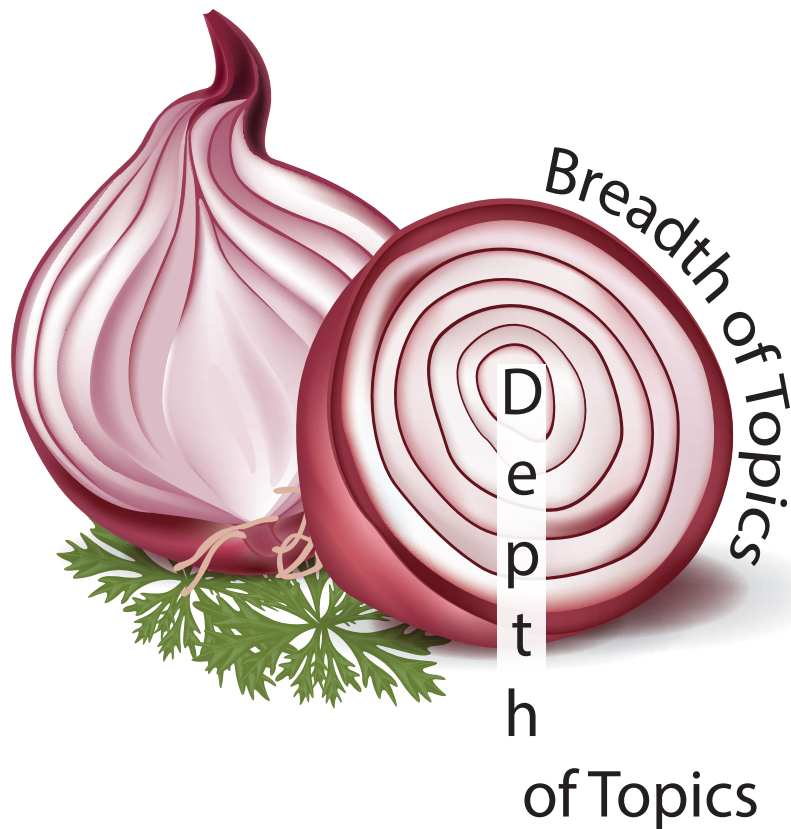

Figure 7.2 Social Penetration Theory

(Figure 7.2). We have an outer layer that everyone can see (e.g., hair color or height), and we have very personal layers that people cannot see (e.g., our dreams and career aspirations). Three factors affect what people chose to disclose. The first is personal characteristics (e.g., introverted or extraverted). The second is the possibility of any reward or cost with disclosing to the other person (e.g., information might have repercussions if the receiver does not like or agree with you). And the third is the situational context (e.g., telling your romantic partner that you want to terminate the relationship on your wedding day).

When people first meet each other, they start from their outer rings and slowly move towards the core. The researchers described how people typically would go through various stages to become closer. The first stage is called the orientation stage, where people communicate on very superficial

matters like the weather. The next stage is the exploratory affective stage, where people will disclose more about their feelings about normal topics like favorite foods or movies. Many of our friendships remain at this stage. The third stage is more personal and called the affective stage, where people engage in more private topics. The fourth stage is the stable stage, where people will share their most intimate details. The last stage is not obligatory and does not necessarily happen in every relationship, it is the depenetration stage, where people start to decrease their disclosures.

Social penetration theory also contains two different aspects. The first aspect is breadth, which refers to what topics individuals are willing to talk about with others. For instance, some people do not like to talk about religion and politics because it is considered inappropriate. The second aspect is depth, which refers to how deep a person is willing to go in discussing certain topics. For example, some people don't mind sharing information about themselves in regards to their favorite things. Still, they may not be willing to share their most private thoughts about themselves because it is too personal. The researchers believe that by self-disclosing to others both in breadth and depth, then it could lead to more relational closeness.

Johari Window

The name "Johari" is a combination of the two researchers who originated the concept: Joseph Luft (Jo) and Harrington Ingham (hari).³⁵ The basic idea behind the Johari Window is that we build trust in our interpersonal relationships as we self-disclose revealing information about ourselves, and we learn more about ourselves as we receive feedback from the people with whom we are interacting. As you

can see in Figure 7.3, the Johari Window is represented by four window panes. Two window panes refer to ourselves, and two refer to others. First, when discussing ourselves, we have to be aware that some things about ourselves are known to us, and others are not. For example, we may be completely aware of the fact that we are extraverted and love talking to people (known to self). However, we may not be aware of how others tend to view our extraversion as positive or negative (unknown to self). The second part of the window is what is known to others and unknown to others. For example, some common information known to others includes your height, weight, hair color, etc. At the same time, there is a bunch of information that people don't know about us: deepest desires, joys, goals in life, etc. Ultimately, the Johari Window breaks this into four different quadrants (Figure 7.3).

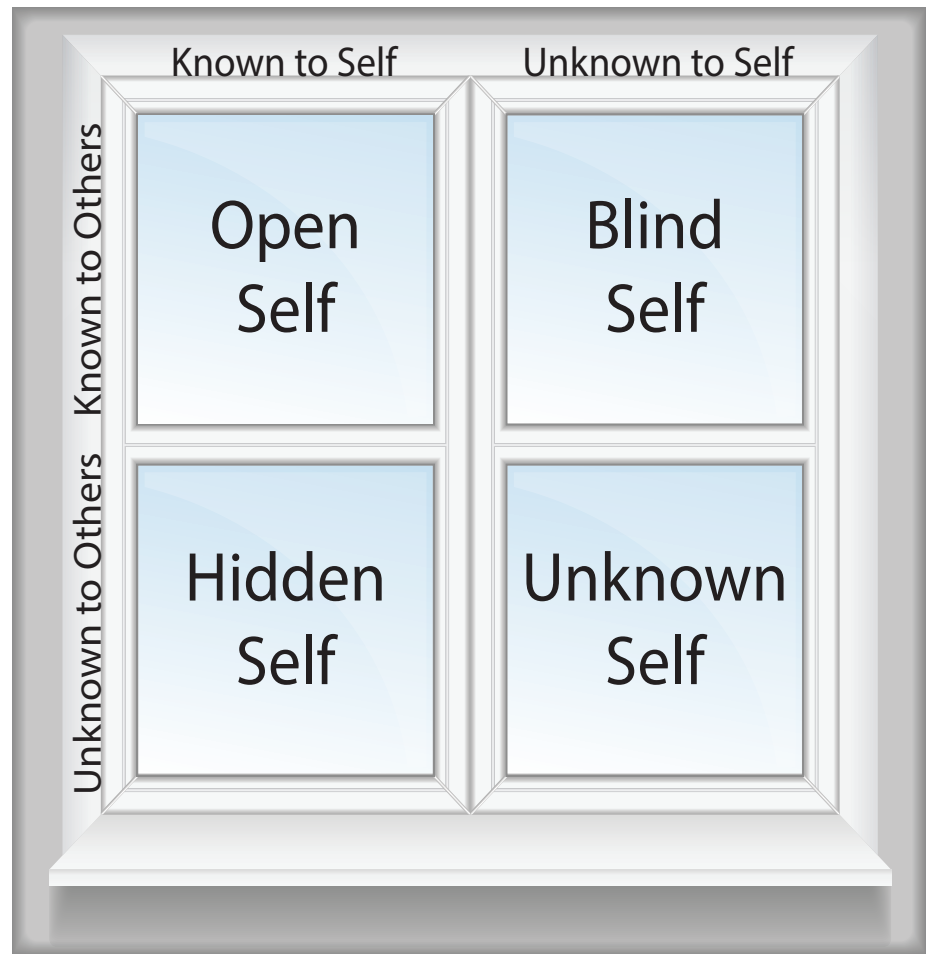

Figure 7.3 Johari Window

Open Self

The first quadrant of the Johari Window is the open self, or when information is known to both ourselves and others. Although some facets are automatically known, others become known as we disclose more and more information about ourselves with others. As we get to know people and self-disclose and increasingly deeper levels, the open self quadrant grows. For the purposes of thinking about discussions and self-disclosures, the open self is where the bulk of this work ultimately occurs.

Information in the open self can include your attitudes, beliefs, behaviors, emotions/feelings, experiences, and values that are known to both the person and to others. For example, if you wear a religious symbol around your neck (Christian Cross, Jewish Star of David, Islamic Crescent Moon and Star, etc.), people will be able to ascertain certain facts about your religious beliefs immediately.

Hidden Self

The second quadrant is what is known to ourselves but is not known to others. All of us have personal information we may not feel compelled to reveal to others. For example, if you're a member of the LGBTQIA+ community, you may not feel the need to come out during your first encounter with someone new. It's also possible that you'll keep this information from your friends and family for a long

time.

Think about your own life, what types of things do you keep hidden from others? One of the reasons we keep things hidden is because it's hard to open ourselves up to being vulnerable. Typically, the hidden self will decrease as a relationship grows. However, if someone ever violates our trust and discusses our hidden self with others, we are less likely to keep disclosing this information in the future. If the trust violation is extreme enough, we may discontinue that relationship altogether.

Blind Self

The third quadrant is called the blind self because it's what we don't know about ourselves that is known by others. For example, during an initial interaction, we may not know how the other person is reacting to us. We may think that we're coming off as friendly, but the other person may be perceiving us as shy or even pushy. One way to decrease the blind self is by soliciting feedback from others. As others reveal more of our blind selves, we can become more self-aware of how others perceive us.

One problem with the blind self is that how people view us and how we view ourselves can often be radically different. For example, people may perceive you as cocky, but in reality, you're scared to death. It's important to decrease the blind self during our interactions with others, because how people view us will determine how they interact with us.

Unknown Self

Lastly, we have the unknown self, or when information is not known by ourselves or others. The unknown self can include aptitudes/talents, attitudes/feelings, behaviors, capabilities, etc. that are unknown to us or others. For example, you may have a natural talent to play the piano. Still, if you've never sat down in front of a piano, neither you nor others would have any way of knowing that you have the aptitude/talent for playing the piano. Sometimes parts of the unknown self are just under the surface and will arise with time and in the right contexts, but other times no one will ever know these unknown parts.

One other area that can affect the unknown self involves prior experiences. It's possible that you experienced a traumatic event that closes you down in a specific area. For example, imagine that you are an amazing writer, but someone, when you were in the fourth grade, made fun of a story you wrote, so you never tried writing again. In this case, the aptitude/talent for writing has been stamped out because of that one traumatic experience as a child. Sadly, a lot of us probably have a range of aptitudes/talents, attitudes/feelings, behaviors, capabilities, etc. that were stopped because of traumas throughout our lives.

Key Takeaways

- We self-disclose to share information with others. It allows us to express our thoughts, feelings, and behaviors.
- Self-disclosure includes levels of disclosure, reciprocity in disclosure, and appropriate disclosure.
- There can be positive and negative consequences of self-disclosure. These consequences can strengthen how you feel or create distance between you and someone else.
- The Johari Window is a model that helps to illustrate self-disclosure and the

process by which you interact with other people.

Exercises

- Create a self-penetration diagram for yourself. What topics are you open to talk about? What are you not willing to discuss? Then compare with another student in class. How were you similar or dissimilar? Why do you think these differences/similarities exist?
- Think of a time when you've used the six different impression management techniques. How effective were you with each technique? What could you have done differently?
- Draw your own Johari Window. Fill in each of the window panes with a topic of self-disclosure. You will probably need to ask a close friend or family member to help you with the unknown self pane. Why did you put what you put? Does it make sense? Why?

7.3 Listening

LEARNING OUTCOMES

1. Differentiate between hearing and listening.
2. Understand how to listen effectively.
3. Recognize the different types of listening.

When it comes to daily communication, we spend about 45% of our listening, 30% speaking, 16% reading, and 9% writing.³⁶ However, most people are not entirely sure what the word “listening” is or how to do it effectively.

Hearing Is Not Listening

Hearing refers to a passive activity where an individual perceives sound by detecting vibrations through an ear. Hearing is a physiological process that is continuously happening. We are bombarded by sounds all the time. Unless you are in a sound-proof room or are 100% deaf, we are constantly hearing sounds. Even in a sound-proof room, other sounds that are normally not heard like a beating heart or breathing will become more apparent as a result of the blocked background noise.

Listening, on the other hand, is generally seen as an active process. Listening is “focused, concentrated attention for the purpose of understanding the meanings expressed by a [source].”³⁷ From this perspective, hearing is more of an automatic response when your ear perceives information; whereas, listening is what happens when we purposefully attend to different messages.

We can even take this a step further and differentiate normal listening from critical listening. **Critical listening** is the “careful, systematic thinking and reasoning to see whether a message makes sense in light of factual evidence.”³⁸ From this perspective, it's one thing to attend to someone's message, but something very different to analyze what the person is saying based on known facts and evidence.

Let's apply these ideas to a typical interpersonal situation. Let's say that you and your best friend are

having dinner at a crowded restaurant. Your ear is going to be attending to a lot of different messages all the time in that environment, but most of those messages get filtered out as “background noise,” or information we don’t listen to at all. Maybe then your favorite song comes on the speaker system the restaurant is playing, and you and your best friend both attend to the song because you both like it. A minute earlier, another song could have been playing, but you tuned it out (hearing) instead of taking a moment to enjoy and attend to the song itself (listen). Next, let’s say you and your friend get into a discussion about the issues of campus parking. Your friend states, “There’s never any parking on campus. What gives?” Now, if you’re critically listening to what your friend says, you’ll question the basis of this argument. For example, the word “never” in this statement is problematic because it would mean that the campus has zero available parking, which is probably not the case. Now, it may be difficult for your friend to find a parking spot on campus, but that doesn’t mean that there’s “never any parking.” In this case, you’ve gone from just listening to critically evaluating the argument your friend is making.

Model of Listening

Judi Brownell created one of the most commonly used models for listening.³⁹ Although not the only model of listening that exists, we like this model because it breaks the process of hearing down into clearly differentiated stages: hearing, understanding, remembering, interpreting, evaluating, and responding (Figure 7.4).

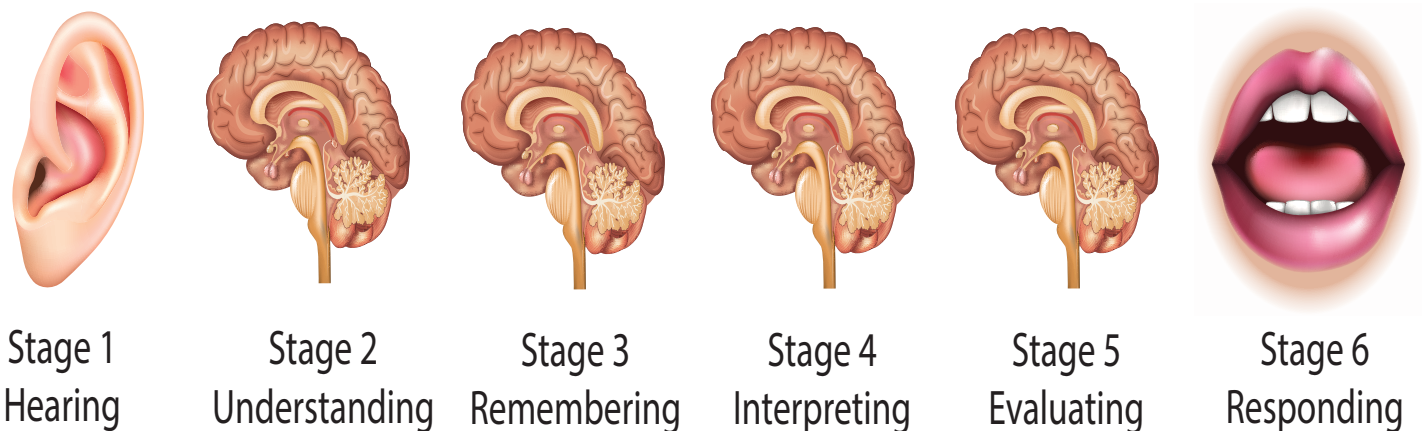

Figure 7.4 HURIER Model of Listening

Hearing

From a fundamental perspective, for listening to occur, an individual must attend to some kind of communicated message. Now, one can argue that hearing should not be equated with listening (as we did above), but it is the first step in the model of listening. Simply, if we don’t attend to the message at all, then communication never occurred from the receiver’s perspective.

Imagine you’re standing in a crowded bar with your friends on a Friday night. You see your friend Darry and yell her name. In that instant, you, as a source of a message, have attempted to send a message. If Darry is too far away, or if the bar is too loud and she doesn’t hear you call her name, then Darry has not engaged in stage one of the listening model. You may have tried to initiate communication, but the receiver, Darry, did not know that you initiated communication.

Now, to engage in mindful listening, it’s important to take hearing seriously because of the issue of intention. If we go into an interaction with another person without really intending to listening to what

they have to say, we may end up being a passive listener who does nothing more than hear and nod our heads. Remember, mindful communication starts with the premise that we must think about our intentions and be aware of them.

Understanding

The second stage of the listening model is understanding, or the ability to comprehend or decode the source's message. When we discussed the basic models of human communication in Chapter 2, we discussed the idea of decoding a message. Simply, decoding is when we attempt to break down the message we've heard into comprehensible meanings. For example, imagine someone coming up to you asking if you know, "Tintinnabulation of vacillating pendulums in inverted, metallic resonant cups." Even if you recognize all of the words, you may not completely comprehend what the person is even trying to say. In this case, you cannot decode the message. Just as an FYI, that means "jingle bells."

Remembering

Once we've decoded a message, we have to actually remember the message itself, or the ability to recall a message that was sent. We are bombarded by messages throughout our day, so it's completely possible to attend to a message and decode it and then forget it about two seconds later.

For example, I always warn my students that my brain is like a sieve. If you tell me something when I'm leaving the class, I could easily have forgotten what you told me three seconds later because my brain switches gear to what I'm doing next: I run into another student into in the hallway; another thought pops into my head; etc. As such, I always recommend emailing me important things, so I don't forget them. In this case, it's not that I don't understand the message; I just get distracted, and my remembering process fails me. This problem plagues all of us.

Interpreting

The next stage in the HURIER Model of Listening is interpreting. "Interpreting messages involves attention to all of the various speaker and contextual variables that provide a background for accurately perceived messages."⁴⁰ So, what do we mean by contextual variables? A lot of the interpreting process is being aware of the nonverbal cues (both oral and physical) that accompany a message to accurately assign meaning to the message.

Imagine you're having a conversation with one of your peers, and he says, "I love math." Well, the text itself is demonstrating an overwhelming joy and calculating mathematical problems. However, if the message is accompanied by an eye roll or is said in a manner that makes it sound sarcastic, then the meaning of the oral phrase changes. Part of interpreting a message then is being sensitive to nonverbal cues.

Evaluating

The next stage is the evaluating stage, or judging the message itself. One of the biggest hurdles many people have with listening is the evaluative stage. Our personal biases, values, and beliefs can prevent us from effectively listening to someone else's message.

Let's imagine that you despise a specific politician. It's gotten to the point where if you hear this politician's voice, you immediately change the television channel. Even hearing other people talk about this politician causes you to tune out completely. In this case, your own bias against this politician

prevents you from effectively listening to their message or even others' messages involving this politician. Overcoming our own biases against the source of a message or the content of a message in an effort to truly listen to a message is not easy. One of the reasons listening is a difficult process is because of our inherent desire to evaluate people and ideas.

When it comes to evaluating another person's message, it's important to remember to be mindful. As we discussed in Chapter 1, to be a mindful communicator, you must listen with an open ear that is nonjudging. Too often, we start to evaluate others' messages with an analytical or cold quality that is antithetical to being mindful.

Responding

In Figure 7.4, hearing is represented by an ear, the brain represents the next four stages, and a person's mouth represents the final stage. It's important to realize that effective listening starts with the ear and centers in the brain, and only then should someone provide feedback to the message itself. Often, people jump from hearing and understanding to responding, which can cause problems as they jump to conclusions that have arisen by truncated interpretation and evaluation.

Ultimately, how we respond to a source's message will dictate how the rest of that interaction will progress. If we outright dismiss what someone is saying, we put up a roadblock that says, "I don't want to hear anything else." On the other hand, if we nod our heads and say, "tell me more," then we are encouraging the speaker to continue the interaction. For effective communication to occur, it's essential to consider how our responses will impact the other person and our relationship with that other person.

Overall, when it comes to being a mindful listener, it's vital to remember **COAL**: curiosity, openness, acceptance, and love.⁴¹ We need to go into our interactions with others and try to see things from their points of view. When we engage in **COAL**, we can listen mindfully and be in the moment.

Taxonomy of Listening

Now that we've introduced the basic concepts of listening, let's examine a simple taxonomy of listening that was created by Andrew Wolvin and Carolyn Coakley.⁴² The basic premise of the Wolvin and Coakley taxonomy of listening is that there are fundamental parts to listening and then higher-order aspects of listening (Figure 7.5). Let's look at each of these parts separately.

Discriminative

The base level of listening is what Wolvin and Coakley called discriminative listening, or distinguishing between auditory and visual stimuli and determining which to actually pay attention to. In many ways, discriminative listening focuses on how hearing and seeing a wide range of different stimuli can be filtered and used.

We're constantly bombarded by a variety of messages in our day-to-day lives. We have to discriminate between which messages we want to pay attention to and which ones we won't. As a metaphor, think of discrimination as your email inbox. Every day you have to filter out messages (aka spam) to find the messages you want to actually read. In the same way, our brains are constantly bombarded by messages, and we have to filter some in and most of them out.

Comprehensive

If we achieve discriminative listening, then we can progress to comprehensive listening. “Comprehensive listening requires the listener to use the discriminative skills while functioning to understand and recall the speaker’s information.”⁴³ If we go back and look at Figure 7.4, we can see that comprehensive listening essentially aligns with understanding and remembering.

Wolvin and Coakley argued that discriminative and comprehensive listening are foundational

levels of listening. If these foundational levels of listening are met, then they can progress to the other three, higher-order levels of listening: therapeutic, critical, and appreciative.

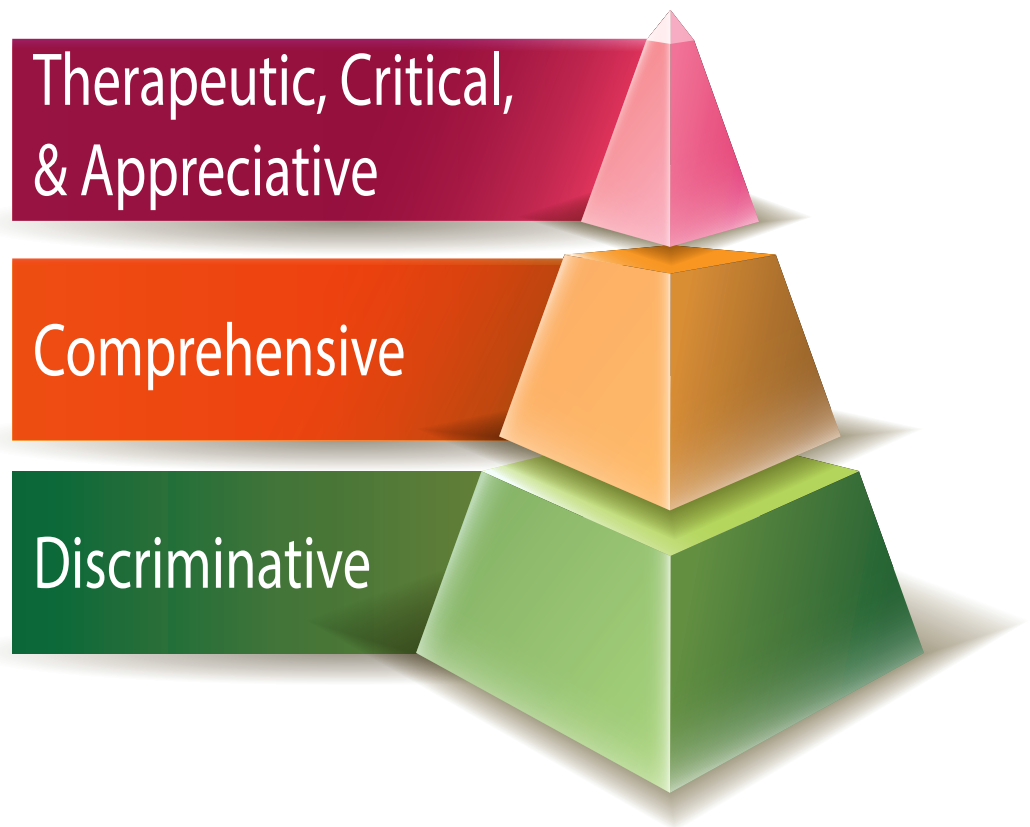

Figure 7.5 Taxonomy of Listening

Therapeutic

Therapeutic listening occurs when an individual is a sounding board for another person during an interaction. For example, your best friend just fought with their significant other and they’ve come to you to talk through the situation.

Critical

The next aspect of listening is critical listening, or really analyzing the message that is being sent. Instead of just being a passive receiver of information, the essential goal of listening is to determine the acceptability or validity of the message(s) someone is sending.

Appreciative

Lastly, we have appreciative listening, which is when someone simply enjoys the act of listening or the message being sent. For example, let’s say you’re watching a Broadway musical or play or even a new movie at the cinema. While you may be engaged critically, you also may be simply appreciative and enjoying the act of listening to the message.

Listening Styles

Now that we have a better understanding of how listening works, let’s talk about four different styles of

listening researchers have identified. Kittie Watson, Larry Barker, and James Weaver defined listening styles as “attitudes, beliefs, and predispositions about the how, where, when, who, and what of the information reception and encoding process.”⁴⁴ Watson et al. identified four distinct listening styles: people, content, action, and time. Before progressing to learning about the different listening styles, take a minute to complete the measure in Table 7.1, The Listening Style Questionnaire. The Listening Style Questionnaire is based on the original work of Watson, Barker, and Weaver.⁴⁵

The Four Listening Styles

People

The first listening style is the people-oriented listening style. People-oriented listeners tend to be more focused on the person sending the message than the content of the message. As such, people-oriented listeners focus on the emotional states of senders of information. One way to think about people-oriented listeners is to see them as highly compassionate, empathic, and sensitive, which allows them to put themselves in the shoes of the person sending the message.

People-oriented listeners often work well in helping professions where listening to the person and understanding their feelings is very important (e.g., therapist, counselor, social worker). People-oriented listeners are also very focused on maintaining relationships, so they are good at casual conversation where they can focus on the person.

Action

The second listening style is the action-oriented listener. Action-oriented listeners are focused on what the source wants. The action-oriented listener wants a source to get to the point quickly. Instead of long, drawn-out lectures, the action-oriented speaker would prefer quick bullet points that get to what the source desires. Action-oriented listeners “tend to preference speakers that construct organized, direct, and logical presentations.”⁴⁶

When dealing with an action-oriented listener, it’s important to realize that they want you to be logical and get to the point. One of the things action-oriented listeners commonly do is search for errors and inconsistencies in someone’s message, so it’s important to be organized and have your facts straight.

Content

The third type of listener is the content-oriented listener, or a listener who focuses on the content of the message and process that message in a systematic way. Of the four different listening styles, content-oriented listeners are more adept at listening to complex information. Content-oriented listeners “believe it is important to listen fully to a speaker’s message prior to forming an opinion about it (while action listeners tend to become frustrated if the speaker is ‘wasting time’).”⁴⁷

When it comes to analyzing messages, content-oriented listeners really want to dig into the message itself. They want as much information as possible in order to make the best evaluation of the message. As such, “they want to look at the time, the place, the people, the who, the what, the where, the when, the how ... all of that. They don’t want to leave anything out.”⁴⁸

Time

The final listening style is the time-oriented listening style. Time-oriented listeners are sometimes referred to as “clock watchers” because they’re always in a hurry and want a source of a message to speed things up a bit. Time-oriented listeners “tend to verbalize the limited amount of time they are willing or able to devote to listening and are likely to interrupt others and openly signal disinterest.”⁴⁹

They often feel that they are overwhelmed by so many different tasks that need to be completed (whether real or not), so they usually try to accomplish multiple tasks while they are listening to a source. Of course, multitasking often leads to someone’s attention being divided, and information being missed.

Thinking About the Four Listening Types

Kina Mallard broke down the four listening styles and examined some of the common positive characteristics, negative characteristics, and strategies for communicating with the different listening styles (Table 7.2).⁵⁰

People-Oriented Listener		
<i>Positive Characteristics</i>	<i>Negative Characteristics</i>	<i>Strategies for Communicating with People-Oriented Listeners</i>
Show care and concern for others	Over involved in feelings of others	Use stories and illustrations to make points
Are nonjudgmental	Avoid seeing faults in others	Use “we” rather than “I” in conversations
Provide clear verbal and nonverbal feedback signals	Internalize/adopt emotional states of others	Use emotional examples and appeals
Are interested in building relationships	Are overly expressive when giving feedback	Show some vulnerability when possible
Notice others’ moods quickly	Are nondiscriminating in building relationships	Use self-effacing humor or illustrations

Action-Oriented Listeners		
<i>Positive Characteristics</i>	<i>Negative Characteristics</i>	<i>Strategies for Communicating with Action-Oriented Listeners</i>
Get to the point quickly	Tend to be impatient with rambling speakers	Keep main points to three or fewer
Give clear feedback concerning expectations	Jump ahead and reach conclusions quickly	Keep presentations short and concise
Concentrate on understanding task	Jump ahead or finishes thoughts of speakers	Have a step-by-step plan and label each step

Instructions: Read the following questions and select the answer that corresponds with how you tend to listen to public speeches. Do not be concerned if some of the items appear similar. Please use the scale below to rate the degree to which each statement applies to you:

Strongly Disagree 1	Disagree 2	Neutral 3	Agree 4	Strongly Agree 5
-------------------------------	----------------------	---------------------	-------------------	----------------------------

1. I am very attuned to public speaker's emotions while listening to them.
2. I keep my attention on a public speaker's feelings why they speak.
3. I listen for areas of similarity and difference between me and a public speaker.
4. I generally don't pay attention to a speaker's emotions.
5. When listening to a speaker's problems, I find myself very attentive.
6. I prefer to listen to people's arguments while they are speaking.
7. I tend to tune out technical information when a speaker is speaking.
8. I wait until all of the arguments and evidence is presented before judging a speaker's message.
9. I always fact check a speaker before forming an opinion about their message.
10. When it comes to public speaking, I want a speaker to keep their opinions to themselves and just give me the facts.
11. A speaker needs to get to the point and tell me why I should care.
12. Unorganized speakers drive me crazy.
13. Speakers need to stand up, say what they need to say, and sit down.
14. If a speaker wants me to do something, they should just say it directly.
15. When a speaker starts to ramble on, I really start to get irritated.
16. I have a problem listening to someone give a speech when I have other things to do, places to be, or people to see.
17. When I don't have time to listen to a speech, I have no problem telling someone.
18. When someone is giving a speech, I'm constantly looking at my watch or clocks in the room.
19. I avoid speeches when I don't have the time to listen to them.
20. I have no problem listening to a speech even when I'm in a hurry.

Scoring

People-Oriented Listener

A: Add scores for items 1, 2, 3, 5 and place total on line. _____

B: Place score for item 4 on the line. _____

C: Take the total from A and add 6 to the score. Place the new number on the line. _____

Step Four: Now subtract B from C. Place your final score on the line.

Content-Oriented Listener

A: Add scores for items 6, 8, 9, 10 and place total on line.

B: Place score for item 7 on the line.

Take the total from A and add 6 to the score. Place the new number on the line.

Final Score: Now subtract B from C. Place your final score on the line.

Time-Oriented Listener

Final Score: Add items 11, 12, 13, 14, 15

Content-Oriented Listener

A: Add scores for items 16, 17, 19 and place total on line.

B. Add scores for items 18 & 20 and place total on line.

C: Take the total from A and add 12 to the score. Place the new number on the line.

Final Score: Now subtract B from C. Place your final score on the line.

Interpretation

For each of the four subscales, scores should be between 5 and 25. If your score is above 18, you are considered to have high levels of that specific listening style. If your score is below 12, you're considered to have low levels of that specific listening style.

Based On

Watson, K. W., Barker, L. L., & Weaver, J. B., III. (1992, March). *Development and validation of the Listener Preference Profile*. Paper presented at the International Listening Association in Seattle, WA

Table 7.1 Listening Style Questionnaire

Action-Oriented Listeners

Positive Characteristics

Help others focus on what's important

Encourage others to be organized and concise

Negative Characteristics

Minimize relationship issues and concerns

Ask blunt questions and appear overly critical

Strategies for Communicating with Action-Oriented Listeners

Watch for cues of disinterest and pick up vocal pace at those points or change subjects

Speak at a rapid but controlled rate

Content-Oriented Listeners

Positive Characteristics

Value technical information

Test for clarity and understanding

Encourage others to provide support for their ideas

Welcome complex and challenging information

Look at all sides of an issue

Negative Characteristics

Are overly detail oriented

May intimidate others by asking pointed questions

Minimize the value of nontechnical information

Discount information from nonexperts

Take a long time to make decisions

Strategies for Communicating with Content-Oriented Listeners

Use two-side arguments when possible

Provide hard data when available

Quote credible experts

Suggest logical sequences and plan

Use charts and graphs

Time-Oriented Listeners

Positive Characteristics

Manage and save time

Set time guidelines for meeting and conversations

Let others know listening-time requirements

Discourage wordy speakers

Negative Characteristics

Tend to be impatient with time wasters

Interrupt others

Let time affect their ability to concentrate

Rush speakers by frequently looking at watches/clock

Strategies for Communicating with Time-Oriented Listeners

Ask how much time the person has to listen

Try to go under time limits when possible

Be ready to cut out necessary examples and information

Be sensitive to nonverbal cues indicating impatience or a desire to leave

Time-Oriented Listeners

Positive Characteristics

Give cues to others when time is being wasted

Negative Characteristics

Limit creativity in others by imposing time pressures

Strategies for Communicating with Time-Oriented Listeners

Get to the bottom line quickly

Original Source: Mallard, K. S. (1999). Lending an ear: The chair's role as listener. *The Department Chair, 9*(3), 1-13.

Used with Permission from the Author

Table 7.2 Understanding the Four Listening Styles

Hopefully, this section has helped you further understand the complexity of listening. We should mention that many people are not just one listening style or another. It's possible to be a combination of different listening styles. However, some of the listening style combinations are more common. For example, someone who is action-oriented and time-oriented will want the bare-bones information so they can make a decision. On the other hand, it's hard to be a people-oriented listener and time-oriented listener because being empathic and attending to someone's feelings takes time and effort.

MINDFULNESS ACTIVITY



One of the hardest skills to master when it comes to mindfulness is mindful listening. To engage in mindful listening, Elaine Smookler recommends using the HEAR method:

1. **HALT** – Halt whatever you are doing and offer your full attention.
2. **ENJOY** – Enjoy a breath as you choose to receive whatever is being communicated to you—wanted or unwanted.
3. **ASK** – Ask yourself if you really know what they mean, and if you don't, ask for clarification. Instead of making assumptions, bring openness and curiosity to the interaction. You might be surprised at

what you discover.

4. **REFLECT** – Reflect back to them what you heard. This tells them that you were really listening.⁵¹

For this mindfulness activity, we want you to engage in mindful listening. Start by having a conversation with a friend, romantic partner, or family member. Before beginning the conversation, find a location that has minimal distractions, so try not to engage in this activity in a public space. Also, turn off the television and radio. The goal is to focus your attention on the other person. Start by employing the HEAR method for listening during your conversation. After you have finished this conversation, try to answer the following questions:

1. How easy was it for you to provide your conversational partner your full attention? When stray thoughts entered your head, how did you refocus yourself?
2. Were you able to pay attention to your breathing while engaged in this conversation? Were you breathing lightly or heavily? Did your breathing get in the way of you listening mindfully? If yes,

what happened?

3. Did you attempt to empathize with your conversational partner? How easy was it to understand where they were coming from? Was it still easy to empathize if you didn't agree with something they said or didn't like something they said?
4. How did your listening style impact your ability to stay mindful while listening? Do you think all four listening styles are suited for mindful listening? Why?

Key Takeaways

- Hearing happens when sound waves hit our eardrums. Listening involves processing these sounds into something meaningful.
- The listening process includes: having the motivation to listen, clearly hearing the message, paying attention, interpreting the message, evaluating the message, remembering and responding appropriately.
- There are many types of listening styles: comprehension, evaluative, empathetic, and appreciative.

Exercises

- Do a few listening activities. Go to: <http://www.medel.com/resources-for-success-soundscape/>
- For the next week, do a listening diary. Take notes of all the things you listen to and analyze to see if you are truly a good listener. Do you ask people to repeat things? Do you paraphrase?
- After completing the Listening Styles Questionnaire, think about your own listening style and how it impacts how you interact with others. What should you think about when communicating with people who have a different listening style?

7.4 Listening Responses

LEARNING OUTCOMES

1. Discuss different types of listening responses.
2. Discern different types of questioning.
3. Analyze perception checking.

Who do you think is a great listener? Why did you name that particular person? How can you tell that person is a good listener? You probably recognize a good listener based on the nonverbal and verbal cues that they display. In this section, we will discuss different types of listening responses. We all don't listen in the same way. Also, each situation is different and requires a distinct style that is appropriate for that situation.

Types of Listening Responses

Ronald Adler, Lawrence Rosenfeld, and Russell Proctor are three interpersonal scholars who have done quite a bit with listening.⁵² Based on their research, they have found different types of listening responses: silent listening, questioning, paraphrasing, empathizing, supporting, analyzing, evaluating, and advising (Figure 7.6).⁵³

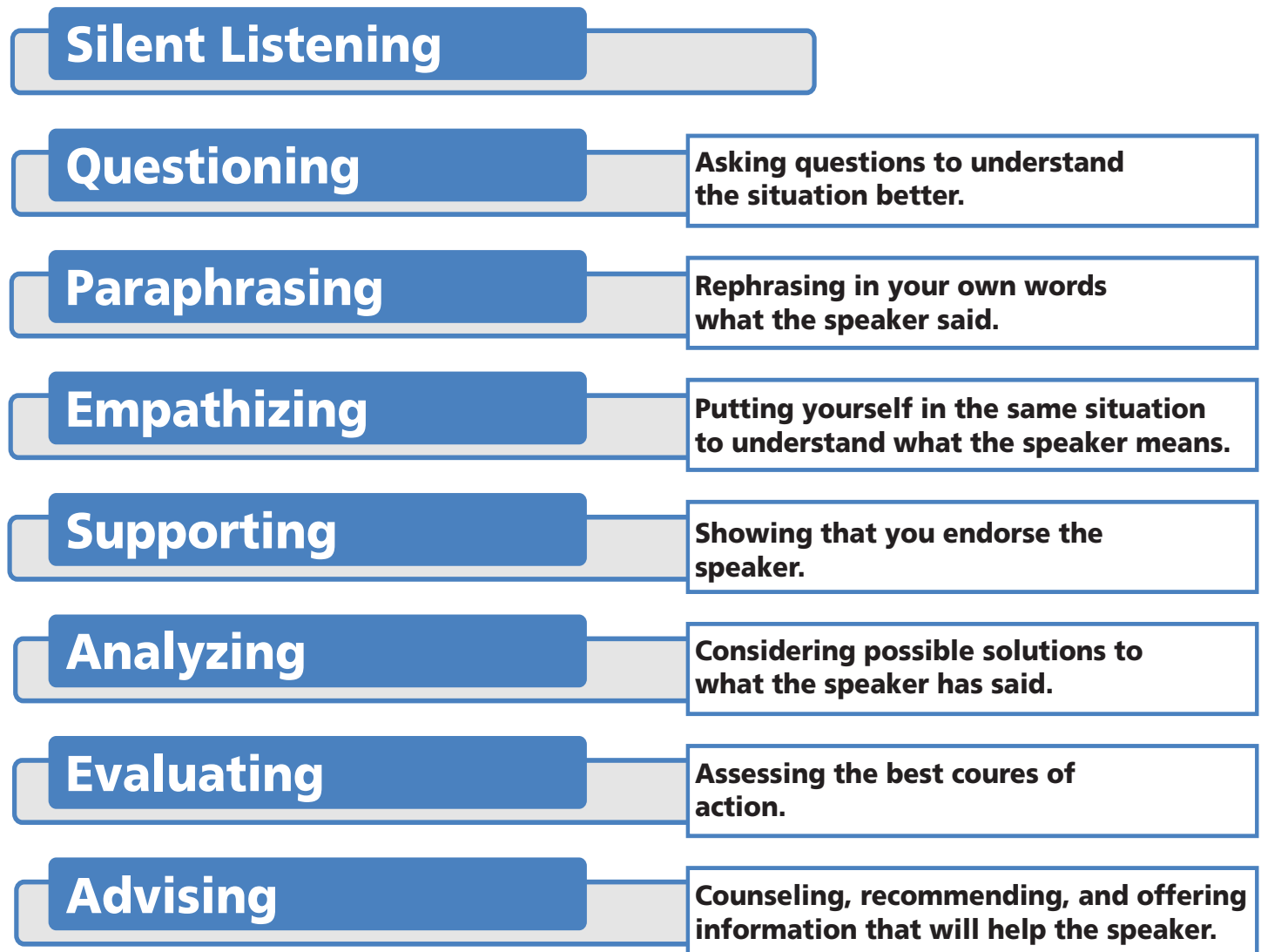

Figure 7.6. Types of Listening Responses

Silent Listening

Silent listening occurs when you say nothing. It is ideal in certain situations and awful in other situations. However, when used correctly, it can be very powerful. If misused, you could give the wrong impression to someone. It is appropriate to use when you don't want to encourage more talking. It also shows that you are open to the speaker's ideas.

Sometimes people get angry when someone doesn't respond. They might think that this person is not listening or trying to avoid the situation. But it might be due to the fact that the person is just trying to gather their thoughts, or perhaps it would be inappropriate to respond. There are certain situations such as in counseling, where silent listening can be beneficial because it can help that person figure out their feelings and emotions.

Questioning

In situations where you want to get answers, it might be beneficial to use questioning. You can do this in a variety of ways. There are several ways to **question** in a sincere, nondirective way (see Table 7.3):

Reason	Example
To clarify meanings	A young child might mumble something and you want to make sure you understand what they said.
To learn about others' thoughts, feelings, and wants (open/closed questions)	When you ask your partner where they see your relationship going in the next few years.
To encourage elaboration	Nathan says "That's interesting!" Jonna has to ask him further if he means interesting in a positive or negative way.
To encourage discovery	Ask your parents how they met because you never knew.
To gather more facts and details	Police officers at the scene of the crime will question any witnesses to get a better understanding of what happened.

Table 7.3 Types of Nondirective Questioning

You might have different types of questions. Sincere questions are ones that are created to find a genuine answer. Counterfeit questions are disguised attempts to send a message, not to receive one. Sometimes, counterfeit questions can cause the listener to be defensive. For instance, if someone asks you, "Tell me how often you used crystal meth." The speaker implies that you have used meth, even though that has not been established. A speaker can use questions that make statements by emphasizing specific words or phrases, stating an opinion or feeling on the subject. They can ask questions that carry hidden agendas, like "Do you have \$5?" because the person would like to borrow that money. Some questions seek "correct" answers. For instance, when a friend says, "Do I look fat?" You probably have a correct or ideal answer. There are questions that are based on unchecked assumptions. An example would be, "Why aren't you listening?" This example implies that the person wasn't listening, when in fact they are listening.

Paraphrasing

Paraphrasing is defined as restating in your own words, the message you think the speaker just sent. There are three types of paraphrasing. First, you can change the speaker's wording to indicate what you think they meant. Second, you can offer an example of what you think the speaker is talking about. Third, you can reflect on the underlying theme of a speaker's remarks. Paraphrasing represents mindful listening in the way that you are trying to analyze and understand the speaker's information. Paraphrasing can be used to summarize facts and to gain consensus in essential discussions. This could be used in a business meeting to make sure that all details were discussed and agreed upon. Paraphrasing can also be used to understand personal information more accurately. Think about being in a counselor's office. Counselors often paraphrase information to understand better exactly how you are feeling and to be able to analyze the information better.

Empathizing

Empathizing is used to show that you identify with a speaker's information. You are not empathizing when you deny others the rights to their feelings. Examples of this are statements such as, "It's really not a big deal" or "Who cares?" This indicates that the listener is trying to make the speaker feel a different way. In minimizing the significance of the situation, you are interpreting the situation in your perspective and passing judgment.

Supporting

Sometimes, in a discussion, people want to know how you feel about them instead of a reflection on the content. Several types of supportive responses are: agreement, offers to help, praise, reassurance, and diversion. The value of receiving support when faced with personal problems is very important. This has been shown to enhance psychological, physical, and relational health. To effectively support others, you must meet certain criteria. You have to make sure that your expression of support is sincere, be sure that other person can accept your support, and focus on "here and now" rather than "then and there."

Analyzing

Analyzing is helpful in gaining different alternatives and perspectives by offering an interpretation of the speaker's message. However, this can be problematic at times. Sometimes the speaker might not be able to understand your perspective or may become more confused by accepting it. To avoid this, steps must be taken in advance. These include tentatively offering your interpretation instead of as an absolute fact. By being more sensitive about it, it might be more comfortable for the speaker to accept. You can also make sure that your analysis has a reasonable chance of being correct. If it were inaccurate, it would leave the person more confused than before. Also, you must make sure the person will be receptive to your analysis and that your motive for offering is to truly help the other person. An analysis offered under any other circumstances is useless.

Evaluating

Evaluating appraises the speaker's thoughts or behaviors. The evaluation can be favorable ("That makes sense") or negative (passing judgment). Negative evaluations can be critical or non-critical (constructive criticism). Two conditions offer the best chance for evaluations to be received: if the person with the problem requested an evaluation, and if it is genuinely constructive and not designed as a putdown.

Advising

Advising differs from evaluations. It is not always the best solution and can sometimes be harmful. In order to avoid this, you must make sure four conditions are present: be sure the person is receptive to your suggestions, make sure they are truly ready to accept it, be confident in the correctness of your advice, and be sure the receiver won't blame you if it doesn't work out.

Perception Checking

Perceptions change in a relationship. Initially, people can view others positively (for example, confident,

thrifty, funny), then later in the relationship that person changes (arrogant, cheap, childish). The person hasn't changed. Only our perceptions of them have changed. That is why we focus on perception in a communication book because often, our perception affects how we communicate. It also has an impact on what we listen to and how we listen. For instance, when people get married, one person might say, "I love you! I would die for you," then a couple of years later, that same person might say, "I hate you! I am going to kill you!" Their perceptions about the other person will change.⁵⁴

Even when people break up, men typically will think about the physical aspects of the relationship (I gave her a watch, she wasn't that hot) and women will think about the emotional aspects of the relationship (I gave him my heart, I really cared about him.). Perception is an interesting thing because sometimes we think other people have a similar perspective, but as we will see, that is not always the case.

Selection

What we pay attention to varies from one person to another. The first step in the perception process is selection. It determines what things we focus on compared to what things we ignore. What we select to focus on depends on:

1. Intensity - if it is bigger, brighter, louder in some way. Think about all the advertisements that you view. If the words are bigger or if the sound is louder, you are more likely to pay attention to it. Advertisers know that intensity is very important to get people to pay attention.
2. Repetition-It has been said that to get someone to do something, they have to be told three different ways and three different times. People pay attention to things that repeat because you can remember it easier. In school, we learn to do things over and over again, because it teaches us mastery of a skill.
3. Differences - We will pay attention to differences, especially if it is a disparity or dissimilarity to what commonly occurs. Think about changes or adjustments that you had to deal with in life. These transformations made you notice the comparisons. For instance, children who go through a divorce will talk about the differences that they encountered. Children will focus on how things are different and how it is not the same.
4. Motives/Goals. We tend to pay attention to things for which have a strong interest or desire. If you love cars, you will probably notice cars more closely than someone else who has no interest in cars. Another example might be if you are single, then you might notice who is married and who is not more than someone in a committed relationship.
5. Emotions. Our emotional state has a strong impact on how we view life in general. If we are sad, we will probably notice other sad faces. The same thing happens when we are happy; we will tend to notice other happy people. Our emotions can impact how we feel. If we are angry, we might say things we don't mean and not perceive how we come across to other people.

Organization

The second phase in the perception process is organization, or how we arrange information in our minds. So, once we have selected what information we pay attention to, our minds try to process it. Sometimes when this occurs, we engage in stereotyping or attribute certain characteristics to a certain set of individuals. In other words, we classify or labels others based on certain qualities.

Also, when people organize information in their mind, they can also engage in punctuation, or establishing the effects and causes in communication behavior. It is more useful to realize that a conflict situation can be perceived differently by each person, and it is important to focus on "What we can do to

make this situation better?”

Interpretation

The third phase of the perception process is interpretation. In this phase, we try to understand the information or make sense of it. This depends on a few factors:

1. Degree of involvement—If we were in the middle of an accident, we would probably have more information regarding what event occurred compared to a bystander. The more involved we are with something, the more we can make sense of what is actually happening. For instance, in cults, the members understand the rules and rituals, but an outsider would not understand, because they are not exposed to the rules and rituals.
2. Relational satisfaction – If we are happy in a relationship, we tend to think that everything is wonderful. However, if you are dissatisfied in the relationship, you might second guess the behaviors and actions of your partner.
3. Past experiences – If you had a good past experience with a certain company, you might think that everything they do is wonderful. However, if your first experience was horrible, you may think that they are always horrible. In turn, you will interpret that company’s actions as justified because you already encountered a horrible experience.
4. Assumptions about human behavior – If you believed that most people do not lie, then you would probably be very hurt if someone important to you lied to you. Our assumptions about others help us understand their behaviors and actions. If you had a significant other cheats on you, you would probably be suspicious of future interactions with other significant others.
5. Expectations – Our behaviors are also influenced by our expectations of others. If we expect a party to be fun and it isn’t, then we will be let down. However, if we have no expectations about a party, it may not affect how we feel about it.
6. Knowledge of others – If you know that someone close to you has a health problem, then it will not be a shock if they need medical attention. However, if you had no clue that this person was unhealthy, it would come as a complete surprise. How you interpret a given situation is oftentimes based on what you know about a certain situation.⁵⁵

Negotiation

The last phase of the perception process is called negotiation. In this phase, people are trying to understand what is happening. People often use narratives or stories to explain and depict their life. For instance, a disagreement between a teacher and student might look very different depending on which perspective you take. The student might perceive that they are hard-working and very studious. The student thinks they deserve a high grade. However, the teacher might feel that their job is to challenge all students to their highest levels and be fair to all students. By listening to both sides, we can better understand what is going on and what needs to be done in certain situations. Think about car accidents and how police officers have to listen to both sides. Police officers have to determine what happened and who is at fault. Sometimes it is not an easy task.

Influences on Perception

All of us don’t perceive the same things. One person might find something beautiful, but another person might think it is horrible. When it comes to our perception, there are four primary influences we should

understand: physiological, psychological, social, and cultural.

Physiological Influences

Some of the reasons why we don't interpret things, in the same way are due to physiology. Hence, biology has an impact on what we do and do not perceive. In this section, we will discuss the various physiological influences.

1. Senses - Our senses can have an impact on what and where we focus our attention. For instance, if you have a strong sense of smell, you might be more sensitive to a foul-smelling odor compared to someone who cannot smell anything due to sinus problems. Our senses give us a different perception of the world.
2. Age - Age can impact what we perceive. Have you ever noticed that children have so much energy, and the elderly do not? Children may perceive that there is so much to do in a day, and the elderly may perceive that there is nothing to do. Our age influences how we think about things.
3. Health - when we are healthy, we have the stamina and endurance to do many things. However, when we are sick, our bodies may be more inclined to rest. Thus, we will perceive a lot of information differently. For instance, when you are healthy, some of your favorite meals will taste really good, but when you are sick, it might not taste so good, because you cannot smell things due to a stuffy nose.
4. Hunger - When you are hungry, it is tough to concentrate on anything except food. Studies have shown that when people are hungry, all they focus on is something to eat.
5. Biological cycles - Some people are "morning larks" and some are "night owls." In other words, there are peaks where people perform at their highest level. For some individuals, it is late at night, and for others, it is early in the morning. When people perform at their peak times, they are likely to be more perceptive of information. If you are a person who loves getting up early, you would probably hate night classes, because you are not able to absorb as much information as you could if the class was in the morning.

Psychological Influences

Sometimes the influences on perception are not physiological but psychological. These influences include mood and self-concept. These influences are based in our mind, and we can't detect them in others.

1. Mood - Whether we are happy or sad can affect how we view the world. For instance, if we are happy, then anything that happens, we might view it more positively.
2. Self-concept - If we have a healthy self-concept of ourselves, we may not be offended if someone makes a negative remark. Yet, if we have a poor self-concept of ourselves, then we are probably going to be more influenced by negative remarks. The stronger our self-concept is, the more likely it will affect how we view perceive other people's communication behaviors toward us.

Social Influences

Social influences include sex and gender roles, as well as occupational roles. These roles can impact our perceptions. Because we are in these roles, we might be likely to think differently than others in different roles.

1. Sex and gender roles - We have certain expectations in our culture regarding how men and

women should behave in public. Women are expected to be more nurturing than men. Moreover, men and women are viewed differently concerning their marital status and age.

2. Occupational roles – Our jobs have an influence on how we perceive the world. If you were a lawyer, you might be more inclined to take action on civil cases than your average member of the public, because you know how to handle these kinds of situations. Moreover, if you are a nurse or medical specialist, you are more likely to perceive the health of other individuals. You would be able to tell if someone needed urgent medical care or not.

Research Spotlight



In 2015, Karina J. Lloyd, Diana Boer, Avraham N. Kluger, and Sven C. Voelpel conducted an experiment to examine the relationship between perceived listening trust and wellbeing. In this study, the researchers recruited pairs of strangers. They had one of the participants tell the other about a positive experience in their life for seven minutes (the talker) and one who sat and listened to the story without comment (the listener).

The researchers found that talkers who perceived the listener to be listening intently to be very important for effective communication. First, perceived listening led to a greater sense of social attraction towards the listener, which in turn, led to a greater sense of trust for the listener. Second, talkers who perceived the listener as listening intently felt their messages were clearer, which in turn, led to a greater sense of the talker's overall wellbeing (positive affect).

As you can see, simply perceiving that the other person is listening intently to you is very important on a number of fronts. For this reason, it's very important to remember to focus your attention when you're listening to someone.

Lloyd, K. J., Boer, D., Kluger, A. N., & Voelpel, S. C. (2015). Building trust and feeling well: Examining intraindividual and interpersonal outcomes and underlying mechanisms of listening. *International Journal of Listening*, 29(1), 12-29. <https://doi.org/10.1080/10904018.2014.928211>

Cultural Influences

In a recent meeting, the boss said, "Remember the Golden Rule," and a coworker from India asked the staff about the meaning of that phrase. He wondered if there was a silver rule or a bronze rule. The reason he didn't understand this concept is due to cultural influences. We know that everyone doesn't perceive things in the same fashion.

In some countries, the elderly are highly respected individuals, where the youth go to for advice and wisdom. Yet, in other countries, the elderly are seen as lazy and worthless. Hence, our culture has an impact on how we perceive the world and others. Communication is different across cultures. Western cultures, like the United States, value talk and view it as very important to function and conduct business. Thus, they do not like silence because it can be perceived as shyness, frustration, and intimidating.⁵⁶ Western culture dislikes silence because it is uncomfortable and problematic. Asian cultures have different perceptions of communication. Silence is seen as valuable to reflect on one's thinking. Asians might view someone who is talkative very negatively. Based on this example, we can see that cultural perceptions can lead to problems, because, to an American, silence is considered rude and to an Asian, silence is good. To effectively communicate, we need to understand cultural perceptions.

Perception Checking

To judge others more accurately, we need to engage in perception checking.

Perception checking involves three steps:

1. Describe your perception of the event
2. Offer three different interpretations of that behavior
3. Seek clarification about the interpretations
4. That's it! I know this sounds easy, but it's definitely much harder than it looks.

Key Takeaways

- The different types of listening responses are silent listening, questioning, paraphrasing, empathizing, supporting, analyzing, evaluating, and advising.
- Questioning can be to clarify meanings, encourage elaboration, learn about others, increase discovery, or obtain more information.
- Perception checking involves describing the situation, offering three possible interpretations, and then seeking information.

Exercises

- Write down an example of each of the listening responses and why it is appropriate for that situation. Why did you write down what you did?
- Create a chart with the different types of questions and give at least two examples for each type. Compare with a friend in class.
- Watch a movie or television show with your friends, then ask them to write down the three most notable moments. Compare what you wrote to others. Was it similar or different? Why or why not? Did you all have the same perceptions? Why?

Chapter Wrap-Up

We spend most of our lives engaged in talking and listening behavior. As such, understanding the functions of talking and listening in interpersonal communication is very important. In this chapter, we started by discussing the importance of everyday conversations. We next discussed a specific type of talk: disclosing information about ourselves (self-disclosure). We then switched gears and focused on the listening component. Overall, talking and listening are extremely important to interpersonal communication, so understanding how they function can help improve our communication skills.

End of Chapter

KEY TERMS

- Analyzing
- Appreciative Listening
- Communication Motives
- Communication Needs
- Comprehension Listening
- Conversations
- Emotional Blackmail
- Empathic Listening
- Empathizing
- Evaluative Listening
- Hearing
- Johari Window
- Listening
- Paraphrase
- Self-Disclosure
- Silent Listening
- Social Penetration Theory

REAL WORLD CASE STUDY

Microtela is the new leader in telecommunications. However, many customers are having problems with their new cell phones. They have tried calling customer service to solve their problems. However, many of the customers get frustrated and wind up terminating their cell phone contracts. Microtela does some research and discovers that many of their customer service representatives do not know how to listen effectively. Many of the customers who call the company have complained that no one is listening to their problems.

1. If you were hired as a consultant for this business, how would you fix this problem?
2. How can you teach customer service representatives better listening skills?
3. What are some strategies to help customers feel like they are being listened to?

END OF CHAPTER QUIZ

1. Kara couldn't wait to talk to her best friend Jose. She's had a truly horrible, no good, very bad day. As soon as Jose enters her apartment, she just starts venting. What type of conversation is Kara having with Jose?
 - a. discourse
 - b. debate
 - c. dialogue
 - d. deviant
 - e. diatribe
2. Cory doesn't know if he is a good cook because he has never been in a kitchen. His friends don't even know if Cory has a kitchen in his house. Which window pane of Johari's window does this represent?
 - a. open
 - b. blind

- c. hidden
- d. unknown
- e. closed

3. All of the following are types of listening except:

- a. silent listening
- b. questioning
- c. empathizing
- d. imagining
- e. advising

4. In this chapter, we discuss all of the following types of listening except:

- a. comprehension
- b. evaluative
- c. empathetic
- d. appreciative
- e. interpretive

5. Meno's girlfriend has been seen with other male friends. His friends try and tell him that she is cheating on him, but he refuses to believe what they say. Even when they have pictures and proof, he doesn't listen to their words. He is displaying:

- a. interrupting
- b. daydreaming
- c. pseudo-listening
- d. emotional listening
- e. insulated listening

References

- 1 Apps, J. (2014). *The art of conversation: Change your life with confident communication*. Capstone; pg. 12.
- 2 Miller, S. (2006). *Conversation: A history of a declining art*. Yale University Press.
- 3 Allen, D. E., & Guy, R. F. (1974). *Conversation analysis: The sociology of talk*. Mouton; pg. 11.
- 4 Brennan, S. E. (2013). Conversation and dialogue. In H. Pashler (Ed.). *Encyclopedia of the mind* (pp. 202-205). Sage; pg. 202.
- 5 Turkle, S. (2012, April). Alone together. Ted Talks, ¶ 8. https://www.ted.com/talks/sherry_turkle_alone_together/transcript
- 6 Ibid.
- 7 Duck, S. (2007). *Understanding Relationships*. Guilford, Press.
- 8 Angle, D. W. (2016, December 28). The four types of conversations: Debate, dialogue, discourse, and diatribe. *The Opportune Conflict*. <https://tinyurl.com/yd9x3xfr>
- 9 Ibid., para. 5
- 10 Ibid., para. 7
- 11 Berger, C.R. & Calabrese, R.J. (1975). Some explorations in initial interaction and beyond: Toward a developmental theory of interpersonal communication. *Human Communication Research*, 1, 99-112.
- 12 Sprecher, S., Treger, S., Wondra, J. D., Hilaire, N., & Wallpe, K. (2013). Taking turns: Reciprocal self-disclosure promotes liking in initial interactions. *Journal of Experimental Social Psychology*, 49(5), 860–866. <https://doi.org/10.1016/j.jesp.2013.03.017>
- 13 Jourard, S. (1971). *The transparent self*. Van Nostrand.
- 14 Ignatius, E., & Kokkonen, M. (2007). Factors contributing to verbal self-disclosure. *Nordic Psychology*, 59(4), 362–391. <https://doi.org/10.1027/1901-2276.59.4.362>
- 15 Ibid.
- 16 Collins, N. L., & Miller, L. C. (1994). Self-disclosure and liking: A meta-analytic review. *Psychological Bulletin*, 116(3), 457–475. <https://doi.org/10.1037/0033-2909.116.3.457>
- 17 Burgoon, J. K., & Jones, S. B. (1976). Toward a theory of personal space expectations and their violations. *Human Communication Research*, 2(2), 131-146. <https://doi.org/10.1111/j.1468-2958.1976.tb00706.x>
- 18 Burgoon, J. K., & Hale, J. L. (1988). Nonverbal expectancy violations: Model elaboration and application to immediacy behaviors. *Communication Monographs*, 55(1), 58-79. <https://doi.org/10.1080/03637758809376158>
- 19 Bachman, G. F., & Guerrero, L. K. (2006). Relational quality and communicative responses following hurtful events in dating relationships: An expectancy violations analysis. *Journal of Social and Personal Relationships*, 23(6), 943–963. <https://doi.org/10.1177/0265407506070476>
- 20 Frisby, B. N., & Sidelinger, R. K. (2013). Violating student expectations: Student disclosures and student reactions in the college classroom. *Communication Studies*, 64(3), 241-258. <https://doi.org/10.1080/10510974.2012.755636>
- 21 Giles, H., Coupland, N., & Coupland, J. (1991). Accommodation theory: Communication context and consequence. In H. Giles, J. Coupland & N. Coupland (Eds.), *Contexts of accommodation: Developments in applied sociolinguistics* (pp. 1-68). Cambridge University Press.
- 22 Ignatius, E., & Kokkonen, M. (2007). Factors contributing to verbal self-disclosure. *Nordic Psychology*, 59(4), 362–391. <https://doi.org/10.1027/1901-2276.59.4.362>; pg. 367.
- 23 Gardner, W. L., & Martinko, M. J. (1988). Impression management: An observational study linking audience characteristics with verbal self-presentations. *Academy of Management Journal*, 31(1), 42–65. <https://doi.org/10.2307/256497>
- 24 Schlenker, B. R. (1980). *Impression management: The self-concept, social identity and interpersonal relations*. Brooks Cole.
- 25 Ignatius, E., & Kokkonen, M. (2007). Factors contributing to verbal self-disclosure. *Nordic Psychology*,

59(4), 362–391. <https://doi.org/10.1027/1901-2276.59.4.362>

26 Schlenker, B. R. (1980). *Impression management: The self-concept, social identity and interpersonal relations*. Brooks Cole; pg. 136.

27 Gardner, W. L., & Martinko, M. J. (1988). Impression management: An observational study linking audience characteristics with verbal self-presentations. *Academy of Management Journal*, 31(1), 42–65. <https://doi.org/10.2307/256497>; pg. 43.

28 Schlenker, B. R. (1980). *Impression management: The self-concept, social identity and interpersonal relations*. Brooks Cole; pg. 154.

29 Ibid.; pg. 163.

30 Gardner, W. L., & Martinko, M. J. (1988). Impression management: An observational study linking audience characteristics with verbal self-presentations. *Academy of Management Journal*, 31(1), 42–65. <https://doi.org/10.2307/256497>; pg. 44.

31 Ibid.; pg. 44.

32 Altman, I., & Taylor, D. A. (1973). *Social Penetration: the development of interpersonal relationships*. Holt, Rinehard, & Winston, Inc.

33 Duck, S. W. (2006). The play, playfulness, and the players: Everyday interaction as improvised rehearsal of relationships. *Composing relationships: Communication in everyday life*. Wadsworth, pgs. 15-23.

34 Griffin, E. (2012). *A first look at communication theory* (8th ed.) McGraw Hill.

35 Luft, J., & Ingham, H. (1955). The Johari window, a graphic model of interpersonal awareness. In *Proceedings of the Western Training Laboratory in Group Development*. University of California-Los Angeles..

36 Hayes, J. (1991). *Interpersonal skills: Goal-directed behaviour at work*. Routledge.

37 Wrench, J. S., Goding, A., Johnson, D. I., & Attias, B. A. (2017). *Stand up, speak out: The practice and ethics of public speaking* (version 2.0). Flat World Knowledge, pg. 50.

38 Ibid.; pg. 61.

39 Brownell, J. (1985). A model for listening instruction: Management applications. *The Bulletin of the Association for Business Communication*, 48(3), 39-44. <https://doi.org/10.1177/108056998504800312>

40 Ibid., pg. 43.

41 Siegel, D. J. (2007). Mindfulness training and neural integration: Differentiation of distinct streams of awareness and the cultivation of well-being. *Social Cognitive and Affective Neuroscience*, 2(4), 259–263. <https://dx.doi.org/10.1093/scan/nsm034>

42 Wolvin, A. D., & Coakley, C.G. (1979). *Listening instruction*. ERIC.

43 Wolvin, A. D. (2010). Listening engagement: Intersecting theoretical perspectives. In A. D. Wolvin (Ed.), *Listening and human communication in the 21st Century* (pp. 7-30). Wiley-Blackwell; pg. 20.

44 Watson, K. W., Barker, L. L., & Weaver, J. B., III. (1995). The listening styles profile (LSP-16): Development and validation of an instrument to assess four listening styles. *International Journal of Listening*, 9, 1–13; pg. 2.

45 Watson, K. W., Barker, L. L., & Weaver, J. B., III. (1992, March). *Development and validation of the Listener Preference Profile*. Paper presented at the International Listening Association in Seattle, WA.

46 Bodie, G., & Worthington, D. (2010). Revisiting the Listening Styles Profile (LSP-16): A confirmatory factor analytic approach to scale validation and reliability estimation. *International Journal of Listening*, 24(2), 69–88. <https://doi.org/10.1080/10904011003744516>; pg. 71.

47 Ibid.; pg. 71.

48 Grant, K. (n.d.). *Being aware of listening styles used in communication reduces your stress levels*. <https://www.kingsleygrant.com/knowning-listening-styles-reduces-stress/>

49 Bodie, G. D., Worthington, D. L., & Gearhart, C. C. (2013). The Listening Styles Profile-Revised (LSP-R): A scale revision and evidence for validity. *Communication Quarterly*, 61(1), 72–90. <https://doi.org/10.1080/01463373.2012.720343>; pg. 73.

50 Mallard, K. S. (1999). Lending an ear: The chair's role as listener. *The Department Chair*, 9(3), 1-13.

51 Smookler, E. (2017, March 15). How to practice mindful listening: Giving someone your full attention in

conversation isn't easy, but it is a skill we can practice and hone. *Mindful*. <https://www.mindful.org/how-to-practice-mindful-listening/>; para. 8.

52 Adler, R., Rosenfeld, L. B., & Proctor II, R. F. (2013). *Interplay: The process of Interpersonal Communication*. Oxford.

53 Ibid.

54 Ibid.

55 Ibid.

56 Giles, H., Coupland, N., & Weimann, J. M. (1992). "Talk is cheap..." but "my word is my bond": Beliefs about talk. In K. Bolton & H. Kwok (Eds.), *Sociolinguistics today: International perspectives* (pp. 218-243). Routledge & Kegan Paul.

END OF CHAPTER QUIZ

ANSWER KEY

1) E 2) D 3) D 4) E 5) B





Image by ID 1715736 from Pixabay

Chapter 8

Building and Maintaining Relationships

Over the course of our lives, we will enter into and out of many different relationships. When it comes to dating, the average person has seven relationships before getting married.¹ According to a study conducted by OnePoll in conjunction with Evite, the average American has:

- Three best friends
- Five good friends
- Eight people they like but don't spend one-on-one time with
- 50 acquaintances
- 91 social media friends²

In this chapter, we are going to discuss how we go about building and maintaining our interpersonal relationships.

8.1 The Nature of Relationships

LEARNING

OUTCOMES

1. Understand relationship characteristics.
2. Identify the purposes of relationships.
3. Explain the elements of a good relationship.

We've all been in a wide range of relationships in our lives. This section is going to explore relationships by examining specific relationship characteristics and the nature of significant relationships.

Relationship Characteristics

We all know that all relationships are not the same. We have people in our lives that we enjoy spending time with, like to support us, and/or assist us when needed. We will typically distance ourselves from people who do not provide positive feelings or outcomes for us. Thus, there are many characteristics in relationships that we have with others. These characteristics are: duration, contact frequency, sharing, support, interaction variability, and goals.³

Some friendships last a lifetime, others last a short period. The length of any relationship is referred to as that relationship's **duration**. People who grew up in small towns might have had the same classmate till graduation. This is due to the fact that duration with each person is different. Some people we meet in college and we will never see them again. Hence, our duration with that person is short. **Duration** is related to the length of your relationship with that person.

Second, **contact frequency** is how often you communicate with the other person. There are people in our lives we have known for years but only talk to infrequently. The more we communicate with others, the closer our bond becomes to the other person. Sometimes people think duration is the real test of a relationship, but it also depends on how often you communicate with the other person.

The third relationship trait is **sharing**. The more we spend time with other people and interact with them, the more we are likely to share information about ourselves. This type of sharing involves information that is usually our private and very intimate details of our thoughts and feelings. We typically don't share this information with a stranger. Once we develop a sense of trust and support with this person, we can begin to share more details.

The fourth characteristic is **support**. Think of the people in your life and who you would be able to call in case of an emergency. The ones that come to mind are the ones you know who would be supportive of you. They would support you if you needed help, money, time, or advice. Support is another relationship trait because we know that not everyone can support us in the same manner. For instance, if you need relationship advice, you would probably pick someone who has relationship knowledge and would support you in your decision. Support is so important. A major difference found between married and dating couples is that married couples were more likely to provide supportive communication behaviors to their partners than dating couples.⁴

The fifth defining characteristic of relationships is the **interaction variability**. When we have a relationship with another person, it is not defined by your interaction with them, rather on the different types of conversations you can have with that person. When you were little, you probably knew that if

you were to approach your mom, she might respond a certain way as opposed to your dad, who might respond differently. Hence, you knew that your interaction would vary. The same thing happens with your classmates because you don't just talk about class with them. You might talk about other events on campus or social events. Therefore, our interactions with others are defined by the greater variability that we have with one person as opposed to another.

The last relationship characteristic is **goals**. In every relationship we enter into, we have certain expectations about that relationship. For instance, if your goal is to get closer to another person through communication, you might share your thoughts and feelings and expect the other person to do the same. If they do not, then you will probably feel like the goals in your relationship were not met because they didn't share information. The same goes for other types of relationships. We typically expect that our significant other will be truthful, supportive, and faithful. If they break that goal, then it causes problems in the relationship and could end the relationship. Hence, in all our relationships, we have goals and expectations about how the relationship will function and operate.

Significant Relationships

Think about all the relationships that you have in your life. Which ones are the most meaningful and significant for you? Why do you consider these relationships as the most notable one(s) for you? Your parents/guardians, teachers, friends, family members, and love interests can all serve as significant relationships for you. Significant relationships have a huge impact on our communication behaviors and our interpretation of these conversations. Significant relationships impact who we are and help us grow. These relationships can serve a variety of purposes in our lives.

Purposes of Relationships

Relationships can serve a variety of purposes: work, task, and social. First, relationships can be work-related. We might have a significant work relationship that helps us advance our professional career. We might have work relationships that might support us in gaining financial benefits or better work opportunities. Second, we might have significant relationships that are task-related. We may have a specific task that we need to accomplish with this other person. It might be a project or a mentorship. After the task is completed, then the relationship may end. For instance, a high school coach may serve as a significant relationship. You and your coach might have a task or plan to go to the state competition. You and your coach will work on ways to help you. However, after you complete high school and your task has ended, then you might keep in contact with the coach, or you may not since your competition (task) has ended. The last purpose is for social reasons. We may have social reasons for pursuing a relationship. These can include pleasure, inclusion, control, and/or affection. Each relationship that we have with another person has a specific purpose. We may like to spend time with a particular friend because we love talking to them; at the same time, we might like spending time with another friend because we know that they can help us become more involved with extracurricular activities.

Elements of a Good Relationship

In summary, relationships are meaningful and beneficial. Relationships allow us to grow psychologically, emotionally, and physically. We can connect with others and truly communicate. The satisfaction of our relationships usually determines our happiness and health.

Key Takeaways

- The nature of a relationship is not determined immediately; often, it evolves and is defined and redefined over time.
- Relationship characteristics include duration, contact frequency, sharing, support, interaction variability, and goals. The purposes of a relationship are for security and health.
- Elements of a good relationship include trust, commitment, willingness to work together to maintain the relationship, support, intimacy, empathy, and skills for dealing with emotions.

Exercises

- Conduct an inventory of your relationships. Think of all the people in your life and how they meet each of the relationship characteristics.
- Write a list of all the good relationships that you have with others or witnessed. What makes these relationships good? Is it similar to what we talked about in this chapter? Was anything different? Why?
- Write a hypothetical relationship article for a website. What elements make a lasting relationship? What would you write? What would you emphasize? Why? Let a friend read it and provide input.

8.2 Relationship Formation

LEARNING OUTCOMES

1. Understand attraction.
2. Ascertain reasons for attraction.
3. Realize the different types of attraction.

Have you ever wondered why people pick certain relationships over others? We can't pick our family members, although I know some people wish they could. We can, however, select who our friends and significant others are in our lives. Throughout our lives, we pick and select people that we build a connection to and have an attraction towards. We tend to avoid certain people who we don't find attractive.

Understanding Attraction

Researchers have identified three primary types of attraction: physical, social, and task. **Physical attraction** refers to the degree to which you find another person aesthetically pleasing. What is deemed aesthetically pleasing can alter greatly from one culture to the next. We also know that pop culture can greatly define what is considered to be physically appealing from one era to the next. Think of the

curvaceous ideal of Marilyn Monroe and Elizabeth Taylor in the 1950s as compared to the thin Halle Barry or Anne Hathaway. Although discussions of male physical attraction occur less often, they are equally impacted by pop culture. In the 1950s, you had solid men like Robert Mitchum and Marlon Brando as compared to the heavily muscled men of today like Joe Manganiello or Zac Efron.

The second type of attraction is **social attraction**, or the degree to which an individual sees another person as entertaining, intriguing, and fun to be around. We all have finite sources when it comes to the amount of time we have in a given day. We prefer to socialize with people that we think are fun. These people may entertain us or they may just fascinate us. No matter the reason, we find some people more socially desirable than others. Social attraction can also be a factor of power, for example, in situations where there are kids in the “in-group” and those that are not. In this case, those that are considered popular hold more power and are perceived as being more socially desirable to associate with. This relationship becomes problematic when these individuals decide to use this social desirability as a tool or weapon against others.

The final type of attraction is **task attraction**, or people we are attracted to because they possess specific knowledge and/or skills that help us accomplish specific goals. The first part of this definition requires that the target of task attraction possess specific knowledge and/or skills. Maybe you have a friend who is good with computers who will always fix your computer when something goes wrong. Maybe you have a friend who is good in math and can tutor you. Of course, the purpose of these relationships is to help you accomplish your own goals. In the first case, you have the goal of not having a broken down computer. In the second case, you have the goal of passing math. This is not to say that an individual may only be viewed as task attractive, but many relationships we form are because of task attraction in our lives.

Reasons for Attraction

Now that we’ve looked at the basics of what attraction is, let’s switch gears and talk about why we are attracted to each other. There are several reasons researchers have found for our attraction to others, including proximity, physicality, perceived gain, similarities and differences, and disclosure.

Physical Proximity

When you ask some people how they met their significant other, you will often hear proximity is a factor in how they met. Perhaps, they were taking the same class or their families went to the same grocery store. These common places create opportunities for others to meet and mingle. We are more likely to talk to people that we see frequently.

Physical Attractiveness

In day-to-day interactions, you are more likely to pay attention to someone you find more attractive than others. Research shows that males place more emphasis on physical attractiveness than females.⁵ Appearance is very important at the beginning of the relationship.

Perceived Gain

This type of relationship might appear to be like an economic model and can be explained by **exchange theory**.⁶ In other words, we will form relationships with people who can offer us rewards that outweigh

the costs. Rewards are the things we want to acquire. They could be tangible (e.g., food, money, clothes) or intangible (support, admiration, status). Costs are undesirable things that we don't want to expend a lot of energy to do. For instance, we don't want to have to constantly nag the other person to call us or spend a lot of time arguing about past items. A good relationship will have fewer costs and more rewards. A bad relationship will have more costs and fewer rewards. Often, when people decide to stay or leave a relationship, they will consider the costs and rewards in the relationship.

Costs and rewards are not the only factors in a relationship. Partners also consider alternatives in the relationship. For instance, Becky and Alan have been together for a few years. Becky adores Alan and wants to marry him, but she feels that there are some problems in the relationship. Alan has a horrible temper; he is pessimistic; and he is critical of her. Becky has gained some weight, and Alan has said some hurtful things to her. Becky knows that every relationship will have issues. She doesn't know whether to continue this relationship and take it further or if she should end it.

Her first alternative is called the **comparison level (CL)**, which is the minimum standard that she is willing to tolerate. If Becky believes that it is ok for a person to say hurtful things to her or get angry, then Alan is meeting or exceeding her CL. However, if past romantic partners have never said anything hurtful towards her, then she would have a lower CL.

Becky will also consider another alternative, which is the **comparison level of alternatives (CL_{alt})**, or the comparison between current relationship rewards and what she might get in another relationship. If she doesn't want to be single, then she might have a lower CL of alternatives. If she has another potential mate who would probably treat her better, then she would have a higher level of alternatives. We use this calculation all the time in relationships. Often when people are considering the possibility to end a relationship, they will consider all alternatives rather than just focusing on costs and rewards.

Similarities and Differences

It feels comforting when someone who appears to like the same things you like also has other similarities to you. Thus, you don't have to explain yourself or give reasons for doing things a certain way. People with similar cultural, ethnic, or religious backgrounds are typically drawn to each other for this reason. It is also known as **similarity thesis**. The similarity thesis basically states that we are attracted to and tend to form relationships with others who are similar to us.⁷ There are three reasons why similarity thesis works: validation, predictability, and affiliation. First, it is validating to know that someone likes the same things that we do. It confirms and endorses what we believe. In turn, it increases support and affection. Second, when we are similar to another person, we can make predictions about what they will like and not like. We can make better estimations and expectations about what the person will do and how they will behave. The third reason is due to the fact that we like others that are similar to us and thus they should like us because we are the same. Hence, it creates affiliation or connection with that other person.

However, there are some people who are attracted to someone completely opposite from who they are. This is where differences come into play. Differences can make a relationship stronger, especially when you have a relationship that is **complementary**. In complementary relationships, each person in the relationship can help satisfy the other person's needs. For instance, one person likes to talk, and the other person likes to listen. They get along great because they can be comfortable in their communication behaviors and roles. In addition, they don't have to argue over who will need to talk. Another example might be that one person likes to cook, and the other person likes to eat. This is a great relationship because both people are getting what they like, and it complements each other's talents. Usually, friction will occur when there are differences of opinion or control issues. For example, if you have someone who loves to spend money and the other person who loves to save money, it might be very hard to decide

how to handle financial issues.

Disclosure

Sometimes we form relationships with others after we have disclosed something about ourselves to others. Disclosure increases liking because it creates support and trust between you and this other person. We typically don't disclose our most intimate thoughts to a stranger. We do this behavior with people we are close to because it creates a bond with the other person.

Disclosure is not the only factor that can lead to forming relationships. Disclosure needs to be appropriate and reciprocal⁸. In other words, if you provide information, it must be mutual. If you reveal too much or too little, it might be regarded as inappropriate and can create tension. Also, if you disclose information too soon or too quickly in the relationship, it can create some negative outcomes.

Key Takeaways

- We can be attracted to another person via various ways. It might be due to physical proximity, physical appearance, perceived gain, similarity/differences, and disclosure.
- The deepening of relationships can occur through disclosure and mutual trust.
- Relationships end through some form of separation or dissolution.

Exercises

- Take a poll of the couples that you know and how they met. Which category does it fall into? Is there a difference among your couples and how they met?
- What are some ways that you could form a relationship with others? Discuss your findings with the class. How is it different/similar to what we talked about in this chapter?
- Discuss how and why a certain relationship that you know dissolved. What were the reasons or factors that caused the separation?

8.3 Stages of Relationships

LEARNING OUTCOMES

1. Describe the coming together stages.
2. Discern the coming apart stages.
3. Realize relationship maintenance strategies.

Every relationship goes through various stages. Mark Knapp first introduced a series of stages through which relationships can progress.⁹ This model was later modified by himself and coauthor Anita Vangelisti to create a model of relationships.¹⁰ They believe that we come together and we can come

Coming Together

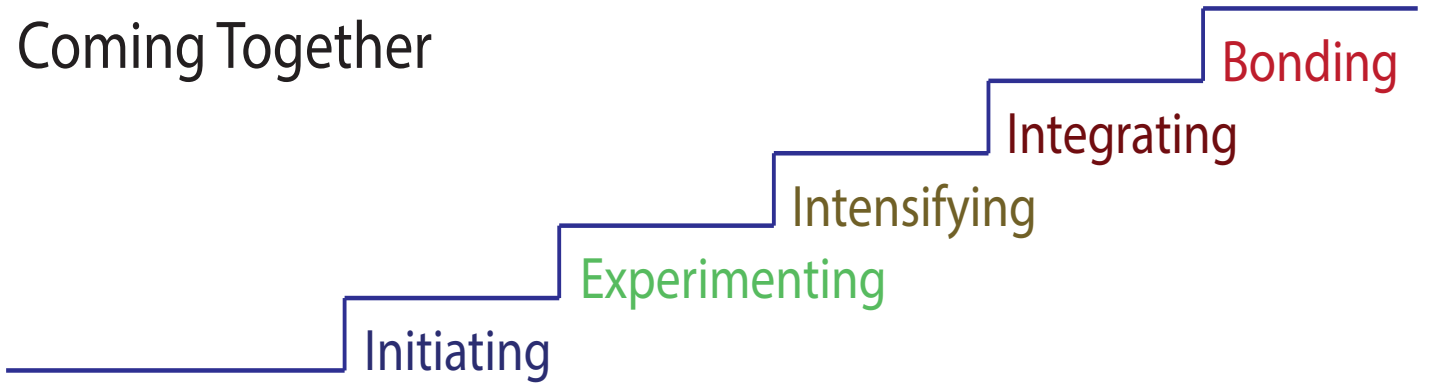

Coming Apart

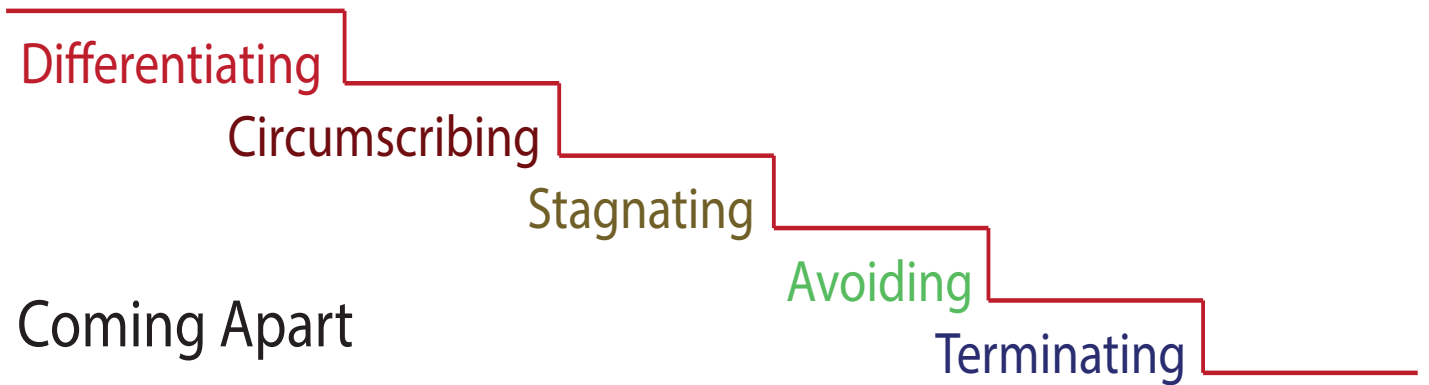

Figure 8.1 Knapp and Vangelisti Model of Relationships

apart in stages. Relationships can get stronger or weaker. Most relationships go through some or all of these stages.

Coming Together

Do you remember when you first met that special someone in your life? How did your relationship start? How did you two become closer? Every relationship has to start somewhere. It begins and grows. In this section, we will learn about the coming together stages, which include: initiating, experimenting, intensifying, integrating, and then bonding.

Initiating

At the beginning of every relationship, we have to figure out if we want to put in the energy and effort to talk to the other person. If we are interested in pursuing the relationship, we have to let the other person know that we are interested in initiating a conversation.

There are different types of initiation. Sustaining is trying to continue the conversation. Networking is where you contact others for a relationship. An offering is where you present your interest in some manner. Approaching is where you directly make contact with the other person. We can begin a relationship in a variety of different ways.

Communication at this **initiating** stage is very brief. We might say hello and introduce yourself to the other person. You might smile or wink to let the other person know you are interested in making conversation with him or her. The conversation is very superficial and not very personal at all. At this

stage, we are primarily interested in making contact.

Experimenting

After we have initiated communication with the other person, we go to the next stage, which is **experimenting**. At this stage, you are trying to figure out if you want to continue the relationship further. We are trying to learn more about the other person.

At this stage, interactions are very casual. You are looking for common ground or similarities that you share. You might talk about your favorite things, such as colors, sports, teachers, etc. Just like the name of the stage, we are experimenting and trying to figure out if we should move towards the next stage or not.

Intensifying

After we talk with the other person and decide that this is someone we want to have a relationship with, we enter the **intensifying** stage. We share more intimate and/or personal information about ourselves with that person. Conversations become more serious, and our interactions are more meaningful. At this stage, you might stop saying “I” and say “we.” So, in the past, you might have said to your partner, “I am having a night out with my friends.” It changes to “we are going out with my friends tonight.” We are becoming more serious about the relationship.

Integrating

The **integrating** stage is where two people truly become a couple. Before they might have been dating or enjoying each other’s company, but in this stage, they are letting people know that they are exclusively dating each other. The expectations in the relationship are higher than they were before. Your knowledge of your partner has increased. The amount of time that you spend with each other is greater.

Bonding

The next stage is the **bonding** stage, where you reveal to the world that your relationship to each other now exists. It might be as simple as a Facebook post. For others, the bonding stage is where they get engaged and have an engagement announcement. For those that are very committed to the relationship, they might decide to have a wedding and get married. In every case, they are making their relationship a public announcement. They want others to know that their relationship is real.

Coming Apart

Some couples can stay in committed and wonderful relationships. However, there are some couples for whom, after bonding, things seem to fall apart. No matter how hard they try to stay together, there is tension and disagreement. These couples go through a coming apart process that involves: differentiating, circumscribing, stagnating, avoiding, and terminating.

Differentiating

The **differentiating** stage is where both people are trying to figure out their own identities. Thus, instead of trying to say “we,” the partners will question “how am I different?” In this stage, differences are emphasized and similarities are overlooked.

As the partners differentiate themselves from each other, they tend to engage in more disagreements. The couples will tend to change their pronoun use from “our kitchen” becomes “my kitchen” or “our child” becomes “my child,” depending on what they want to emphasize.

Initially, in the relationship, we tend to focus on what we have in common with each other. After we have bonded, we are trying to deal with balancing our independence from the other person. If this cannot be resolved, then tensions will emerge, and it usually signals that your relationship is coming apart.

Circumscribing

The **circumscribing** stage is where the partners tend to limit their interactions with each other. Communication will lessen in quality and quantity. Partners try to figure out what they can and can't talk about with each other so that they will not argue.

Partners might not spend as much time with each other at this stage. There are fewer physical displays of affection, as well. Intimacy decreases between the partners. The partners no longer desire to be with each other and only communicate when they have to.

Stagnating

The next stage is **stagnating**, which means the relationship is not improving or growing. The relationship is motionless or stagnating. Partners do not try to communicate with each other. When communication does occur, it is usually restrained and often awkward. The partners live with each other physically but not emotionally. They tend to distance themselves from the other person. Their enthusiasm for the relationship is gone. What used to be fun and exciting for the couple is now a chore.

Avoiding

The **avoiding** stage is where both people avoid each other altogether. They would rather stay away from each other than communicate. At this stage, the partners do not want to see each other or speak to each other. Sometimes, the partners will think that they don't want to be in the relationship any longer.

Terminating

The **terminating** stage is where the parties decide to end or terminate the relationship. It is never easy to end a relationship. A variety of factors can determine whether to cease or continue the relationship. Time is a factor. Couples have to decide to end it gradually or quickly. Couples also have to determine what happens after the termination of the relationship. Besides, partners have to choose how they want to end the relationship. For instance, some people end the relationship via electronic means (e.g., text message, email, Facebook posting) or via face-to-face.

Final Thoughts on Coming Together

Not every relationship will go through each of the ten stages. Several relationships do not go past the experimenting stage. Some remain happy at the intensifying or bonding stage. When both people agree that their relationship is satisfying and each person has their needs met, then stabilization occurs. Some relationships go out of order as well. For instance, in some arranged marriages, the bonding occurs first, and then the couple goes through various phases. Some people jump from one stage into another. When

partners disagree about what is optimal stabilization, then disagreements and tensions will occur.

In today's world, romantic relationships can take on a variety of different meanings and expectations. For instance, "hooking up" or having "friends with benefits" are terms that people might use to describe the status of their relationship. Many people might engage in a variety of relationships but not necessarily get married. We know that relationships vary from couple to couple. No matter what the relationship type, couples decided to come together or come apart.

Relationship Maintenance

You may have heard that relationships are hard work. Relationships need maintenance and care. Just like your body needs food and your car needs gasoline to run, your relationships need attention as well. When people are in a relationship with each other, what makes a difference to keep people together is how they feel when they are with each other. Maintenance can make a relationship more satisfying and successful.

Daniel Canary and Laura Stafford stated that "most people desire long-term, stable, and satisfying relationships."¹¹ To keep a satisfying relationship, individuals must utilize relationship maintenance behaviors. They believed that if individuals do not maintain their relationships, the relationships will weaken and/or end. "It is naïve to assume that relationships simply stay together until they fall apart or that they happen to stay together."¹²

Joe Ayres studied how individuals maintain their interpersonal relationships.¹³ Through factor analysis, he identified three types of strategies. First, *avoidance strategies* are used to evade communication that might threaten the relationship. Second, *balance strategies* are used to maintain equality in the relationship so that partners do not feel underbenefited or overbenefited from being in the relationship. Third, *direct strategies* are used to evaluate and remind the partner of relationship objectives. It is worth noting that Joe Ayers found that relationship intent had a major influence on the perceptions of the relationship partners. If partners wanted to stay together, they would make more of an effort to employ maintenance strategies than deterioration strategies.

Laura Stafford and Daniel Canary (1991) found five key relationship maintenance behaviors (Figure 8.2). First, positivity is a relational maintenance factor used by communicating with their partners in a happy and supportive manner. Second, openness occurs when partners focus their communication on the relationship. Third, assurances are words that emphasize the partners' commitment to the duration



Figure 8.2 Relationship Maintenance Behaviors

of the relationship. Fourth, networking is communicating with family and friends. Lastly, sharing tasks is doing work or household tasks. Later, Canary and his colleagues found two more relationship maintenance behaviors: conflict management and advice.¹⁴

Additionally, Canary and Stafford also posited four propositions that serve as a conceptual framework for relationship maintenance research.¹⁵ The first proposition is that relationships will worsen if they are not maintained. The second proposition is that both partners must feel that there are equal benefits and sacrifices in the relationship for it to sustain. The third proposition states that maintenance behaviors depend on the type of relationship. The fourth proposition is that relationship maintenance behaviors can be used alone or as a mixture to affect perceptions of the relationship. Overall, these propositions illustrate the importance and effect that relationship maintenance behaviors can have on relationships.

Relationship maintenance is the stabilization point between relationship initiation and potential relationship destruction.¹⁶ There are two elements to relationship maintenance. First, strategic plans are intentional behaviors and actions used to maintain the relationship. Second, everyday interactions help to sustain the relationship. Talk is the most important element in relationship maintenance.¹⁷

MINDFULNESS ACTIVITY



Learning how to use mindfulness in our interpersonal relationships is one way to ensure healthy relationships. Lauren Korshak recommends using the RAIN method when interacting with one's relational partners:

- **Recognize:** Nonjudgmentally recognize and name emotions you feel in the present moment.
- **Allow:** Acknowledge, accept, and allow your emotions to be as they are without trying to change them. Allowing does not mean you like what is happening, but that you allow it, dislike and all.
- **Investigate with kindness:** Ask yourself, "What am I experiencing inside my body? What is calling my attention? What does this feeling need from me?"
- **Non-identification/nurture with self-compassion:** Observe thoughts, feelings, and sensations without attaching to them. If you notice painful feelings, nurture them by placing a hand over your heart or speaking words of kindness, reassurance, and compassion, such as "I see you're suffering," or "I'm sorry," or "I love you, I'm listening."¹⁸

For this activity, we want you to use the RAIN method in a conversation with your romantic partner. As an alternative variant, both of you can engage in the RAIN method and discuss a recent conflict you had. The goal is not to establish fault or a win-lose attitude, but rather to learn to empathize with your partner and their perspective.

Key Takeaways

- The coming together stages include: initiating, experimenting, intensifying, integrating, and bonding.
- The coming apart stages include: differentiating, circumscribing, stagnating, avoiding, and terminating.
- Relationship maintenance strategies include positivity, openness, assurances, sharing tasks, conflict management, social networks, and advice.

Exercises

- Find video clips online that illustrate each of the coming together/coming apart stages. Show them to your class. Do you agree/disagree?
- Do a self-analysis of a relationship that you have been involved with or have witnessed. How did the two people come together and come apart? Did they go through all the stages? Why/why not?
- Write down an example of each the relationship maintenance strategies. Then, rank order in terms of importance to you. Why did you rank them the way that you did? Find a peer and compare your answers.

8.4 Communication in Relationships

LEARNING OUTCOMES

1. Learn how communication varies.
2. Analyze relationship dialectics.
3. Understand self-disclosure in relationships.

Relationship Dialectics

We know that all relationships go through change. The changes in a relationship are usually dependent on communication. When a relationship starts, there is a lot of positive and ample communication between the parties. However, sometimes couples go through a redundant problem, and it is important to learn how to deal with this problem. Partners can't always know what their significant other desires or needs from them.

Dialectics had been a concept known well to many scholars for many years. They are simply the pushes and pulls that can be found every day in relationships of all types. Conversation involves people who must learn to adapt to each other while still maintaining their individuality.¹⁹ The theory emphasizes interactions allowing for more flexibility to explain how couples maintain a satisfactory, cohesive union. This perspective views relationships as simply managing the tensions that arise because they cannot be fully resolved. The management of the tensions is usually based on past experiences; what worked for a person in the past will be what they decide to use in the future. These tensions are both contradictory and interdependent because without one, the other is not understood. Leslie A. Baxter, the scholar who developed this theory, pulled from as many outside sources as she could to better understand the phenomenon of dialectical tensions within relationships. The development began by closely studying the works of Mikhail Bakhtin, who was a Russian scholar of culture, literature, philosophy, and language. Baxter was interested in his life's work; the theory often was referred to as dialogism. Bakhtin argued that life is a social process of dialogue that is characterized by the concurrent coming together and separating of individual perspectives.

Early in Baxter's career, she noticed that while she was interested in the termination of relationships, her colleagues were interested in the beginnings. Although her colleagues were interested in disclosure, she was interested in non-disclosure. At this point, it still had not occurred to her that these opposing

interests in research would lead her to the understanding of dialectical tensions. She continued to research these subjects and read as much as she could on Marxist and Hegelian dialectics as she found these writings to be both fascinating and frustrating. She processed these writings slowly, and the concepts slowly began to show up in her work. In 1993, Baxter and Montgomery began writing a book on dialectics called *Relating: Dialogues and Dialectics*. This was her first official work done on dialectics and its conversational effects. She continued writing about dialectics and continued to expand the concepts as she further researched families, romantic relationships, and friendships. Since then, Baxter has continually changed and shifted her studies to find new and better ways to use the theory. After conducting a series of in-depth interviews, both Baxter and Montgomery began to see themes in the tensions experienced in romantic relationships. Their overarching research premise (which is applicable to all relationships, including mother/daughter relationships) is that all personal ties and relationships are always in a state of constant flux and contradiction. Relational dialectics highlight a “dynamic knot of contradictions in personal relationships; an unceasing interplay between contrary or opposing tendencies.”²⁰ The concept of contradiction is crucial to understanding relational dialectics. The contradiction is when there are opposing sides to a situation. These contradictions tend to arise when both parties are considered interdependent. Dialectical tension is natural and inevitable. All relationships are complex because human beings are complex, and this fact is reflected in our communicative processes. Baxter and Montgomery argue that tension arises because we are drawn to the antitheses of opposing sides. These contradictions must be met with a “both/and” approach as opposed to the “either/or” mindset. However, the “both/and” approach lends to tension and pressure, which almost always guarantees that relationships are not easy.

Dialectical tension is how individuals deal with struggles in their relationship. There are opposing forces or struggles that couples have to deal with. It is based on Leslie Baxter and Barbara Montgomery’s Relational Dialectics Theory in 1996. Below are some different relational dialectics.²¹

Separation-Integration

This is where partners seek involvement but are not willing to sacrifice their entire identity. For instance, in a marriage, some women struggle with taking their partner’s last name, keeping their maiden name or combining the two. Often when partners were single, they might have engaged in a girl’s night out or a guy’s night out. When in a committed relationship, one partner might feel left out and want to be more involved. Thus, struggles and conflict occur until the couple can figure out a way to deal with this issue.

Predictability–Novelty

This deals with rituals/routines compared to novelty. For instance, for some mothers, it is tough to accept that their child is an adult. They want their child to grow up, at the same time it is difficult to recognize how their child has grown up.

Openness–Closedness

Disclosure is necessary, but there is a need for privacy. For some couples, diaries work to keep things private. Yet, there are times when their partner needs to know what can’t be expressed directly through words.

Similarity-Difference

This tension deals with self vs. others. Some couples are very similar in their thinking and beliefs. This is good because it makes communication easier and conflict resolution smoother. Yet, if partners are too similar, then they cannot grow. Differences can help couples mature and create stimulation.

Ideal-Real

Couples will perceive some things as good and some things as bad. Their perceptions of what is real may interfere with or inhibit perceptions of what is real. For instance, a couple may think that their relationship is perfect. But from an outsider, they might think that the relationship is abusive and devastating.

Another example might be that a young dating couple thinks that they do not have to marry each other because it is the ideal and accepted view of taking the relationship to the next phase. Thus, the couples move in together and raise a family without being married. They have deviated from what is an ideal normative cultural script.²²

Every relationship is fraught with these dialectical tensions. There's no way around them. However, there are different ways of managing dialectical tensions:

- Denial is where we respond to one end.
- Disorientation is where we feel overwhelmed. We fight, freeze, or leave.
- Alternation is where we choose one end on different occasions.
- Recalibration is reframing the situation or perspective.
- Segmentation is where we compartmentalize different areas.
- Balance is where we manage and compromise our needs.
- Integration is blending different perspectives.
- Reaffirmation is having the knowledge & accepting our differences.

Not every couple deals with dialectical tensions in the same way. Some will use a certain strategy during specific situations, and others will use the same strategy every time there is tension. You have to decide what is best for you based on the situation.

Self-Disclosure

In Chapter 7, we started our discussion of self-disclosure. We discussed Sidney Jourard's basic definition of self-disclosure, "the act of making yourself manifest, showing yourself so others can perceive you."²³ Jourard believed that self-disclosure was necessary to have good mental health. All in all, Jourard took a very humanistic or health approach to self-disclosure because he deemed that it was an essential and integral part of our wellbeing.

Individuals disclose for a variety of reasons. Sandra Petronio has presented five potential reasons for self-disclosure: (a) expression, (b) self-clarification, (c) social value, (d) relationship development, and (e) social control and influence.²⁴ Petronio explained, "for each type of disclosure, there is a corresponding expectation communicated that influences the choice of response."²⁵

Four considerations are pertinent to disclosure.²⁶ First, the type of relationship will affect individuals' need to disclose. The more significant the disclose is to the discloser, then the greater the need more to disclose information. Second, the disclosure has a risk-to-benefits ratio. In other words, individuals who disclose certain types of information, may risk losing certain things (i.e., career or pride) or may

benefit certain things (i.e., trust or security). Third, the appropriateness and relevance to the situation impacts what gets disclosed and what does not get disclosed. Fourth, disclosure depends on reciprocity. Individuals will disclose similar amounts of information to each other.

The amount of disclosure that we are willing to share with others also depends on other factors. It is based on honesty, depth, availability of information, and the environment.

First, when we disclose to others, we can truly reveal characteristics about ourselves, or we can lie. In a recent study, it was found that most college students lie when initially meeting someone new for the first time. The cause is because we want to impress others. A lot of deception occurs in online chatrooms because sometimes people do not want to reveal who they really are, because of possible repercussions.

Depth is another factor of self-disclosure. When I talk to my parents, I can share hours of information about my day with them. I can talk about all sorts of things with them. However, I have a friend who is only willing to talk about the weather and what he ate with his parents. As you can see, the depth of information is very different. One person only talks about superficial facts, and the other person delves a lot deeper and is willing to discuss more themselves.

The availability of information has an impact as well. For instance, if you have more information on a certain topic, you might be willing to share more comments on the matter. For instance, say you and your friends are trying to decide which presidential candidate to support in the next election. You might be more willing to self-disclose what you know about a candidate and your opinions about that candidate based on your information. However, you might be less willing to comment on another candidate if you don't know their platform or background.

The context or environment also has an impact on self-disclosure. For instance, have you ever noticed that people tend to open up about themselves when they are in a confined space, such as an airplane? It is so interesting to see how people are willing to share personal information about themselves with a total stranger only because the other person is doing it as well.

Alternatives to Self-Disclosure

So, if you don't want to self-disclose to others, what are some techniques that you can use? First, you can use deception. Sometimes people lie simply to avoid conflict. This is true in cases where the person may become extremely upset. They can lie to gain power or to save face. They can also lie to guide the interaction.

Second, you can equivocate. This means you don't answer the question or provide your comments. Rather, you simply restated what they said differently. For instance, Sally says, "how do you like my new dress?", you can say "Wow! That's a new outfit!" In this case, you don't provide how you feel, and you don't disclose your opinion. You only offer the information that has been provided to you.

Third, you can hint. Perhaps, you don't want to lie or equivocate to someone you care about. You might use indirect or face-saving comments. For example, if your roommate has not helped you clean your apartment, you might say things like, "It sure is messy in here" or "This place could really use some cleaning."

Key Takeaways

- Communication is personalized. It can be symmetrical or complementary. Communication has two levels - content and relational.
- Relationship dialectics are tensions that happen in a relationship. Partners have to

- deal with integration vs. separation, stability vs change, and expression vs. privacy.
- Self-disclosure is important in relationships because it allows you to share more information about yourself with another person.

Exercises

- Find a transcript of your favorite television sitcom on the Internet. See if you can identify which types of communication is relational/content and which are symmetrical/complementary.
- Consider three different issues that you might be dealing in a relationship that you have with another person. What are the relationship dialectic tensions? How are you handling these tensions? Identify what strategy you are using to deal with this tension. Why?
- Create a list of all the reasons you would disclose and why you would not disclose. Discuss the finding in class. Were there differences or similarities?

8.5 Dating Relationships

LEARNING

OUTCOMES

1. Define the term “date” and the supracategories associated with the term.
2. Describe the importance of scripts in dating relationships.
3. Differentiate among the five types of love.

We talk of dating as a single construct a lot of the time without really thinking through how dating has changed over time. In the 20th Century alone, we saw dating go from a highly formalized structure involving calling cards and sitting rooms; to drive-in movies in the back seat of a car; to cyberdating with people we’ve never met.²⁷ The 21st Century has already changed how people date through social networking sites and geolocation dating apps on smartphones. Dating is not a single thing, and dating has definitely changed with the times.

So, with all of this change, how does one even begin to know if someone’s on a date in the first place? Thankfully Paul Mongeau, Janet Jacobsen, and Carolyn Donnerstein have attempted to answer this question for us.²⁸ The researchers found that there are five of what they called “supracategories” that help define the term “date”: communication expectations, date goals, date elements, dyadic, and feelings. First, dating involves specific communication expectations. For example, people expect that there will be a certain level of self-disclosure on a date. Furthermore, people expect that their dating partner will be polite, relaxed, and social. Second, dating involves specific date goals, or people on dates have specific goals (e.g., future romantic relationships, reduce uncertainty, have fun). Third, there are specific date elements. For example, someone has to initiate the date; we get ready for a date, we know when the date has started and stopped, there are activities that constitute the date, etc. Fourth, dates are dyadic, or dating is a couple-based activity. Now, this doesn’t necessarily take into account the idea of “group dates,” but even on a group date traditionally there are dyadic couples that are involved in the date itself. Lastly,

dates involve feelings. “These feelings range from affection (nonromantic feelings or behaviors), attraction (physical and/or emotional attraction toward the partner), to romantic (dates have romantic overtones).”²⁹

Dating Scripts

All of us are going to spend a portion of our lives in some kind of dating relationship. Whether we are initiating dates, dating, or terminating relationships, we spend a great deal of time dating. Match.com publishes an annual study examining singles in the United States (<https://www.singlesinamerica.com/>). According to data from 2018,³⁰ here are some of the realities of modern single life:

- 55.8% did not go on any first dates, while only 12.6% went on one first date.
- Of those who went on a first date, 20.3% met the person on an online dating site/app while 15.6% met the person through a friend.
- When it comes to being passionately in love, 19.4% have never been in love, 27.3% have been in love once, and 27.7% have been in love twice.
- 25.1% have a “checklist” when it comes to finding a long-term romantic partner.
- 66.7% believe that loving someone is hard work.
- 75.2% believe that love is a possibility for them.
- 83.5% believe that love is hard to find in today’s world.
- 32.4% of dating partners have disagreed on how to label their relationship, and 23.0% have left a relationship over this disagreement.
- When it comes to first dates, participants preferred either quick and easy (36.0%, e.g., coffee, drinks) or more formal (21%, e.g., dinner, brunch).
- 38.1% had been in a “friends with benefits” relationship.
- 28.3% had a friendship that turned into a significant romantic relationship.
- 41.1% have dated someone they met online.
- 48.9% had created at least one profile on a dating website or app.

Admittedly, this study is probably pretty heterosexist because the data were not broken down by sexual orientation. Furthermore, we don’t have similar data for bisexual, gay, and lesbian couples. Dating is one of those things we will spend a lot of time doing before we ever settle down and get married (assuming you ever do or have a desire to do so). So, one must imagine that with so much dating going on in the world, we’d have a pretty good grasp of how dating works.

Robert Abelson originally proposed the idea of script theory back in the late 1970s.³¹ He defined a script as a “coherent sequence of events expected by the individual, involving him as either a participant or an observer.”³² According to script theory, people tend to pattern their responses and behaviors during different social interactions to take control of that situation. This does require an individual to be able to imagine their past, present, and future behavior to create this script.³³ In 1993, Suzanna Rose and Irene Frieze applied Abelson’s notions of script theory to dating. They had college students keep records of what they did on a date. Ultimately, two different scripts were derived: one for men and one for women. The male script consisted of 15 different behavioral actions (all initiated by the male):³⁴

1. Picked up date
2. Met parents/roommates
3. Left

4. Picked up friends
5. Confirmed plans
6. Talked, joked, laughed
7. Went to movies, show, party
8. Ate
9. Drank alcohol
10. Initiated sexual contact
11. Made out
12. Took date home
13. Asked for another date
14. Kissed goodnight
15. Went home

Women's scripts, on the other hand, contained both behavioral actions for themselves and behavioral actions they expected of the man during the date:³⁵

1. Groomed and dressed
2. Was nervous
3. Picked up date (male)
4. Introduced to parents, etc.
5. Courteous behavior (open doors-male)
6. Left
7. Confirmed plans
8. Got to know & evaluate date
9. Talked, joked, laughed
10. Enjoyed date
11. Went to movies, show, party
12. Ate
13. Drank alcohol
14. Talked to friends
15. Had something go wrong
16. Took date home (male)
17. Asked for another date (male)
18. Told date will call her (male)
19. Kissed date goodnight (male)

Take a second and go through these two lists. Do you think they still apply today? How do you think these scripts differ? Once again, these dating scripts were created only using heterosexual college students. Do you think these scripts change if you have people dating in their late 20s or 30s? What about people who date in their 70s, 80s, or 90s?

There has been subsequent research in the area of dating scripts. Table 8.1 demonstrates some of the other dating scripts that researchers have found (this is not an exhaustive list).

First Date ³⁶	Gay Men ³⁷	Lesbians ³⁸	Deaf College Students ³⁹
<ul style="list-style-type: none"> • Get ready • Pick up date (M) • Feel nervous • Go to movie • Pay (M) • Talk • Hold hands • Go to café/party • Nonverbal closeness • Talk • Drink alcohol • Touch/hug • Deep conversation • Mingle with others • Talk • Leave party • Invite the other in • Walk/drive home (M) • Polite leave-taking • Kiss • Future plans • Part for the night (M) 	<ul style="list-style-type: none"> • Discussed plans • Was nervous • Groomed/dressed • Went to date's house/picked up date. • Met at pre-arranged location • Left one location for another • Got to know /evaluated date • Talked/laughed/joked • Talked to friends while on date • Went to a movie, show, etc. • Ate/drank non-alcohol • Drank alcohol/used drugs • Initiated physical contact • Made out • Had sex • Stayed over • Made plans for another date • Went home 	<ul style="list-style-type: none"> • Discussed plans • Was nervous • Groomed/dressed • Prepared (cleaned apt., bought flowers, etc.) • Went to date's house/ picked up date • Left • Got to know/ evaluated date • Talked/laughed/joked • Went to a movie, show, etc. • Ate/drank non-alcohol • Positive affect • Drank alcohol/used drugs • Initiated physical contact • Kissed/hugged goodnight • Took date home • Went home • Evaluated feelings post-date 	<ul style="list-style-type: none"> • Initiation/meeting <ul style="list-style-type: none"> ▸ Talk ▸ Shared interest ▸ Family and friends <ul style="list-style-type: none"> ▸ Meet in public • Date activities <ul style="list-style-type: none"> ▸ Group activities ▸ Dinner ▸ Movie ▸ Talk • Outcomes/conclusions <ul style="list-style-type: none"> ▸ Good night kiss ▸ Take date home ▸ Hug ▸ Relationship development

(M) denotes male behavior

Table 8.1 Dating Scripts

We often think of dating as something that occurs purely among young people before they get married, but we know people in all age groups date and are looking for romantic relationships of all shapes and sizes.

One other facet of script theory that is very important to consider is how we learn these scripts in the first place. As you read through both the male and female dating script, did you consciously think about how you learned to date? Of course not! However, we've been conditioned since we were very young to date. We've listened to adults tell stories of dating. We've watched dating as it is fictionalized on television and in movies. Dating narratives surround us, and all of these narratives help create the dating scripts that we have. Although dating may feel like you're making it up as you go along, you already

possess a treasure trove of information about how dating works. Thankfully, because we have these cultural images of dating presented to us, we also know that our dating partner (as long as they are from a similar culture) will have similar dating scripts.

Research Spotlight



One area that has received a decent amount of attention in script theory is sexual scripts, or scripts people engage in when thinking about “who can participate, what the participants should do (i.e., what verbal and nonverbal behaviors should be included and in what order they should be used), and where the sexual episode should take place.”⁴⁰ In 1993, Timothy Edgar and Mary Anne Fitzpatrick proposed a sexual script theory for communication.⁴¹ In 2010, this script was further evaluated by Betty La France. In La France’s study, she wanted to examine the verbal and nonverbal communication behaviors that lead to sex. Starting with Edgar and Fitzpatrick’s sexual scripts, La France narrowed the list down to the following:

Public Setting Script	Private Setting Script (Her Apartment)
<p>Craig was standing at the bar when he noticed Sarah.</p> <p>She also noticed him.</p> <p>There was eye contact between them.</p> <p>She glanced away.</p> <p>He approached her.</p> <p>“Hi, my name is Craig,” he said.</p> <p>“I’m Sarah. How are you doing?” she replied.</p> <p>“Can I buy you a drink?” he asked.</p> <p>Craig asked, “Are you alone?”</p> <p>“No, I came with some friends,” she replied.</p> <p>Craig asked her questions about herself, such as where she was from and what her major was.</p> <p>She responded to his questions.</p> <p>In return, Sarah asked Craig similar questions about himself.</p>	<p>She brought him a drink.</p> <p>“Want to listen to some music?” asked Sarah.</p> <p>She put on the music.</p> <p>Craig asked, “Are your roommates around?”</p> <p>“This is a great apartment,” said Craig.</p> <p>He sat next to her on the couch.</p> <p>They engaged in casual conversation.</p> <p>There was eye contact between them.</p> <p>He moved closer to her.</p> <p>“You are so beautiful,” said Craig.</p> <p>He put his arm around her.</p> <p><i>Bedroom setting</i></p> <p>He undressed her.</p> <p>Craig started to undress himself.</p> <p>Sarah helped him to undress.</p> <p>They discussed whether they should use protection.</p> <p>Craig put on a condom.</p>

As for the results of this study, La France found that people predicted that as the sexual scripts progressed, the likelihood that Sarah and Craig were going to have sexual intercourse increased. Overall, La France found that the sequence of both verbal and nonverbal sexual behaviors could predict the likelihood that people believed that Sarah and Craig would have sex. For example, in the public setting script, when Sarah says, “No, I came

with some friends,” this caused people to think that sex could be off-the-table because the statement indicates that the likelihood of the two leaving alone is less likely.

La France, B. (2010). What verbal and nonverbal communication cues lead to sex? An analysis of the traditional sexual script. *Communication Quarterly*, 58(3), 297–318. <https://doi.org/10.1080/01463373.2010.503161>

Love Styles

An individual’s love style is considered to be an attitude and describes how love is perceived.⁴² Attitudes toward love and perceptions of love may change throughout an individual’s life. College students may perceive love very differently from their parents or guardians because college students are in a very different stage of life. College students are living among people their age who are more than likely single or unmarried. These two factors mean that there are more prospects for dating, and this may lead the college student to conclude that dating any number of these prospects is necessary or even perceive that “hooking up” with multiple prospects is acceptable. In contrast, individuals with children who are financially tied may view romantic relationships as partnerships in which goal achievement (pay off the house, send kids to college, pay off debt, etc.) is as important as romance. These differences in perceptions of love can be explored through John Lee’s love typology in which he discusses six love styles: eros, storge, ludus, agape, pragma, and mania (Figure 8.3).⁴³

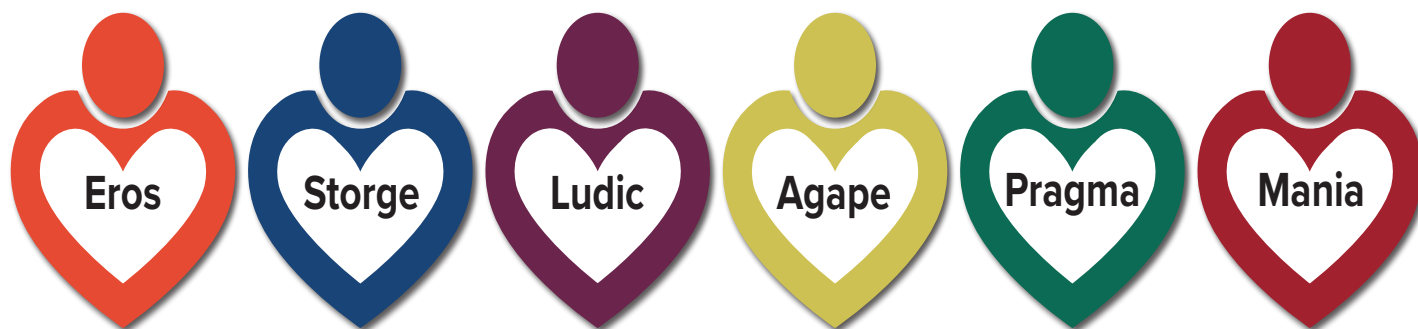

Figure 8.3 Love Styles

Eros

Eros is romance and emphasizes love and physical beauty, immediate attraction, emotional intensity, and strong commitment. Eros love involves the early initiation of sexual intimacy and consecutive monogamous relationships.

Storge

Storge love develops slowly out of friendship where stability and psychological closeness are valued along with commitment, which leads to enduring love. Passion and intense emotions are not valued as they are in the eros love style. One of the author’s uncles was in his 60s and had never been married. However, he employed a woman who cooked and cleaned for him for over 20 years. His family was very surprised to receive an announcement that he was marrying the individual who took care of him for so long. The formation of their love is a great example of love that arises slowly out of friendship.

Ludic

Ludic lovers view love as a game, and playing this game with multiple partners is perceived to be acceptable by individuals with this love style. As such, this type of lover believes that deception and manipulation are acceptable. Individuals with this love style have a low tolerance for commitment, jealousy, and strong emotional attachment.

Agape

In contrast, **agape** love involves altruism, giving, and other-centered love. This love style approaches relationships in a non-demanding style with gentle caring and tolerance for others.

Pragma

Pragma love is known as practical love involving logic and reason. Arranged marriages were often arranged for functional purposes. Kings and Queens of different countries often married to form alliances. This love style may seek out a romantic partner for financial stability, ability to parent, or simple companionship.

Mania

Mania is the final love style characterized by dependence, uncertainty, jealousy, and emotional upheaval. This type of love is insecure and needs constant reassurance.

These love styles should not be considered to be mutually independent. An individual may approach love from a pragmatic stance and have found love that provides financial stability. However, they still feel insecure (representative of mania) about whether their romantic partner will remain with them, thus ensuring continued financial stability. It is important to remember that individuals engage in each of these love styles, and it is simply a matter of how much of each love style a person possesses.

Research Spotlight



In 2015, Alexander Khaddouma, Kristina Coop Gordon, and Jennifer Bolden set out to examine the relationship between mindfulness and relational satisfaction in dating relationships. The researchers predicted that mindfulness would lead to a greater sense of differentiation of self, which would then lead to greater relationship satisfaction. Differentiation of self has two basic components:

On an intrapsychic level, differentiation of self refers to an individual's ability to distinguish between thoughts and feelings and purposefully choose one's responses to these thoughts and feelings in present situations.

On an interpersonal level, differentiation of self refers to an individual's ability to balance intimacy and autonomy in relations with others.⁴⁴

The concept of differentiation of self stems out of a body of research called family systems theory, which we'll discuss in more detail in Chapter 11. For now, it's important to understand that highly differentiated people have healthier levels of personal autonomy in their interpersonal relationships. Conversely, "less differentiated individuals are considered to be more automatically and emotionally reactive in stressful situations and have difficulty maintaining a stable, autonomous sense of self in close relationships."⁴⁵

In this study, the researchers found that mindfulness led to greater differentiation of self, which in turn, led

to greater overall relationship satisfaction.

Khaddouma, A., Gordon, K. C., & Bolden, J. (2015). Zen and the art of dating: Mindfulness, differentiation of self, and satisfaction in dating relationships. *Couple and Family Psychology: Research and Practice*, 4(1), 1-13. <https://doi.org/10.1037/cfp0000035>

Key Takeaways

- Mongeau, Jacobsen, and Donnerstein defined the term “dating” by identifying a series of “supracategories” that help define the term: communication expectations, date goals, date elements, dyadic, and feelings.
- The idea of script theory was originally proposed by Abelson who defined the concept of scripts as sequences of events expected by a participant or an observer. Dating scripts, therefore, are patterns of behavior that are expected during a “date.”
- There are six different love styles. Eros is romance and emphasizes love and physical beauty, immediate attraction, emotional intensity, and strong commitment. Second, storge love develops slowly out of friendship where stability and psychological closeness are valued along with commitment, which leads to enduring love. Third, ludic lovers view love as a game, and playing this game with multiple partners is perceived to be acceptable by individuals with this love style. Fourth, agape love involves altruism, giving, and other-centered love. Fifth, pragma love is known as practical love involving logic and reason. Lastly, mania love is characterized by dependence, uncertainty, jealousy, and emotional upheaval.

Exercises

- Compare a current or past romantic relationship to the definition of romantic relationships provided in this chapter. What are the similarities and differences in your romantic relationship?
- List the physical features you find attractive. List the personality factors you find attractive. Would you have a romantic relationship with someone who possessed the personality characteristics you find attractive, but not the physical characteristics? Why or why not? Now, consider whether you would have a romantic relationship with someone physically attractive, but who did not possess the personality characteristics you find attractive. Would you have a romantic relationship with this individual? Why or why not?
- List and define each love style. List the love style of each of your parents and grandparents. Explain how your love style developed and whether it was learned from a family member or innate.

8.6 How Gender Affects Relationships

LEARNING

OUTCOMES

1. Discern the difference between sex and gender.
2. Understand the sex and gender differences in communication.
3. Discover ways to improve communication.

Biological Sex vs. Gender

Sex refers to one's biological status as male or female, as determined by chromosomes and secondary sex characteristics. **Gender**, however, refers to the behaviors and traits society considers masculine and feminine.⁴⁶ Shuhbra Gaur stated "the meaning of gender, according to her, depends on the ways a culture defines femininity and masculinity which lead to expectations about how individual women and men should act and communicate; and how individuals communicate establishes meanings of gender that in turn, influence cultural views."⁴⁷ That being said, you can have a female that has a masculine gender and, conversely, a male that has a feminine gender. Gender is all about how society has taught one to perceive the surrounding environment. The different traits that an individual displays is how one interprets gender, while other traits depict how an individual was raised and developed. Heidi Reeder noted that "In Western culture the stereotypically masculine traits include aggressiveness, independence and task orientation. Stereotypically feminine traits include being helpful, warm and sincere."⁴⁸ Sex is predetermined, and in most cases, it cannot be changed, but gender, on the other hand, is fluid and can vary in many different ways.

Gender is formed at a young age and then reinforced for the remainder of a lifetime. That does not mean that gender cannot be changed; it just means that one would be going against what gender society deems an individual should be. Gender comes from communication from influential figures in a person's life. Gender plays a major role in perceived closeness and disclosure.⁴⁹

When we talk about gender, we are not considering what the person is born physically. Rather, we consider what the person feels psychologically. Sandra Bem (1974) was interested in gender roles. She created a Bem Sex Role Inventory (BSRI). Based on her findings, she was able to categorize four types of genders: **feminine, masculine, androgynous** (a combination of both feminine and masculine traits), and **undifferentiated** (neither masculine or feminine).⁵⁰ When you combine sex and gender together, you can have eight different combinations: masculine males, feminine males, androgynous males, undifferentiated males, masculine females, feminine females, androgynous females, undifferentiated females.⁵¹ Most people will perceive themselves as sex-typed or androgynous, rather than undifferentiated.

Bem's work in gender has been eye-opening. She contended that there are three main gender perspectives in Western culture. First, males and females are psychologically different. Second, males are considered more dominating than females. Third, the differences between males and females are natural. If we can understand these basic differences, then we can communicate and function better.

Gender Differences in Interpersonal Communication

Each of the gender types will communicate differently. Feminine females will perceive interpersonal relationships as possibilities to nurture, to articulate their emotions and feelings. Whereas, masculine males will view interpersonal relationships as competition and the potential for gaining something. Androgynous male and androgynous females do not differ much in terms of their perceptions of interpersonal relationships. However, androgynous males and females, as well as feminine females are likely to sympathize with others more than masculine males.⁵²

Sex Differences in Interpersonal Communication

In the United States, we have expectations for how males and females should communicate and behave.⁵³ We learn sex differences at a very young age. Boys and girls play, perform, dress, and respond to things very differently. Girls are taught that it is okay to cry in public, but boys are taught to “be a man.” It is acceptable for boys to pretend to play guns and for girls to pretend to play being mothers. Males are conditioned to have **instrumental** roles, which are task-oriented responsibilities. Females are conditioned to have **expressive** roles, which are focused on helping and nurturing others, which are relationship-oriented roles.

Improving Communication Skills

Many popular guides to enhancing communication skills place particular emphasis on exploring your own needs, desires, and motives in the relationship. Some of the goals you have in a relationship may be subconscious. By becoming more aware of these goals, and what you want to achieve in a relationship, you can identify areas of the relationship that you would like to improve and generate ideas for making these changes.

Because people in relationships are interconnected and interdependent, it takes people willing to be open about their needs and relationship goals and willing to work on improving communication and, hence, the relationship in general.

As discussed previously, clear communication is necessary to give and receive information. Words have multiple denotations and connotations, and word choice is critical when you communicate about areas of your relationship that are not satisfying. Asking for and providing clarification and sending explicit messages, obtaining feedback to be sure that you are understood, and listening carefully to the feedback are all important components in effective communication. Finally, when you communicate, remember that everyone wants to be heard, to feel valued, to know that they matter, and to be assured that their ideas are important.

Key Takeaways

- Sex is biological, and gender is psychological.
- Males tend to communicate instrumentally, and females tend to communicate expressively.
- By becoming more aware of your goals and open to talk about the other person’s needs, you can improve your communication.

Exercises

- As a class, ask everyone to write down all the characteristics of males and females. Then, ask one person to write each word on a post-it note. Then, on the board in front of the class divide it into two sections: males and females. Each student will get the opportunity to put the words into the male or female section. Have a discussion to see if you all agree.
- Ask all the males to step out of the classroom and ask all the females to stay in the classroom. Each group will come up with ten questions that they always wanted to know about the opposite sex. For instance, why do girls open their mouths when putting on mascara? Or why do boys recall sports information so well? Come back into the classroom together and designate a spokesperson for each side. Males will ask their questions to the females, and females will ask their questions to the males. Each side will get to respond as a group. Why did you answer the way you did? Are there truly differences between males and females?
- On a sheet of paper, divide into two parts and label one side as male and one side as female. Complete the sentence: Males are _____ and Females are _____. Write your words on your paper. Try to write down ten possible answers for females and males. As a class, compare what you wrote down.

Chapter Wrap-Up

In this chapter, we've explored the range of issues related to building and maintaining relationships. We started by discussing the nature of relationships, which included a discussion of the characteristics of relationships and the importance of significant relationships. We then discussed the formation and dissolution of relationships. Then we explored the importance of communication in relationships. Lastly, we looked at dating relationships and ended by discussing gender and building and maintaining relationships takes a lot of work.

End of Chapter

KEY TERMS

- Agape
- Androgynous
- Attraction
- Avoiding
- Bonding
- Circumscribing
- Comparison Level
- Comparison Level of Alternatives
- Compatible
- Complementary
- Contact Frequency
- Content Level
- Differentiating
- Duration
- Empathy
- Eros
- Experimenting
- Expressive
- Gender
- Goals
- Hedge
- Initiating

- Instrumental
- Integrating
- Intensifying
- Interaction Variability
- Interdependent
- Intimacy
- Love
- Love Style
- Ludus
- Mania
- Physical Attraction
- platonic
- Pragma
- Relationship
- Relationship Dialectic
- Relationship Level
- Relationship Maintenance
- Romantic Relationships
- Self-Disclosure
- Sex
- Sharing
- Social Attraction
- Stagnating
- Storge
- Support
- Symmetrical Relationship
- Task Attraction
- Terminating

REAL WORLD CASE STUDY

Bill and Hillary have been dating each other since they were first-year students in college. They know that they would like to possibly get married and start a family. Before graduation, Bill finds out that he got his dream job offer in another city. Hillary wants to stay in the same college town, where she grew up and her family lives. She does not want to move. In addition, she got a job offer in the same town that would be beneficial for her. In the long-term, Hillary thinks that Bill should give up his dream job and sacrifice it for love and their future together. Bills thinks she is being selfish. He thinks he could make enough money so that they could travel back to see her family often. He thinks she is being selfish for not thinking about his feelings and his dreams. Bill knows that he will never get another opportunity like this again. He also knows he will not find another woman like Hillary. Hillary loves Bill, but she also loves her family. She doesn't want a long-distance relationship with either of them. Hilary thinks that if they have their own family, it would be ideal to have other family members close to them.

1. What would you do if you were Hillary/Bill?
2. How do you determine the best decision?
3. What are some possible solutions, and what would be the best solution?
4. If they decide to get married, how do they determine when would be best and when to have kids?
5. What kind of topics do Bill and Hillary need to agree on first?

END OF CHAPTER QUIZ

- Picking a seat in class near the person you'd like to get to know is an example of
 - offering
 - approaching
 - networking
 - self-disclosing
 - sustaining
- The fact that we are likely to pick a mate with whom we frequently cross paths is due to which reason for forming relationships?
 - appearance
 - proximity
 - similarity
 - reciprocity
 - differences
- After 20 years of marriage, Chad and Autumn are bored in their relationship. They know what the other person will do and say every day. This dialectical tension is:
 - integration-separation
 - expression -privacy
 - stability-change
 - altruistic-selfishness
 - complementary-symmetrical
- Aubrey loves to eat Asian food, but Gavin would rather just eat American food. The way the deal with their tensions is to say that they both love to eat food. The strategy they are most likely using is:
 - denial
 - recalibration
 - integration
 - balance
 - reaffirmation
- Anna, who is a counselor at a women's crisis center, says the reason she most often hears from battered wives for returning to their husbands is, "I don't have any other place to go." Which explanation of why people perform relationships best predicts this relationship?
 - disclosure thesis that suggests we are attracted to those who use disclosure appropriately
 - the reward thesis that suggests we are attracted to people we believe are can give us rewards
 - the similarity thesis that suggests we like people whom we perceive are like us
 - exchange theory that suggests we form relationships through assessment of potential rewards and costs
 - the reciprocity thesis that suggests being liked by others is a strong source of attraction

References

- 1 News Agencies. (2014, January 1). Average woman will kiss 15 men and be heartbroken twice before meeting “The One,” study reveals. *The Telegraph*. <https://tinyurl.com/sm5ufph>
- 2 Gervis, Z. (2019, May 9). Why the average American hasn’t made a new friend in five years. *SWNS digital*. <https://tinyurl.com/yxtc2htg>
- 3 Gamble, T. K., & Gamble, M. W. (2014). *Interpersonal communication: Building connections together*. Sage.
- 4 Punyanunt-Carter, N. M. (2004). Reported affectionate communication and satisfaction in marital and dating relationships. *Psychological Reports*, 166(3), 1049-1055. <https://doi.org/10.2466/pr0.95.3f.1154-1160>
- 5 Samovar, L. A., & Porter, R. E. (1995). *Communication between cultures* (2nd ed.). Wadsworth, p. 188.
- 6 Stafford, L. (2008). Social exchange theories. In L. A. Baxter & D. O. Braithwaite (Eds.), *Engaging theories in interpersonal communication: Multiple perspectives* (pp. 377-389). Sage.
- 7 Adler, R., Rosenfeld, L. B., & Proctor II, R. F. (2013). *Interplay: The process of interpersonal communication*. Oxford.
- 8 Dindia, K. (2000). Self-disclosure research: Advances through meta-analysis. In M. A. Allen, R. W. Preiss, B. M., Gayle, & N. Burrell (Eds.). *Interpersonal communication research: Advances through meta-analysis* (pp. 169-186). Erlbaum.
- 9 Knapp, M. L. (1984). *Interpersonal communication and human relationships*. Boston, MA: Allyn & Bacon.
- 10 Knapp, M. L., & Vangelisti, A. L. (1992). *Interpersonal communication and human behavior* (2nd ed.). Allyn & Bacon.
- 11 Canary, D. J., & Stafford, L. (1994). Maintaining relationships through strategic and routine interaction. In D. J. Canary & L. Stafford (Eds.). *Communication and relational maintenance* (pp. 3-21). Academic Press; pg. 4.
- 12 Ibid.; pg. 220.
- 13 Ayers, J. (1983). Strategies to maintain relationships: Their identification and perceived usages. *Communication Quarterly*, 31(1), 62-67. <https://doi.org/10.1080/01463378309369487>
- 14 Canary, D. J., & Zelle, E. D. (2000). Current research programs on relational maintenance behaviors. *Communication Yearbook*, 23, 305-340.
- 15 Canary, D. J., & Stafford, L. (1994). Maintaining relationships through strategic and routine interaction. In D. J. Canary & L. Stafford (Eds.). *Communication and relational maintenance* (pp. 3-21). Academic Press.
- 16 Duck, S. (1988). *Relating to others*. Dorsey Press.
- 17 Duck, S. (1994). Steady as (s)he goes: Relational maintenance as a shared meaning system. In D. J. Canary & L. Stafford (Eds.). *Communication and relational maintenance* (pp. 45-60). Academic Press.
- 18 Korshak, L. (2019). *The mindful relationship: Easy exercises to make mindfulness a daily relationship practice*. Rockridge Press.
- 19 Baxter, L.A. (2004). A tale of two voices: Relational Dialectics Theory. *The Journal of Family Communication*, 4 (3 & 4), 181-192. <https://doi.org/10.1080/15267431.2004.9670130>
- 20 Griffin, E.M. (2009). *A first look at communication theory*. McGraw Hill, pg. 115.
- 21 Baxter, L. A., & Montgomery, B. M. (1996). *Relating: Dialogues and dialectics*. Guilford Press.
- 22 Baxter, L. A. (2006). *Relationship dialectics theory: Multivocal dialogues of family communication*. In D. O. Braithwaite & L. A. Baxter (Eds.). *Engaging in family communication*. (pp. 130-145). Sage.
- 23 Jourard, S. M. (1971). *The transparent self* (rev. ed.). Van Nostrand Reinhold; pg. 19.
- 24 Petronio, S. (1991). Communication boundary management perspective: A model of managing the disclosure of private information between marital couples. *Communication Theory*, 1(4), 311-332. <https://doi.org/10.1111/j.1468-2885.1991.tb00023.x>
- 25 Petronio, S. (1991). Communication boundary management perspective: A model of managing the disclosure of private information between marital couples. *Communication Theory*, 1(4), 311-332. <https://doi.org/10.1111/j.1468-2885.1991.tb00023.x>; pg. 317.

- 26 Rosenfeld, L. B. (2000). Overview of the ways privacy, secrecy, and disclosure are balanced in today's society. In S. Petronio (Ed.), *Balancing the secrets of private disclosures* (pp. 3-18). Lawrence Erlbaum Associates.
- 27 Bailey, B. L. (1989). *From Front Porch to Back Seat: Courtship in twentieth century America*. John Hopkins University Press.
- 28 Mongeau, P. A., Jacobsen, J., & Donnerstein, C. (2007). Defining dates and first date goals: Generalizing from undergraduates to single adults. *Communication Research*, 34(5), 526-547. <https://doi.org/10.1177/0093650207305235>
- 29 Ibid.; pg. 534.
- 30 Match.com. (2019). *2019 – singles in America codebook*. Retrieved from <https://www.singlesinamerica.com/2019-Singles-in-America-Codebook.pdf>
- 31 Abelson, R. P. (1976). Script processing in attitude formation and decision making. In J. S. Carroll & J. W. Payne (Eds.), *Cognition and social behavior* (pp. 33-45). Lawrence Erlbaum.
- 32 Ibid.; pg. 41.
- 33 Abelson, R. P. (1981). Psychological status of the script concept. *American Psychologist*, 36, 715-29.
- 34 Rose, S., & Frieze, I.H. (1993). Young singles' contemporary dating scripts. *Sex Roles*, 28, 499-509. <https://doi.org/10.1177/089124389003002006>; pg. 505.
- 35 Ibid.; pg. 505.
- 36 Claire, M., Serewicz, M., & Gale, E. (2008). First-date scripts: Gender roles, context, and relationship. *Sex Roles*, 58, 149-164. <https://doi.org/10.1007/s11199-007-9283-4>
- 37 Klinkenberg, D. (1994). Dating scripts of gay men and lesbians. *Journal of Homosexuality*, 26(4), 23-35. https://doi.org/10.1300/J082v26n04_02
- 38 Ibid.
- 39 Gilbert, G. L., Clark, M. D., & Anderson, M. L. (2012). Do deaf individuals' dating scripts follow the traditional sexual script? *Sexuality & Culture*, 16, 90-199. <https://doi.org/10.1007/s12119-011-9111-4>
- 40 La France, B. (2010). What verbal and nonverbal communication cues lead to sex? An analysis of the traditional sexual script. *Communication Quarterly*, 58(3), 297-318. <https://doi.org/10.1080/01463373.2010.503161>; pg. 298.
- 41 Edgar, T., & Fitzpatrick, M. A. (1993). Expectations for sexual interaction: A cognitive test of the sequencing of sexual communication behaviors. *Health Communication*, 5(4), 239-261. https://doi.org/10.1207/s15327027hc0504_1
- 42 Hendrick, C., & Hendrick, S. S. (1988). Lovers wear rose colored glasses. *Journal of Social and Personal Relationships*, 5, 161-183. <https://doi.org/10.1177/026540758800500203>
- 43 Lee, J. A. (1977). A typology of styles of loving. *Personality and Social Psychology Bulletin*, 3(2), 173-182. <https://doi.org/10.1177/014616727700300204>
- 44 Khaddouma, A., Gordon, K. C., & Bolden, J. (2015). Zen and the art of dating: Mindfulness, differentiation of self, and satisfaction in dating relationships. *Couple and Family Psychology: Research and Practice*, 4(1), 1-13. <https://doi.org/10.1037/cfp0000035>; pg. 2.
- 45 Ibid., pg. 2.
- 46 Reeder, H. M. (2005). Exploring male-female communication: Three lessons on gender. *Journal of School Health*, 75(3), 115-117. <https://doi.org/10.1111/j.1746-1561.2005.tb06653.x>
- 47 Gaur, S. P. (2006). Achieving inter-gender communication effectiveness in organizations. *The Journal of Business Perspective*, 10(2), 11-18. <https://doi.org/10.1177/097226290601000203>
- 48 Reeder, H. M. (2005). Exploring male-female communication: Three lessons on gender. *Journal of School Health*, 75(3), 115-117. <https://doi.org/10.1111/j.1746-1561.2005.tb06653.x>
- 49 Wood, J. T., & Inman, C. C. (1993). In a different mode: Masculine styles of communicating closeness. *Journal of Applied Communication Research*, 21(3), 279-295. <https://doi.org/10.1080/00909889309365372>
- 50 Bem, S. L. (1974). The measurement of psychological androgyny. *Journal of Consulting and Clinical Psychology*, 42(2), 155-162. <https://doi.org/10.1037/h0036215>
- 51 Choi, Y. S. M., Gray, H. M., & Ambady, N. (2005). The glimpsed world: Unintended communication and unintended perception. In R. R. Hassin, J. S. Uleman, & J. A. Bargh (Eds.) *The new unconscious* (pp. 309-333).

Oxford University Press.

52 Versalle, A., & McDowell, E. E. (2004-2005). The attitudes of men and women concerning gender differences in grief. *Omega: Journal of Death and Dying*, 50(1), 53-67. <https://doi.org/10.2190/R2TJ-6M4F-RHGD-C2MD>

53 Gamble, T. K., & Gamble, M. W. (2014). *Interpersonal communication: Building connections together*. Sage.

END OF CHAPTER QUIZ
ANSWER KEY

1) B 2) B 3) C 4) B 5)D







Image by [Gerd Altmann](#) from [Pixabay](#)

Chapter 9

Conflict in Relationships

Conflict is a normal and natural part of life. However, learning how to manage conflict in our interpersonal relationships is very important for long-term success in those relationships. This chapter is going to look at how conflict functions and provide several strategies for managing interpersonal conflict.

9.1 Understanding Conflict

LEARNING

OUTCOMES

1. Differentiate between the terms conflict, disagreement, and argument.
2. Explain two perspectives about the existence of conflict.
3. Define and explain the term “interpersonal conflict.”

For our purposes, it is necessary to differentiate a conflict from a disagreement.¹ A **disagreement** is a difference of opinion and often occurs during an **argument**, or a verbal exchange between two or more people who have differing opinions on a given subject or subjects. It’s important to realize that arguments

are not conflicts, but if they become verbally aggressive, they can quickly turn into conflicts. One factor that ultimately can help determine if an argument will escalate into a conflict is an individual's tolerance for disagreement. James McCroskey, along with his colleagues, initially defined **tolerance for disagreement** as whether an individual can openly discuss differing opinions without feeling personally attacked or confronted.^{2,3} People that have a high tolerance for disagreement can easily discuss opinions with pretty much anyone and realize that arguing is perfectly normal and, for some, even entertaining. People that have a low tolerance for disagreement feel personally attacked any time someone is perceived as devaluing their opinion. From an interpersonal perspective, understanding someone's tolerance for disagreement can help in deciding if arguments will be perceived as the other as attacks that could lead to verbally aggressive conflicts. However, not all conflict is necessarily verbally aggressive nor destructive.

The term "conflict" is actually very difficult to pin down. We could have an entire chapter where we just examined various definitions of the term. Simplistically, **conflict** is an interactive process occurring when conscious beings (individuals or groups) have opposing or incompatible actions, beliefs, goals, ideas, motives, needs, objectives, obligations resources and/or values. First, conflict is interactive and inherently communicative. Second, two or more people or even groups of people who can think must be involved. Lastly, there are a whole range of different areas where people can have opposing or incompatible opinions. For this generic definition, we provided a laundry list of different types of incompatibility that can exist between two or more individuals or groups. Is this list completely exhaustive? No. But we provided this list as a way of thinking about the more common types of issues that are raised when people engage in conflict. From this perspective, everything from a minor disagreement to a knock-down, drag-out fight would classify as a conflict.

The rest of this section is going to explore the nature of conflict and its importance in communication. To do this, we'll discuss two different perspectives on conflict (disruption vs. normalcy). Then we'll explore interpersonal conflict more closely. Lastly, we'll discuss the positive and negative functions of conflict.

Two Perspectives on Conflict

As with most areas of interpersonal communication, no single perspective exists in the field related to interpersonal conflict. There are generally two very different perspectives that one can take. Herbert W. Simmons was one of the first to realize that there were two very different perspectives on conflict.⁴ On the one hand, you had scholars who see conflict as a disruption in a normal working system, which should be avoided. On the other hand, some scholars view conflict as a normal part of human relationships. Let's look at each of these in this section.

Disruptions in Normal Workings of a System

The first major perspective of conflict was proposed by James C. McCroskey and Lawrence R. Wheelless.⁵ McCroskey and Wheelless described conflict as a negative phenomenon in interpersonal relationships:

Conflict between people can be viewed as the opposite or antithesis of affinity. In this sense, interpersonal conflict is the breaking down of attraction and the development of repulsion, the dissolution of perceived homophily (similarity) and the increased perception of incompatible differences, the loss of perceptions of credibility and the development of disrespect.⁶

From this perspective, conflict is something inherently destructive. McCroskey and Virginia P. Richmond went further and argued that conflict is characterized by antagonism, distrust, hostility, and suspicion.⁷

This more negative view of conflict differentiates itself from a separate term, **disagreement**, which is simply a difference of opinion between two or more people or groups of people. Richmond and McCroskey note that there are two types of disagreements: substantive and procedural.⁸ A **substantive disagreement** is a disagreement that people have about a specific topic or issue. Basically, if you and your best friend want to go eat at two different restaurants for dinner, then you're engaging in a substantive disagreement. On the other hand, **procedural disagreements** are "concerned with procedure, how a decision should be reached or how a policy should be implemented."⁹ So, if your disagreement about restaurant choice switches to a disagreement on how to make a choice (flipping a coin vs. rock-paper-scissors), then you've switched into a procedural disagreement.

A conflict then is a disagreement plus negative affect, or when you disagree with someone else and you don't like the other person. It's the combination of a disagreement and dislike that causes a mere disagreement to turn into a conflict. Ultimately, conflict is a product of how one communicates this dislike of another person during the disagreement. People in some relationships end up saying very nasty things to one another during a disagreement because their affinity for the other person has diminished. When conflict is allowed to continue and escalate, it "can be likened to an ugly, putrid, decaying, pus-filled sore."¹⁰

From this perspective, conflicts are ultimately only manageable; whereas, disagreements can be solved. Although a disagreement is the cornerstone of all conflicts, most disagreements don't turn into conflicts because there is an affinity between the two people engaged in the disagreement.

Normal Part of Human Communication

The second perspective of the concept of conflict is very different from the first one. As described by Dudley D. Cahn and Ruth Anna Abigail, conflict is a normal, inevitable part of life.¹¹ Cahn and Abigail argue that conflict is one of the foundational building blocks of interpersonal relationships. One can even ask if it's possible to grow in a relationship without conflict. Managing and overcoming conflict makes a relationship stronger and healthier. Ideally, when interpersonal couples engage in conflict management (or conflict resolution), they will reach a solution that is mutually beneficial for both parties. In this manner, conflict can help people seek better, healthier outcomes within their interactions.

Ultimately, conflict is neither good nor bad, but it's a tool that can be used for constructive or destructive purposes. Conflict can be very beneficial and healthy for a relationship. Let's look at how conflict is beneficial for individuals and relationships:

- Conflict helps people find common ground.
- Conflict helps people learn how to manage conflict more effectively for the future.
- Conflict provides the opportunity to learn about the other person(s).
- Conflict can lead to creative solutions to problems.
- Confronting conflict allows people to engage in an open and honest discussion, which can build relationship trust.
- Conflict encourages people to grow both as humans and in their communication skills.
- Conflict can help people become more assertive and less aggressive.
- Conflict can strengthen individuals' ability to manage their emotions.

- Conflict lets individuals set limits in relationships.
- Conflict lets us practice our communication skills.

When one approaches conflict from this vantage point, conflict can be seen as an amazing resource in interpersonal relationships. However, both parties must agree to engage in prosocial conflict management strategies for this to work effectively (more on that later in this chapter).

Now that we've examined the basic idea of conflict, let's switch gears and examine conflict in a more interpersonal manner.

Interpersonal Conflict

According to Cahn and Abigail, interpersonal conflict requires four factors to be present:

1. the conflict parties are interdependent,
2. they have the perception that they seek incompatible goals or outcomes or they favor incompatible means to the same ends,
3. the perceived incompatibility has the potential to adversely affect the relationship leaving emotional residues if not addressed, and
4. there is a sense of urgency about the need to resolve the difference.¹²

Let's look at each of these parts of interpersonal conflict separately.

People are Interdependent

According to Cahn and Abigail, “**interdependence** occurs when those involved in a relationship characterize it as continuous and important, making it worth the effort to maintain.”¹³ From this perspective, interpersonal conflict occurs when we are in some kind of relationship with another person. For example, it could be a relationship with a parent/guardian, a child, a coworker, a boss, a spouse, etc. In each of these interpersonal relationships, we generally see ourselves as having long-term relationships with these people that we want to succeed. Notice, though, that if you're arguing with a random person on a subway, that will not fall into this definition because of the interdependence factor. We may have disagreements and arguments with all kinds of strangers, but those don't rise to the level of interpersonal conflicts.

People Perceive Differing Goals/Outcomes of Means to the Same Ends

An incompatible goal occurs when two people want different things. For example, imagine you and your best friend are thinking about going to the movies. They want to see a big-budget superhero film, and you're more in the mood for an independent artsy film. In this case, you have pretty incompatible goals (movie choices). You can also have incompatible means to reach the same end. Incompatible means, in this case, “occur when we want to achieve the same goal but differ in how we should do so.”¹⁴ For example, you and your best friend agree on going to the same movie, but not about at which theatre you should see the film.

Conflict Can Negatively Affect the Relationship if Not Addressed

Next, interpersonal conflicts can lead to very negative outcomes if the conflicts are not managed effective-

ly. Here are some examples of conflicts that are not managed effectively:

- One partner dominates the conflict, and the other partner caves-in.
- One partner yells or belittles the other partner.
- One partner uses half-truths or lies to get her/his/their way during the conflict.
- Both partners only want to get their way at all costs.
- One partner refuses to engage in conflict.
- Etc.

Again, this is a sample laundry list of some of the ways where conflict can be mismanaged. When conflict is mismanaged, one or both partners can start to have less affinity for the other partner, which can lead to a decreasing in liking, decreased caring about the relational partner, increased desire to exit the relationship, increased relational apathy, increased revenge-seeking behavior, etc. All of these negative outcomes could ultimately lead to conflicts becoming increasingly more aggressive (both active and passive) or just outright conflict avoidance. We'll look at both of these later in the chapter.

Some Sense of Urgency to Resolve Conflict

Lastly, there must be some sense of urgency to resolve the conflict within the relationship. The conflict gets to the point where it must receive attention, and a decision must be made or an outcome decided upon, or else. If a conflict reaches the point where it's not solved, then the conflict could become more problematic and negative if it's not dealt with urgently.

Now, some people let conflicts stir and rise over many years that can eventually boil over, but these types of conflicts when they arise generally have some other kind of underlying conflict that is causing the sudden explosion. For example, imagine your spouse has a particularly quirky habit. For the most part, you ignore this habit and may even make a joke about the habit. Finally, one day you just explode and demand the habit must change. Now, it's possible that you let this conflict build for so long that it finally explodes. It's kind of like a geyser. According to Yellowstone National Park, here's how a geyser works:

The looping chambers trap steam from the hot water. Escaped bubbles from trapped steam heat the water column to the boiling point. When the pressure from the trapped steam builds enough, it blasts, releasing the pressure. As the entire water column boils out of the ground, more than half the volume is this steam.

The eruption stops when the water cools below the boiling point.¹⁵

In the same way, sometimes people let irritations or underlying conflict percolate inside of them until they reach a boiling point, which leads to the eventual release of pressure in the form of a sudden, out of nowhere conflict. In this case, even though the conflict has been building for some time, the eventual desire to make this conflict known to the other person does cause an immediate sense of urgency for the conflict to be solved.

Key Takeaways

- The terms disagreement and argument are often confused with one another. For our purposes, the terms refer to unique concepts. A disagreement is a difference of opinion between two or more people or groups of people; whereas, an argument is a verbal exchange between two or more people who have differing opinions on

- a given subject or subjects.
- There are two general perspectives regarding the nature of conflict. The first perspective sees conflict as a disruption to normal working systems, so conflict is inherently something that is dangerous to relationships and should be avoided. The second perspective sees conflict as a normal, inevitable part of any relationship. From this perspective, conflict is a tool that can either be used constructively or destructively in relationships.
 - According to Cahn and Abigail, interpersonal conflict consists of four unique parts: 1) interdependence between or among the conflict parties, (2) incompatible goals/means, (3) conflict can adversely affect a relationship if not handled effectively, and (4) there is a sense of urgency to resolve the conflict.

Exercises

- On a sheet of paper, write out what you believe are the pros and cons of both major perspectives about conflict. Which one do you think describes your own understanding of conflict? Do you think they are both applicable to interpersonal conflict?
- Think of a time when you've engaged in conflict with a relational partner of some kind (parent/guardian, child, sibling, spouse, friend, romantic partner, etc.). Using Cahn and Abigail's four parts of interpersonal conflict, dissect the conflict and explain why it would qualify as an interpersonal conflict.
- We know that different people have different levels of tolerance for disagreement in life. How do you think an individual's tolerance for disagreement impacts her/his/their ability to interact with others interpersonally?

9.2 Emotions and Feelings

LEARNING OUTCOMES

1. Explain the interrelationships among emotions and feelings.
2. Describe emotional awareness and its importance to interpersonal communication.
3. Differentiate between "I" and "You" statements.
4. Explain the concept of emotional intelligence.

To start our examination of the idea of emotions and feelings and how they relate to harmony and discord in a relationship, it's important to differentiate between emotions and feelings. **Emotions** are our reactions to stimuli in the outside environment. Emotions, therefore, can be objectively measured by blood flow, brain activity, and nonverbal reactions to things. **Feelings**, on the other hand, are the responses to thoughts and interpretations given to emotions based on experiences, memory, expectations, and personality. So, there is an inherent relationship between emotions and feelings, but we do differentiate between them. Table 9.1 breaks down the differences between the two concepts.

Feelings:	Emotions:
Feelings tell us “ how to live. ”	Emotions tell us what we “ like ” and “ dis-like. ”
Feelings state: “There is a right and wrong way to be.”	Emotions state: “There are good and bad actions.”
Feelings state: “ your emotions matter. ”	Emotions state: “ The external world matters. ”
Feelings establish our long-term attitude toward reality.	Emotions establish our initial attitude toward reality.
Feelings alert us to anticipated dangers and prepares us for action.	Emotions alert us to immediate dangers and prepare us for action.
Feelings ensure long-term survival of self (body and mind).	Emotions ensure immediate survival of self (body and mind).
Feelings are Low-key but Sustainable.	Emotions are Intense but Temporary.
Happiness: is a feeling.	Joy: is an emotion.
Worry: is a feeling.	Fear: is an emotion.
Contentment: is a feeling.	Enthusiasm: is an emotion.
Bitterness: is a feeling.	Anger: is an emotion.
Love: is a feeling.	Lust: is an emotion.
Depression: is a feeling.	Sadness: is an emotion.

© John W. Voris, CEO of Authentic Systems, www.authentic-systems.com

Reprinted here with permission.

Table 9.1 The Differences of Emotions and Feelings

It’s important to understand that we are all allowed to be emotional beings. Being emotional is an inherent part of being a human. For this reason, it’s important to avoid phrases like “don’t feel that way” or “they have no right to feel that way.” Again, our emotions are our emotions, and, when we negate someone else’s emotions, we are negating that person as an individual and taking away their right to emotional responses. At the same time, though, no one else can make you “feel” a specific way. Our emotions are our emotions. They are how we interpret and cope with life. A person may set up a context where you experience an emotion, but you are the one who is still experiencing that emotion and allowing yourself to experience that emotion. If you don’t like “feeling” a specific way, then change it. We all have the ability to alter our emotions. Altering our emotional states (in a proactive way) is how we get through life. Maybe you just broke up with someone, and listening to music helps you work through the

grief you are experiencing to get to a better place. For others, they need to openly communicate about how they are feeling in an effort to process and work through emotions. The worst thing a person can do is attempt to deny that the emotion exists.

Think of this like a balloon. With each breath of air you blow into the balloon, you are bottling up more and more emotions. Eventually, that balloon will get to a point where it cannot handle any more air in it before it explodes. Humans can be the same way with emotions when we bottle them up inside. The final breath of air in our emotional balloon doesn't have to be big or intense. However, it can still cause tremendous emotional outpouring that is often very damaging to the person and their interpersonal relationships with others.

Other research has demonstrated that handling negative emotions during conflicts within a marriage (especially on the part of the wife) can lead to faster de-escalations of conflicts and faster conflict mediation between spouses.¹⁶

Emotional Awareness

Sadly, many people are just completely unaware of their own emotions. **Emotional awareness**, or an individual's ability to clearly express, in words, what they are feeling and why, is an extremely important factor in effective interpersonal communication. Unfortunately, our emotional vocabulary is often quite limited. One extreme version of not having an emotional vocabulary is called **alexithymia**, "a general deficit in emotional vocabulary—the ability to identify emotional feelings, differentiate emotional states from physical sensations, communicate feelings to others, and process emotion in a meaningful way."¹⁷ Furthermore, there are many people who can accurately differentiate emotional states but lack the actual vocabulary for a wide range of different emotions. For some people, their emotional vocabulary may consist of good, bad, angry, and fine. Learning how to communicate one's emotions is very important for effective interpersonal relationships.¹⁸ First, it's important to distinguish between our emotional states and how we interpret an emotional state. For example, you can feel sad or depressed, but you really cannot feel alienated. Your sadness and depression may lead you to perceive yourself as alienated, but alienation is a perception of one's self and not an actual emotional state. There are several evaluative terms that people ascribe themselves (usually in the process of blaming others for their feelings) that they label emotions, but which are in actuality evaluations and not emotions. Table 9.2 presents a list of common evaluative words that people confuse for emotional states.

Abandoned	Cornered	Mistreated	Scorned
Abused	Devalued	Misunderstood	Taken for granted
Affronted	Diminished	Neglected	Threatened
Alienated	Distrusted	Overworked	Thwarted
Attacked	Humiliated	Patronized	Tortured
Belittled	Injured	Pressured	Unappreciated
Betrayed	Interrupted	Provoked	Unheard
Boxed-in	Intimidated	Put away	Unseen
Bullied	Let down	Putdown	Unsupported
Cheated	Maligned	Rejected	Unwanted
Coerced	Manipulated	Ridiculed	Used
Co-opted	Mocked	Ruined	Wounded

Table 9.2 Evaluative Words Confused for Emotions

Instead, people need to avoid these evaluative words and learn how to communicate effectively using a wide range of emotions. Tables 9.3 and 9.4 provide a list of both positive and negative feelings that people can express. Go through the list considering the power of each emotion. Do you associate light, medium, or strong emotions with the words provided on these lists? Why? There is no right or wrong way to answer this question. Still, it is important to understand that people can differ in their interpretations of the strength of different emotionally laden words. If you don't know what a word means, you should look it up and add another word to your list of feelings that you can express to others.

Absorbed	Eager	Happy	Rapturous
Adventurous	Ebullient	Helpful	Refreshed
Affectionate	Ecstatic	Hopeful	Relaxed
Aglow	Effervescent	Inquisitive	Relieved
Alert	Elated	Inspired	Sanguine
Alive	Enchanted	Intense	Satisfied
Amazed	Encouraged	Interested	Secure
Amused	Energetic	Intrigued	Sensitive
Animated	Engrossed	Invigorated	Serene
Appreciative	Enlivened	Involved	Spellbound
Ardent	Enthusiastic	Jovial	Splendid
Aroused	Euphoric	Joyous	Stimulated
Astonished	Excited	Jubilant	Sunny
Blissful	Exhilarated	Keyed-up	Surprised
Breathless	Expansive	Lively	Tender
Buoyant	Expectant	Loving	Thankful
Calm	Exultant	Mellow	Thrilled
Carefree	Fascinated	Merry	Tickled Pink
Cheerful	Free	Mirthful	Touched
Comfortable	Friendly	Moved	Tranquil
Complacent	Fulfilled	Optimistic	Trusting
Composed	Genial	Overwhelmed	Upbeat
Concerned	Glad	Peaceful	Vibrant
Confident	Gleeful	Perky	Warm
Content	Glorious	Pleasant	Wonderful
Cool	Glowing	Pleased	Zippy
Curious	Good-humored	Proud	
Dazzled	Grateful	Quiet	
Delighted	Gratified	Radiant	

Table 9.3 Positive Emotions

Afraid	Disgusted	Impatient	Sensitive
Aggravated	Disheartened	Indifferent	Shaky

Agitated	Dismayed	Intense	Shameful
Alarmed	Displeased	Irate	Shocked
Angry	Disquieted	Irked	Skeptical
Anguished	Disturbed	Irritated	Sleepy
Annoyed	Distressed	Jealous	Sorrowful
Antagonistic	Downcast	Jittery	Sorry
Anxious	Downhearted	Keyed-up	Spiritless
Apathetic	Dull	Lazy	Spiteful
Appalled	Edgy	Leery	Startled
Apprehensive	Embarrassed	Lethargic	Sullen
Aroused	Embittered	Listless	Surprised
Ashamed	Exasperated	Lonely	Suspicious
Beat	Exhausted	Mad	Tearful
Bewildered	Fatigued	Mean	Tepid
Bitter	Fearful	Melancholy	Terrified
Blah	Fidgety	Miserable	Ticked off
Blue	Forlorn	Mopey	Tired
Bored	Frightened	Morose	Troubled
Brokenhearted	Frustrated	Mournful	Uncomfortable
Chagrined	Furious	Nervous	Unconcerned
Cold	Galled	Nettled	Uneasy
Concerned	Gloomy	Numb	Unglued
Confused	Grim	Overwhelmed	Unhappy
Cool	Grouchy	Panicky	Unnerved
Crabby	Guilty	Passive	Unsteady
Cranky	Harried	Perplexed	Upset
Cross	Heavy	Pessimistic	Uptight
Dejected	Helpless	Petulant	Vexed
Depressed	Hesitant	Puzzled	Weary
Despairing	Hopeless	Rancorous	Weepy
Despondent	Horrificed	Reluctant	Wistful
Detached	Horrible	Repelled	Withdrawn
Disaffected	Hostile	Resentful	Woeful
Disenchanted	Hot	Restless	Worried
Disappointed	Humdrum	Sad	Wretched
Discouraged	Hurt	Scared	Sensitive
Disgruntled	Ill-Tempered	Seething	Shaky

Table 9.4 Negative Emotions

The Problem of You Statements

According to Marshall Rosenberg, the father of nonviolent communication, “You” statements ultimately

are moralistic judgments where we imply the wrongness or badness of another person and the way they have behaved.¹⁹ When we make moralistic judgments about others, we tend to deny responsibility for our thoughts, feelings, and behaviors. Remember, when it comes to feelings, no one can “make” you feel a specific way. We choose the feelings we inhabit; we do not inhabit the feelings that choose us. When we make moralistic judgments and deny responsibility, we end up in a constant cycle of defensiveness where your individual needs are not going to be met by your relational partner. Behind every negative emotion is a need not being fulfilled, and when we start blaming others, those needs will keep getting unfilled in the process. Often this lack of need fulfillment will result in us demanding someone fulfill our need or face blame or punishment. For example, “if you go hang out with your friends tonight, I’m going to hurt myself and it will your fault.” In this simple sentence, we see someone who disapproves of another’s behaviors and threatens to blame their relational partner for the individual’s behavior. In highly volatile relationships, this constant blame cycle can become very detrimental, and no one’s needs are getting met.

However, just observing behavior and stating how you feel only gets you part of the way there because you’re still not describing your need. Now, when we talk about the idea of “needing” something, we are not talking about this strictly in terms of Maslow’s Hierarchy of Needs, though those are all entirely appropriate needs. At the same time, relational needs are generally not rewards like tangible items or money. Instead, Marshall Rosenberg categorizes basic needs that we all have falling into the categories: autonomy, celebration, play, spiritual communion, physical nurturance, integrity, and interdependence (Table 9.5). As you can imagine, any time these needs are not being met, you will reach out to get them fulfilled. As such, when we communicate about our feelings, they are generally tied to an unmet or fulfilled need. For example, you could say, “I feel dejected when you yell at me because I need to be respected.” In this sentence, you are identifying your need, observing the behavior, and labeling the need. Notice that there isn’t judgment associated with identifying one’s needs.

Autonomy	Integrity
· to choose one’s dreams, goals, values	· authenticity
· to choose one’s plan for fulfilling one’s dreams, goals, values	· creativity
Celebration	· meaning
· to celebrate the creation of life and dreams fulfilled	· self-worth
· to celebrate losses: loved ones, dreams, etc. (mourning)	Interdependence
Play	· acceptance
· fun	· appreciation
· laughter	· closeness
Spiritual Communion	· community
· beauty	· consideration
· harmony	· contribution to the enrichment of life (to exercise one’s power by giving that which contributes to life)

· inspiration	· emotional safety
· order	· empathy
· peace	· honesty (the empowering honest that enables us to learn from our limitations)
Physical Nurturance	· love
· air	· reassurance
· food	· respect
· movement, exercise	· support
· protection from life-threatening forms of life: viruses, bacteria, insects, predatory animals	· trust
· rest	· understanding
· sexual expression	· warmth
· shelter	Table 9.6 Emotional Intelligence Questionnaire
· touch	
· water	

Source: Nonviolent Communication: A Language of Life 2nd Ed by Dr. Marshall B. Rosenberg, 2003—published by PuddleDancer Press and Used with Permission.

For more information visit www.CNVC.org and www.NonviolentCommunication.com

Table 9.5 Needs

Emotional Intelligence

In Chapter 3, we first discussed the concept of emotional intelligence. However, it's important to revisit this concept before we move on. In Chapter 3, we defined **emotional intelligence (EQ)** as an individual's appraisal and expression of their emotions and the emotions of others in a manner that enhances thought, living, and communicative interactions. Furthermore, we learned that EQ is built by four distinct emotional processes: perceiving, understanding, managing, and using emotions.²⁰ Although we are talking about the importance of EQ, take a minute and complete Table 9.6, which is a simple 20-item questionnaire designed to help you evaluate your own EQ.

Research Spotlight



In 2020, researchers Anna Wollny, Ingo Jacobs, and Luise Pabel set out to examine the impact that trait EQ has on both relationship satisfaction and dyadic coping. Dyadic coping is based on Guy Bodenmann's Systemic Transactional Model (STM), which predicts that stress in dyadic relationships is felt by both partners.²¹ So, if one partner experiences the stress of a job loss, that stress really impacts both partners. As a result, both partners can engage in mutual shared problem-solving or joint emotion-regulation.²² According to Bodenmann, there are three different common forms of dyadic coping:

Instructions: Read the following questions and select the answer that corresponds with your perception. Do not be concerned if some of the items appear similar. Please use the scale below to rate the degree to which each statement applies to you.

Strongly Disagree 1	Disagree 2	Neutral 3	Agree 4	Strongly Agree 5
-------------------------------	----------------------	---------------------	-------------------	----------------------------

1. I am aware of my emotions as I experience them.
2. I easily recognize my emotions.
3. I can tell how others are feeling simply by watching their body movements.
4. I can tell how others are feeling by listening to their voices.
5. When I look at people's faces, I generally know how they are feeling.
6. When my emotions change, I know why.
7. I understand that my emotional state is rarely comprised of one single emotion.
8. When I am experiencing an emotion, I have no problem easily labeling that emotion.
9. It's completely possible to experience two opposite emotions at the same time (e.g., love & hate; awe & fear; joy & sadness).
10. I can generally tell when my emotional state is shifting from one emotion to another.
11. I don't let my emotions get the best of me.
12. I have control over my own emotions.
13. I can analyze my emotions and determine if they are reasonable or not.
14. I can engage or detach from an emotion depending on whether I find it informative or useful.
15. When I'm feeling sad, I know how to seek out activities that will make me happy.
16. I can create situations that will cause others to experience specific emotions.
17. I can use my understanding of emotions to have more productive interactions with others.
18. I know how to make other people happy or sad.
19. I often lift people's spirits when they are feeling down.
20. I know how to generate negative emotions and enhance pleasant ones in my interactions with others.

Scoring

Understanding Emotions Add scores for items 6, 7, 8, 9, & 10 = _____

Managing Emotions Add scores for items 11, 12, 13, 14, & 15 = _____

Using Emotions Add scores for items 16, 17, 18, 19, & 20 = _____

Interpretation

Each of the four parts of the EQ Model can have a range of 5 to 25. Scores under 11 represent low levels of EQ for each aspect. Scores between 12 and 18 represent average levels of EQ. Scores 19 and higher represent high levels of EQ.

Table 9.6 Emotional Intelligence Questionnaire

1. Positive dyadic coping involves the provision of problem- and emotion-focused support and reducing the partner's stress by a new division of responsibilities and contributions to the coping process.
2. Common dyadic coping (i.e., joint dyadic coping) includes strategies in which both partners jointly engage to reduce stress (e.g., exchange tenderness, joint problem-solving).
3. Negative dyadic coping comprises insufficient support and ambivalent or hostile intervention attempts (e.g., reluctant provision of support while believing that the partner should solve the problem alone).²³

In the Wollny et al. (2000) study, the researchers studied 136 heterosexual couples. Trait EQ was positively related to relationship satisfaction. Trait EQ was positively related to positive dyadic coping and common dyadic coping but not related to negative dyadic coping.

Wollny, A., Jacobs, I., & Pabel, L. (2020, 2020/01/02). Trait emotional intelligence and relationship satisfaction: The mediating role of dyadic coping. *The Journal of Psychology*, *154*(1), 75-93. <https://doi.org/10.1080/00223980.2019.1661343>

Letting Go of Negative Thoughts

We often refer to these negative thoughts as vulture statements (as discussed in Chapter 3).²⁴ Some of us have huge, gigantic vultures sitting on our shoulders every day, and we keep feeding them with all of our negative thoughts. Right when that thought enters your head, you have started to feed that vulture sitting on your shoulders.

Unfortunately, many of us will focus on that negative thought and keep that negative thought in our heads for a long period. It's like have a bag full of carrion, and we just keep lifting it to the vulture, who just keeps getting fatter and fatter, weighing you down more and more.

Every time we point out a negative thought instead of harping on that thought, we take a pause and stop feeding the vulture. Do this long enough, and you will see the benefits to your self-concept. Furthermore, when we have a healthy self-concept, we also have stronger interpersonal relationships.²⁵

Positive Emotions During Conflict

Researchers have found that serious relationship problems arise when those in the relationship are unable to reach beyond the immediate conflict and include positive as well as negative emotions in their discussions. In a landmark study of newlywed couples, for example, researchers attempted to predict who would have a happy marriage versus an unhappy marriage or a divorce, based on how the newlyweds

communicated with each other. Specifically, they created a stressful conflict situation for couples. The researchers then evaluated how many times the newlyweds expressed positive emotions and how many times they expressed negative emotions in talking with each other about the situation.

When the marital status and happiness of each couple were evaluated over the next six years, the study found that the strongest predictor of a marriage that stayed together and was happy was the degree of positive emotions expressed during the conflict situation in the initial interview.²⁶

In happy marriages, instead of always responding to anger with anger, the couples found a way to lighten the tension and to de-escalate the conflict. In long-lasting marriages, during stressful times or in the middle of conflict, couples were able to interject some positive comments and positive regard for each other. When this finding is generalized to other types of interpersonal relationships, it makes a strong case for having some positive interactions, interjecting some humor, some light-hearted fun, or some playfulness into your conversation while you are trying to resolve conflicts.

Key Takeaways

- Emotions are our physical reactions to stimuli in the outside environment; whereas, feelings are the responses to thoughts and interpretations given to emotions based on experiences, memory, expectations, and personality.
- Emotional awareness involves an individual's ability to recognize their feelings and communicate about them effectively. One of the common problems that some people have with regards to emotional awareness is a lack of a concrete emotional vocabulary for both positive and negative feelings. When people cannot adequately communicate about their feelings, they will never get what they need out of a relationship.
- One common problem in interpersonal communication is the overuse of "You" statements. "I" statements are statements that take responsibility for how one is feeling. "You" statements are statements that place the blame of one's feelings on another person. Remember, another person cannot make you feel a specific way. Furthermore, when we communicate "you" statements, people tend to become more defensive, which could escalate into conflict.
- Emotional intelligence is the degree to which an individual has the ability to perceive (recognizing emotions when they occur), understand (the ability to understand why emotions and feelings arise), communicate (articulating one's emotions and feelings to another person), and manage emotions and feelings (being able to use emotions effectively during interpersonal relationships).

Exercises

- Think of an extreme emotion you've felt recently. Explain the interrelationships between that emotion, your thoughts, and your feelings when you experienced that extreme emotion.
- Complete the Emotional Intelligence Questionnaire. What areas are your strengths with regard to EQ? What areas are your weaknesses? How can you go about improving your strengths while alleviating your weaknesses?

- Think of a conflict you've had with a significant other in your relationship. How many of the statements that were made during that conflict were "You" statements as compared to "I" statements? How could you have more clearly expressed your feelings and link them to your needs?

9.3 Power and Influence

LEARNING OUTCOMES

1. Define the term "influence" and explain the three levels of influence.
2. Define the word "power" and explain the six bases of power.

One of the primary reasons we engage in a variety of interpersonal relationships over our lifetimes is to influence others. We live in a world where we constantly need to accomplish a variety of goals, so being able to get others to jump on board with our goals is a very important part of social survival. As such, we define **influence** when an individual or group of people alters another person's thinking, feelings, and/or behaviors through accidental, expressive, or rhetorical communication.²⁷ Notice this definition of influence is one that focuses on the importance of communication within the interaction. Within this definition, we discuss three specific types of communication: accidental, expressive, or rhetorical.

First, we have accidental communication, or when we send messages to another person without realizing those messages are being sent. Imagine you are walking through your campus' food court and notice a table set up for a specific charity. A person who we really respect is hanging out at the table laughing and smiling, so you decide to donate a dollar to the charity. The person who was just hanging out at the table influenced your decision to donate. They could have just been talking to another friend and may not have even really been a supporter of the charity, but their presence was enough to influence your donation. At the same time, we often influence others to think, feel, and behave in ways they wouldn't have unconsciously. A smile, a frown, a head nod, or eye eversion can all be nonverbal indicators to other people, which could influence them. There's a great commercial on television that demonstrates this. The commercial starts with someone holding the door for another person, then this person turns around and does something kind to another person, and this "paying it forward" continues through the entire commercial. In each incident, no one said to the person they were helping to "pay it forward," they just did.

The second type of communication we can have is **expressive or emotionally-based communication**. Our emotional states can often influence other people. If we are happy, others can become happy, and if we are sad, others may avoid us altogether. Maybe you've walked into a room and seen someone crying, so you ask, "Are you OK?" Instead of responding, the person just turns and glowers at you, so you turn around and leave. With just one look, this person influenced your behavior.

The final type of communication, **rhetorical communication**, involves purposefully creating and sending messages to another person in the hopes of altering another person's thinking, feelings, and/or behaviors. Accidental communication is not planned. Expressive communication is often not conscious at all. However, rhetorical communication is purposeful. When we are using rhetorical communication to influence another person(s), we know that we are trying to influence that person(s).

Levels of Influence

In 1958 social psychologist Herbert Kelman first noted that there are three basic levels of influence: compliance, identification, and internalization.²⁸ Kelman's basic theory was that changes in a person's thoughts, feelings, and/or behaviors occur at different levels, which results in different processes an individual uses to achieve conformity with an influencer. Let's look at each of these three levels separately.

Compliance

The first, and weakest, form of influence is compliance. **Compliance** implies that an individual accepts influence and alters their thoughts, feelings, and/or behaviors. However, this change in thoughts, feelings, and/or behaviors is transitory and only lasts as long as the individual sees compliance as beneficial.²⁹ Generally, people accept influence at this level because they perceive the rewards or punishments for influence to be in their best interest. As such, this form of influence is very superficial.³⁰

Identification

The second form of influence discussed by Kelman is **identification**, which is based purely in the realm of relationships. Identification occurs when an individual accepts influence because they want to have a satisfying relationship with the influencer or influencing group. "The individual actually believes in the responses which he [or she] adopts through identification, but their specific content is more or less irrelevant. He [or she] adopts the induced behavior because it is associated with the desired relationship. Thus the satisfaction derived from identification due to the act of conforming as such."³¹ Notice that Kelman is arguing that the actual change to thoughts, feelings, and/or behaviors is less of an issue than the relationship and the act of conforming. However, if an individual ever decides that the relationship and identification with the influencing individual or group are not beneficial, then the influencing attempts will disappear, and the individual will naturally go back to their original thoughts, feelings, and/or behaviors.

Internalization

The final level of influence proposed by Kelman is **internalization**, which occurs when an individual adopts influence and alters their thinking, feeling, and/or behaviors because doing so is intrinsically rewarding. Ultimately, changing one's thinking, feelings, and/or behavior happens at the internalization level because an individual sees this change as either coinciding with their value system, considers the change useful, or fulfills a need the individual has. Influence that happens at this level becomes highly intertwined with the individual's perception of self, so this type of influence tends to be long-lasting.

French & Raven's Five Bases of Power

When you hear the word "power," what comes to mind? Maybe you think of a powerful person like a Superhero or the President of the United States. For social scientists, we use the word "power" in a very specific way. **Power** is the degree that a social agent (A) has the ability to get another person(s) (P) to alter their thoughts, feelings, and/or behaviors. First, you have a social agent (A), which can come in a variety of different forms: another person, a role someone embodies, a group rule or norm, or a group or part of a group.³² Next, we have the person(s) who is being influenced by the goal to be a specific change



Figure 9.1 French & Raven’s Five Bases of Power

Let’s examine each of these five bases of power.

Informational

The first basis of power is the last one originally proposed by Raven.³⁵ **Informational power** refers to a social agent’s ability to bring about a change in thought, feeling, and/or behavior through information. For example, since you initially started school, teachers have had informational power over you. They have provided you with a range of information on history, science, grammar, art, etc. that shape how you think (what constitutes history?), feel (what does it mean to be aesthetically pleasing?), and behave (how do you properly mix chemicals in a lab?). In some ways, informational power is very strong, because it’s often the first form of power with which we come into contact. In fact, when you are taught how to think, feel, and/or behave, this change “now continues without the target necessarily referring to, or even remembering, the [influencer] as being the agent of change.”³⁶

Coercive and Reward

The second base of power is **coercive power**, which is the ability to punish an individual who does not comply with one’s influencing attempts. On the other end of the spectrum, we have **reward power** (3rd base of power), which is the ability to offer an individual rewards for complying with one’s influencing attempts. We talk about these two bases of power together because they are two sides of the same coin. Furthermore, the same problems with this type of power apply equally to both. Influence can happen if you punish or reward someone; however, as soon as you take away that punishment or reward, the thoughts, feelings, and/or behavior will reverse back to its initial state. Hence, we refer to both coercive and reward power as attempts to get someone to comply with influence, because this is the highest level of influence one can hope to achieve with these two forms of power.

in thoughts, feelings, and/or behaviors. When we discussed influence above, we talked about it in terms of communication: accidental, expressive, and rhetorical. When we deal with power, we are only dealing in the realm of rhetorical communication because the person exerting power over another person is consciously goal-directed.

Probably the most important people in the realm of power have been John French and Bertram Raven. In 1959, French and Raven identified five unique bases of power that people can use to influence others (coercive, reward, legitimate, expert, and referent).³³ At the time of their original publication, there was a sixth base of power that Raven attempted to argue for, informational. Although he lost the battle in the initial publication, subsequent research by Raven on the subject of the bases of power have all included informational power.³⁴

Legitimate

The fourth base of power is **legitimate power**, or influence that occurs because a person (P) believes that the social agent (A) has a valid right to influence P, and P has an obligation to accept A's attempt to influence P's thoughts, feelings, and/or behaviors. French and Raven argued that there were two common forms of legitimate power: cultural and structural. Cultural legitimate power occurs when a change agent is viewed as having the right to influence others because of their role in the culture. For example, in some cultures, the elderly may have a stronger right to influence than younger members of that culture. Structural legitimate power, on the other hand, occurs because someone fulfills a specific position within the social hierarchy. For example, your boss may have the legitimate right to influence your thoughts, feelings, and/or behaviors in the workplace because they are above you in the organizational hierarchy.³⁷

Expert

The fifth base of power is **expert power**, or the power we give an individual to influence us because of their perceived knowledge. For example, we often give our physicians the ability to influence our behavior (e.g., eat right, exercise, take medication) because we view these individuals as having specialized knowledge. However, this type of influence only is effective if P believes A is an expert, P trusts A, and P believes that A is telling the truth.

One problem we often face in the 21st Century involves the conceptualization of the word “expert.” Many people in today's world can be perceived as “experts” just because they write a book, have a talk show, were on a reality TV show, or are seen on news programs.³⁸ Many of these so-called “experts” may have no reasonable skill or knowledge but they can be trumpeted as experts. One of the problems with the Internet is the fundamental flaw that anyone can put information online with only an opinion and no actual facts. Additionally, we often engage in debates about “facts” because we have different talking heads telling us different information. Historically, expert power was always a very strong form of power, but there is growing concern that we are losing expertise and knowledge to unsubstantiated opinions and rumor mongering.

At the same time, there is quite a bit of research demonstrating that many people are either unskilled or unknowledgeable and completely unaware of their lack of expertise. This problem has been called the **Dunning–Kruger effect**, or the tendency of some people to inflate their expertise when they really have nothing to back up that perception.³⁹ As you can imagine, having a lot of people who think they are experts spouting off information that is untrue can be highly problematic in society. For example, do you really want to take medical advice from a TV star? Many people do. While we have some people who inflate their expertise, on the other end of the spectrum, some people suffer from imposter syndrome, which occurs when people devalue or simply do not recognize their knowledge and skills. Imposter syndrome is generally a problem with highly educated people like doctors, lawyers, professors, business executives, etc. The fear is that someone will find out that they are a fraud.

Referent

The final base of power originally discussed by French and Raven is **referent power**, or a social agent's ability to influence another person because P wants to be associated with A. Ultimately, referent power is about relationship building and the desire for a relationship. If A is a person P finds attractive, then P will do whatever they need to do to become associated with A. If A belongs to a group, then P will want to join that group. Ultimately, this relationship exists because P wants to think, feel, and behave as A

does. For example, if A decides that he likes modern art, then P will also decide to like modern art. If A has a very strong work ethic in the workplace, then P will adopt a strong work ethic in the workplace as well. Often A has no idea of the influence they are having over P. Ultimately, the stronger P desires to be associated with A, the more referent power A has over P.

Influence and Power

By now, you may be wondering about the relationship between influence and power. Research has examined the relationship between the three levels of influence and the six bases of power. Coercive, reward, and legitimate power only influence people at the compliance level. Whereas, informational, expert, and referent power have been shown to influence people at all three levels of influence: compliance, identification, and internalization.⁴⁰ When you think about your own interpersonal influencing goals, you really need to consider what level of influence you desire a person's change in thoughts, feelings, and/or behaviors to be. If your goal is just to get the change quickly, then using coercive, reward, and legitimate power may be the best route. If, however, you want to ensure long-term influence, then using informational, expert, and referent power are probably the best routes to use.

Research Spotlight



In 2013, Shireen Abuhatum and Nina Howe set out to explore how siblings use French and Raven's bases of power in their relationships. Specifically, they examined how older siblings (average age of 7 years old) interacted with their younger siblings (average age was 4 ½ years old). Sibling pairs were recorded playing at home with a wooden farm set that was provided for the observational study. Each recorded video lasted for 15-minutes. The researchers then coded the children's verbal and nonverbal behaviors. The goal was to see what types of power strategies the siblings employed while playing.

Unsurprisingly, older siblings were more likely to engage in power displays with their younger siblings to get what they wanted. However, younger siblings were more likely to appeal to a third party (usually an adult) to get their way.

The researchers also noted that when it came to getting a desired piece of the farm to play with, older siblings were more likely to use coercive power. Younger siblings were more likely to employ legitimate power as an attempt to achieve a compromise.

Abuhatum, S., & Howe, N. (2013). Power in sibling conflict during early and middle childhood. *Social Development, 22*(4), 738-754. <https://doi.org/10.1111/sode.12021>

Key Takeaways

- Herbert Kelman noted that there are three basic levels of influence: compliance (getting someone to alter behavior), identification (altering someone's behavior because they want to be identified with a person or group), and internalization (influence that occurs because someone wants to be in a relationship with an influencer).
- French and Raven have devised six basic bases of power: informational, coercive, reward, legitimate, expert, and referent. First, we have informational power, or

the power we have over others as we provide them knowledge. Second, we have coercive power, or the ability to punish someone for noncompliance. Third, we have reward power, or the ability to reward someone for compliance. Fourth we have legitimate power, or power someone has because of their position within a culture or a hierarchical structure. Fifth, we have expert power, or power that someone exerts because they are perceived as having specific knowledge or skills. Lastly, we have referent power, or power that occurs because an individual wants to be associated with another person.

Exercises

- Think of a time when you've been influenced at all three of **Kelman's** levels of influence. How were each of these situations of influence different from each other? How were the different levels of influence achieved?
- Think of each of the following situations and which form of power would best be used and why:
 - A mother wants her child to eat his vegetables.
 - A police officer wants to influence people to slow down in residential neighborhoods.
 - The Surgeon General of the United States wants people to become more aware of the problems of transsaturated fats in their diets.
 - A friend wants to influence his best friend to stop doing drugs.

9.4 Conflict Management Strategies

LEARNING OUTCOMES

1. Differentiate between conflict and disagreement.
2. Explain the three common styles of conflict management.
3. Summarize the STLC Model of Conflict.

Many researchers have attempted to understand how humans handle conflict with one another. The first researchers to create a taxonomy for understanding conflict management strategies were **Richard E. Walton** and **Robert B. McKersie**.⁴¹ Walton and McKersie were primarily interested in how individuals handle conflict during labor negotiations. The Walton and McKersie model consisted of only two methods for managing conflict: integrative and distributive. **Integrative conflict** is a win-win approach to conflict; whereby, both parties attempt to come to a settled agreement that is mutually beneficial. **Distributive conflict** is a win-lose approach; whereby, conflicting parties see their job as to win and make sure the other person or group loses. Most professional schools teach that integrative negotiation tactics are generally the best ones.

ABC's of Conflict

Instructions: Read the following questions and select the answer that corresponds with how you typically behave when engaged in conflict with another person. Do not be concerned if some of the items appear similar. Please use the scale below to rate the degree to which each statement applies to you.

Strongly Disagree 1	Disagree 2	Neutral 3	Agree 4	Strongly Agree 5
-------------------------------	----------------------	---------------------	-------------------	----------------------------

When I start to engage in a conflict, I _____

- _____ 1. Keep the conflict to myself to avoid rocking the boat.
- _____ 2. Do my best to win.
- _____ 3. Try to find a solution that works for everyone.
- _____ 4. Do my best to stay away from disagreements that arise.
- _____ 5. Create a strategy to ensure my successful outcome.
- _____ 6. Try to find a solution that is beneficial for those involved.
- _____ 7. Avoid the individual with whom I'm having the conflict.
- _____ 8. Won't back down unless I get what I want.
- _____ 9. Collaborate with others to find an outcome OK for everyone.
- _____ 10. Leave the room to avoid dealing with the issue.
- _____ 11. Take no prisoners.
- _____ 12. Find solutions that satisfy everyone's expectations.
- _____ 13. Shut down and shut up in order to get it over with as quickly as possible.
- _____ 14. See it as an opportunity to get what I want.
- _____ 15. Try to integrate everyone's ideas to come up with the best solution for everyone.
- _____ 16. Keep my disagreements to myself.
- _____ 17. Don't let up until I win.
- _____ 18. Openly raise everyone's concerns to ensure the best outcome possible.

Scoring

Avoiders	Add scores for items 1, 4, 7, 10, 13, & 16	= _____
Battlers	Add scores for items 2, 5, 8, 11, 14, & 17	= _____
Collaborators	Add scores for items 3, 6, 9, 12, 15, & 18	= _____

Interpretation

Each of the four parts of the EQ Model can have a range of 5 to 25. Scores under 11 represent low levels of EQ for each aspect. Scores between 12 and 18 represent average levels of EQ. Scores 19 and higher represent high levels of EQ.

Table 9.6 Emotional Intelligence Questionnaire

Over the years, a number of different patterns for handling conflict have arisen in the literature, but most of them agree with the first two proposed by Walton and McKersie, but they generally add a third dimension of conflict: **avoidance**. Go ahead and take a moment to complete the questionnaire in Table 7.

Avoiders

Alan Sillars, Stephen, Coletti, Doug Parry, and Mark Rogers created a taxonomy of different types of strategies that people can use when avoiding conflict. Table 9.8 provides a list of these common tactics.⁴²



Conflict Management Tactic	Definition	Example
Simple Denial	Statements that deny the conflict.	“No, I’m perfectly fine.”
Extended Denial	Statements that deny conflict with a short justification.	“No, I’m perfectly fine. I just had a long night.”
Underresponsiveness	Statements that deny the conflict and then pose a question to the conflict partner.	“I don’t know why you are upset, did you wake up on the wrong side of the bed this morning?”

Topic Shifting	Statements that shift the interaction away from the conflict.	“Sorry to hear that. Did you hear about the mall opening?”
Topic Avoidance	Statements designed to clearly stop the conflict.	“I don’t want to deal with this right now.”
Abstractness	Statements designed to shift a conflict from concrete factors to more abstract ones.	“Yes, I know I’m late. But what is time really except a construction of humans to force conformity.”
Semantic Focus	Statements focused on the denotative and connotative definitions of words.	“So, what do you mean by the word ‘sex’?”
Process Focus	Statements focused on the “appropriate” procedures for handling conflict.	“I refuse to talk to you when you are angry.”
Joking	Humorous statements designed to derail conflict.	“That’s about as useless as a football bat.”
Ambivalence	Statements designed to indicate a lack of caring.	“Whatever!” “Just do what you want.”
Pessimism	Statements that devalue the purpose of conflict.	“What’s the point of fighting over this? Neither of us are changing our minds.”
Evasion	Statements designed to shift the focus of the conflict.	“I hear the Joneses down the street have that problem, not us.”
Stalling	Statements designed to shift the conflict to another time.	“I don’t have time to talk about this right now.”
Irrelevant Remark	Statements that have nothing to do with the conflict.	“I never knew the wallpaper in here had flowers on it.”

Table 9.8 Avoidant Conflict Management Strategies

Battlers

For our purposes, we have opted to describe those who engage in distributive conflict as battlers because they often see going into a conflict as heading off to war, which is most appropriately aligned with the distributive conflict management strategies. Battlers believe that conflict should take on an approach where the battler must win the conflict at all costs without regard to the damage they might cause along the way. Furthermore, battlers tend to be very personalistic in their goals and are often highly antagonistic towards those individuals with whom they are engaging in conflict.⁴³

Alan Sillars, Stephen, Coletti, Doug Parry, and Mark Rogers created a taxonomy of different types of strategies that people can use when using distributive conflict management strategies. Table 9.9 provides a list of these common tactics.⁴⁴

Conflict Management Tactic	Definition	Example
Faulting	Statements that verbally criticize a partner.	“Wow, I can’t believe you are so dense at times.”
Rejection	Statements that express antagonistic disagreement.	“That is such a dumb idea.”
Hostile Questioning	Questions designed to fault a partner.	“Who died and made you king?”
Hostile Joking	Humorous statements designed to attack a partner.	“I do believe a village has lost its idiot.”
Presumptive Attribution	Statements designed to point the meaning or origin of the conflict to another source.	“You just think that because your father keeps telling you that.”
Avoiding Responsibility	Statements that deny fault.	“Not my fault, not my problem.”
Prescription	Statements that describe a specific change to another’s behavior.	“You know, if you’d just stop yelling, maybe people would take you seriously.”
Threat	Statements designed to inform a partner of a future punishment.	“You either tell your mother we’re not coming, or I’m getting a divorce attorney.”
Blame	Statements that lay culpability for a problem on a partner.	“It’s your fault we got ourselves in this mess in the first place.”
Shouting	Statements delivered in a manner with an increased volume.	“DAMMIT! GET YOUR ACT TOGETHER!”
Sarcasm	Statements involving the use of irony to convey contempt, mock, insult, or wound another person.	“The trouble with you is that you lack the power of conversation but not the power of speech.”

Table 9.9 Distributive Conflict Management Strategies

Collaborators

The last type of conflicting partners are collaborators. There are a range of collaborating choices, from being completely collaborative in an attempt to find a mutually agreed upon solution, to being compromising when you realize that both sides will need to win and lose a little to come to a satisfactory solution. In both cases, the goal is to use prosocial communicative behaviors in an attempt to reach a solution everyone is happy with. Admittedly, this is often easier said than done. Furthermore, it’s entirely possible that one side says they want to collaborate, and the other side refuses to collaborate at all. When this happens, collaborative conflict management strategies may not be as effective, because it’s hard to collaborate with someone who truly believes you need to lose the conflict.

Alan Sillars, Stephen Coletti, Doug Parry, and Mark Rogers created a taxonomy of different types of strategies that people can use when collaborating during a conflict. Table 9.10 provides a list of these

Conflict Management Tactic	Definition	Example
Descriptive Acts	Statements that describe obvious events or factors.	“Last time your sister babysat our kids, she yelled at them.”
Qualification	Statements that explicitly explain the conflict.	“I am upset because you didn’t come home last night.”
Disclosure	Statements that disclose one’s thoughts and feelings in a non-judgmental way.	“I get really worried when you don’t call and let me know where you are.”
Soliciting Disclosure	Questions that ask another person to disclose their thoughts and feelings.	“How do you feel about what I just said?”
Negative Inquiry	Statements allowing for the other person to identify your negative behaviors.	“What is it that I do that makes you yell at me?”
Empathy	Statements that indicate you understand and relate to the other person’s emotions and experiences.	“I know this isn’t easy for you.”
Emphasize Commonalities	Statements that highlight shared goals, aims, and values.	“We both want what’s best for our son.”
Accepting Responsibility	Statements acknowledging the part you play within a conflict.	“You’re right. I sometimes let my anger get the best of me.”
Initiating Problem-Solving	Statements designed to help the conflict come to a mutually agreed upon solution.	“So let’s brainstorm some ways that will help us solve this.”
Concession	Statements designed to give in or yield to a partner’s goals, aims, or values.	“I promise, I will make sure my homework is complete before I watch television.”

Table 9.10 Integrative Conflict Management Strategies

Before we conclude this section, we do want to point out that conflict management strategies are often reciprocated by others. If you start a conflict in a highly competitive way, do not be surprised when your conflicting partner mirrors you and starts using distributive conflict management strategies in return. The same is also true for integrative conflict management strategies. When you start using integrative conflict management strategies, you can often deescalate a problematic conflict by using integrative conflict management strategies.⁴⁶

STLC Conflict Model

Ruth Anna Abigail and Dudley Cahn created a very simple model when thinking about how we communicate during conflict.⁴⁷ They called the model the STLC Conflict Model because it stands for stop,



Figure 9.3 STLC Conflict Model

think, listen, and then communicate.

Stop

The first thing an individual needs to do when interacting with another person during conflict is to take the time to be present within the conflict itself. Too often, people engaged in a conflict say whatever enters their mind before they've really had a chance to process the message and think of the best strategies to use to send that message.

Others end up talking past one

another during a conflict because they simply are not paying attention to each other and the competing needs within the conflict. Communication problems often occur during conflict because people tend to react to conflict situations when they arise instead of being mindful and present during the conflict itself. For this reason, it's always important to take a breath during a conflict and first stop.

Sometimes these "time outs" need to be physical. Maybe you need to leave the room and go for a brief walk to calm down, or maybe you just need to get a glass of water. Whatever you need to do, it's important to take this break. This break takes you out of a "reactive stance into a proactive one."⁴⁸

Think

Once you've stopped, you now have the ability to really think about what you are communicating. You want to think through the conflict itself. What is the conflict really about? Often people engage in conflicts about superficial items when there are truly much deeper issues that are being avoided. You also want to consider what possible causes led to the conflict and what possible courses of action you think are possible to conclude the conflict. Cahn and Abigail argue that there are four possible outcomes that can occur: do nothing, change yourself, change the other person, or change the situation.

First, you can simply sit back and avoid the conflict. Maybe you're engaging in a conflict about politics with a family member, and this conflict is actually just going to make everyone mad. For this reason, you opt just to stop the conflict and change topics to avoid making people upset. One of our coauthors was at a funeral when an uncle asked our coauthor about our coauthor's impression of the current President. Our coauthor's immediate response was, "Do you really want me to answer that question?" Our coauthor knew that everyone else in the room would completely disagree, so our coauthor knew this was probably a can of worms that just didn't need to be opened.

Second, we can change ourselves. Often, we are at fault and start conflicts. We may not even realize how our behavior caused the conflict until we take a step back and really analyze what is happening. When it comes to being at fault, it's very important to admit that you've done wrong. Nothing is worse (and can stoke a conflict more) than when someone refuses to see their part in the conflict.

Third, we can attempt to change the other person. Let's face it, changing someone else is easier said than done. Just ask your parents/guardians! All of our parents/guardians have attempted to change

our behaviors at one point or another, and changing people is very hard. Even with the powers of punishment and reward, a lot of time change only lasts as long as the punishment or the reward. One of our coauthors was in a constant battle with our coauthors' parents about thumb sucking as a child. Our coauthor's parents tried everything to get the thumb sucking to stop. They finally came up with an ingenious plan. They agreed to buy a toy electric saw if their child didn't engage in thumb sucking for the entire month. Well, for a whole month, no thumb sucking occurred at all. The child got the toy saw, and immediately inserted the thumb back into our coauthor's mouth. This short story is a great illustration of the problems that can be posed by rewards. Punishment works the same way. As long as people are being punished, they will behave in a specific way. If that punishment is ever taken away, so will the behavior.

Lastly, we can just change the situation. Having a conflict with your roommates? Move out. Having a conflict with your boss? Find a new job. Having a conflict with a professor? Drop the course. Admittedly, changing the situation is not necessarily the first choice people should take when thinking about possibilities, but often it's the best decision for long-term happiness. In essence, some conflicts will not be settled between people. When these conflicts arise, you can try and change yourself, hope the other person will change (they probably won't, though), or just get out of it altogether.

Listen

The third step in the STLC model is listen. Humans are not always the best listeners. As we discussed in Chapter 7, listening is a skill. Unfortunately, during a conflict situation, this is a skill that is desperately needed and often forgotten. When we feel defensive during a conflict, our listening becomes spotty at best because we start to focus on ourselves and protecting ourselves instead of trying to be empathic and seeing the conflict through the other person's eyes.

One mistake some people make is to think they're listening, but in reality, they're listening for flaws in the other person's argument. We often use this type of selective listening as a way to devalue the other person's stance. In essence, we will hear one small flaw with what the other person is saying and then use that flaw to demonstrate that obviously everything else must be wrong as well.

The goal of listening must be to suspend your judgment and really attempt to be present enough to accurately interpret the message being sent by the other person. When we listen in this highly empathic way, we are often able to see things from the other person's point-of-view, which could help us come to a better-negotiated outcome in the long run.

Communicate

Lastly, but certainly not least, we communicate with the other person. Notice that Cahn and Abigail put communication as the last part of the STLC model because it's the hardest one to do effectively during a conflict if the first three are not done correctly. When we communicate during a conflict, we must be hyper-aware of our nonverbal behavior (eye movement, gestures, posture, etc.). Nothing will kill a message faster than when it's accompanied by bad nonverbal behavior. For example, rolling one's eyes while another person is speaking is not an effective way to engage in conflict. One of our coauthors used to work with two women who clearly despised one another. They would never openly say something negative about the other person publicly, but in meetings, one would roll her eyes and make these non-word sounds of disagreement. The other one would just smile, slow her speech, and look in the other woman's direction. Everyone around the conference table knew exactly what was transpiring, yet no words needed to be uttered at all.

During a conflict, it's important to be assertive and stand up for your ideas without becoming verbally

aggressive. Conversely, you have to be open to someone else's use of assertiveness as well without having to tolerate verbal aggression. We often end up using mediators to help call people on the carpet when they communicate in a fashion that is verbally aggressive or does not further the conflict itself. As Cahn and Abigail note, "People who are assertive with one another have the greatest chance of achieving mutual satisfaction and growth in their relationship."⁴⁹

MINDFULNESS ACTIVITY



The STLC Model for Conflict is definitely one that is highly aligned with our discussion of mindful interpersonal relationships within this book. Taylor Rush, a clinical psychologist working for the Cleveland Clinic's Center for Neuro-Restoration, recommends seven considerations for ensuring mindfulness while engaged in conflict:

- 1. Set intentions.** What do you want to be discussed during this interaction? What do you want to learn from the other person? What do you want to happen as a result of this conversation? Set your intentions early and check-in along the way to keep the conversation on point.
- 2. Stay present to the situation.** Try to keep assumptions at bay and ask open-ended questions to better understand the other person's perspective and experiences.
- 3. Stay aware of your inner reactions.** Disrupt the automatic feedback loop between your body and your thoughts. Acknowledge distressing or judgmental thoughts and feelings without reacting to them. Then check them against the facts of the situation.
- 4. Take one good breath before responding.** A brief pause can mean all the difference between opting for a thoughtful response or knee-jerk reaction.
- 5. Use reflective statements.** This is a tried and true strategy for staying present. It allows you to fully concentrate on what the other person is saying (rather than form your rebuttal) and shows the other person you have an interest in what they are actually saying. This will make them more likely to reciprocate!
- 6. Remember, it's not all about you.** The ultimate objective is that both parties are heard and find the conversation beneficial. Try to actively take the other person's perspective and cultivate compassion (even if you fundamentally do not agree with their position). This makes conflict escalation much less likely.
- 7. Investigate afterward.** What do you feel now that the conversation is over? What was the overall tone of the conversation? Do you feel like you understand the other person's perspective? Do they understand yours? Will this require further conversation or has the issue been resolved? Asking these questions will help you to hone your practice for the future.⁵⁰

For this activity, we want you to think back to a recent conflict that you had with another person (e.g., coworker, friend, family member, romantic partner). Answer the following questions:

1. If you used the STLC Model for Conflict, how effective was it for you? Why?
2. If you did not use the STLC Model for Conflict, do you think you could have benefited from this approach? Why?
3. Looking at Rush's seven strategies for engaging in mindful conflict, did you engage in all of them? If you didn't engage in them all, which ones did you engage in, and which ones didn't you engage in? How could engaging in all seven of them help your conflict management with this person?

4. If you haven't already, take a moment to think about the questions posed in #7 of Rush's list. What can you learn from this conflict that will help prepare you for future conflicts with this person or future conflicts more broadly?

Key Takeaways

- A conflict occurs when two people perceive differing goals or values, and if the two parties do not reach a solution, the interpersonal relationship could be seriously fractured. An argument, on the other hand, is a difference of opinion that occurs between two people during an argument. The primary difference between a conflict and an argument involves the emotional volatility of the situation. However, individuals with a low tolerance for disagreement may perceive any form of argument as interpersonal conflict.
- In this section, we discussed three basic forms of conflict management: integrative (collaborators), distributive (battlers), and avoidance (avoiders). Integrative conflict occurs when two people attempt a win-win situation where the conflict parties strive to find a mutually beneficial solution to a problem. Distributive conflict occurs when one or both conflict parties desire a win-lose orientation where they will win and the other person will lose. Lastly, we have avoidance, which occurs when an individual either tries to avoid a conflict altogether or leaves the conflict field.
- Dudley Cahn and Ruth Anna Abigail's STLC method for communication is very helpful when working through conflict with others. STLC stands for stop, think, listening, and communicate. Stop and time to be present within the conflict itself and prepare. Think through the real reasons for the conflict and what you want as an outcome for the conflict. Listen to what the other person says and try to understand the conflict from their point-of-view. Communicate in a manner that is assertive, constructive, and aware of your overall message.

Exercises

- Think of a time when a simple disagreement escalated to a conflict. What happened? Why did this escalation occur?
- During conflict, do you think it's appropriate to use all three forms of conflict management? Why?
- Think of a recent interpersonal conflict that you had that went badly. How could you have implemented the STLC Model of Conflict to improve what happened during that conflict?

Chapter Wrap-Up

As we discussed at the beginning of this chapter, conflict in interpersonal relationships is inevitable. The only way relationships can truly grow is through conflict, so learning how to manage conflict effectively is essential for successful interpersonal relationships.

KEY TERMS

- Accidental Communication
- Alexithymia
- Argument
- Avoidance
- Coercive Power
- Compliance
- Conflict
- Disagreement
- Distributive Conflict
- Dunning–Kruger Effect
- emotional awareness
- Emotional Intelligence
- Emotions
- Expert Power
- Expressive Communication
- Feelings
- Identification
- Influence
- Informational Power
- Integrative Conflict
- Interdependence
- Internalization
- Legitimate Power
- Power
- Procedural Disagreements
- Referent Power
- Reward Power
- Rhetorical Communication
- Substantive Disagreement
- Tolerance for Disagreement
- “You” Statements

REAL WORLD CASE STUDY

Paul has been in a yearlong relationship with his boyfriend Bill. Paul really loves the idea of being in love, but he’s just not in love with Bill at all. Unfortunately, on Valentine’s Day, he made the mistake of telling Bill that he loved him even though he just doesn’t. As far as Paul is concerned, he could end the relationship today.

Bill, on the other hand, fell madly in love with Paul almost immediately after they started hanging out and going to the gym together. One day when Bill and Paul were hanging out watching TV, he looked at Paul and told him that he loved him. Bill immediately noticed that Paul looked like a deer in headlights and let him off easy saying, “There’s no need to say it back if you’re not ready to do so.”

Ultimately, the relationship became more like a really good friendship than a romantic relationship. The two hung out and went to dinner and saw movies, but were never really intimate with one another at all. Paul kept up the charade because he kind of liked some of the perks of being in a relationship. He liked having someone to hang out with all the time. He liked having someone who cleaned his house and cooked for him. He liked having someone who would look after his cats when he went on vacation.

Over time, Bill started to realize that something was wrong with the relationship. One day when he and Paul were talking about the future, he told Paul, “I want to be everything for you.” He immediately saw that once again Paul looked like a deer trapped in headlights. Over time, Bill

started noticing that Paul was getting more and more distant. He really loved Paul, but he started to realize that it really wasn't being reciprocated the same way. Instead of saying something, he just shook the thoughts out of his mind and kept going.

1. Would you classify this as a healthy relationship?
1. Why do you think Paul has such a hard time being honest with Bill?
2. Why do you think Bill was so determined to make the relationship work when it was clearly not being reciprocated?
3. How would you describe the emotional quality of this relationship?
4. How do you think this couple would engage in conflict?

END OF CHAPTER QUIZ

1. Jonathan loves to debate a wide range of ideas. In fact, he has no problems arguing for or against something just to engage in a healthy debate with another person. Which personality trait does Jonathan exhibit?
 - a. need for cognition
 - b. argumentativeness proneness
 - c. conflict avoidance
 - d. high tolerance for disagreement
2. Which of the following represents a nonviolent communicative message?
 - a. silence
 - b. placating
 - c. playing games
 - d. aggressive behavior
 - e. violence
3. Which of the following is not an effective statement when communicating about one's feelings?
 - a. "If you flirt with one more person, I'm going to hurt myself, and it will be your fault."
 - b. "I hate it when you flirt with other people."
 - c. "I feel lonely when you flirt with other people because I need emotional safety."
 - d. "You make me feel like a piece of trash when you flirt with other people."
4. Viivi is a Norwegian language instructor. As she teaches about Norwegian, she also peppers in a variety of culture factors into her teachings. One of her students, Jim, really wants to spend a summer abroad in Norway, so Jim listens attentively to everything Viivi has to offer. Because of Viivi's knowledge of Norway, Jim hangs on every word. What type of power best represents Viivi's?
 - a. coercive
 - b. reward
 - c. legitimate
 - d. expert
 - e. referent

5. Hodoya is a Canadian union leader. She's currently involved in negotiations with a large uranium production company. Hodoya sees her job as the lead negotiator to get the best possible deal for her union members. As such, she goes into negotiations with a win-lose orientation. What type of conflict management strategies will Hodoya employ?
- a. avoidance
 - b. distributive
 - c. competitive
 - d. collaborative
 - e. integrative

References

- 1 McCroskey, J. C., & Wheelless, L. (1976). *An introduction to human communication*. Allyn & Bacon.
- 2 Knutson, P. K., McCroskey, J. C., Knutson, T., & Hurt, H. (1979, February). *Tolerance for disagreement: Interpersonal conflict reconceptualized*. Paper presented at the Annual Convention of the Western Speech Communication, Los Angeles, CA.
- 3 Richmond, V. P., & McCroskey, J. C. (1979). Management communication style, tolerance for disagreement, and innovativeness as predictors of employee satisfaction: A comparison of single-factor, two-factor, and multiple-factor approaches. *Communication Yearbook*, 3, 359-373.
- 4 Simons, H. W. (1972). Persuasion in social conflicts: A critique of prevailing conceptions and a framework for future research. *Speech Monographs*, 39(4), 227-247. <https://doi.org/10.1080/03637757209375763>
- 5 McCroskey, J. C., & Wheelless, L. R. (1976). *An introduction to human communication*. Allyn & Bacon.
- 6 Ibid.; pg. 247.
- 7 McCroskey, J. C., & Richmond, V. P. (1996). *Fundamentals of human communication: An interpersonal perspective*. Waveland Press.
- 8 Richmond, V. P., McCroskey, J. C., & McCroskey, L. L. (2005). *Organizational communication for survival: Making work, work* (3rd ed.). Allyn & Bacon.
- 9 Ibid.; pg. 176.
- 10 Ibid.; pg. 177.
- 11 Cahn, D. D., Abigail, R. A. (2014). *Managing conflict through communication* (5th ed.). Allyn & Bacon.
- 12 Cahn, D. D., Abigail, R. A. (2011). *Managing conflict through communication* (4th ed.). Allyn & Bacon; pg. 4.
- 13 Cahn, D. D., Abigail, R. A. (2014). *Managing conflict through communication* (5th ed.). Allyn & Bacon; pg. 4.
- 14 Ibid.; pg. 4.
- 15 Yellowstone National Park Staff. (2015, February 15). Why do geysers erupt? Retrieved from: <https://www.yellowstonepark.com/things-to-do/geysers-erupt>
- 16 Bloch, L., Haase, C. M., & Levenson, R. W. (2014). Emotion regulation predicts marital satisfaction: More than a wives' tale. *Emotion*, 14(1), 130-144. <https://doi.org/10.1037/a0034272>
- 17 Friedman, S. R., Rapport, L. J., Lumley, M., Tzelepis, A., VanVoorhis, A., Stettner, L., & Kakaati, L. (2003). Aspects of social and emotional competence in adult attention-deficit/hyperactivity disorder. *Neuropsychology*, 17(1), 50-58. <https://doi.org/10.1037/0894-4105.17.1.50>
- 18 Rosenberg, M. B. (2003). *Nonviolent communication: A language of life* (2nd ed.). Puddle Dancer Press.
- 19 Ibid.
- 20 Salovey, P., & Mayer, J. D. (1990). Emotional intelligence. *Imagination, Cognition, and Personality*, 9, 185-211.
- 21 Bodenmann, G. (2008). *DCI - Dyadisches coping inventar*. Huber.
- 22 Bodenmann, G., Falconier, M. K., & Randall, A. K. (2019). Editorial: Dyadic coping. *Frontiers in psychology*, 10, 1498. <https://doi.org/10.3389/fpsyg.2019.01498>
- 23 Wollny, A., Jacobs, I., & Pabel, L. (2020, 2020/01/02). Trait emotional intelligence and relationship satisfaction: The mediating role of dyadic coping. *The Journal of Psychology*, 154(1), 75-93. <https://doi.org/10.1080/00223980.2019.1661343>; pg. 78.
- 24 Simon, S. B. (1977). *Vulture: A modern allegory on the art of putting oneself down*. Niles, IL: Argus Communications.
- 25 Aron, E. N., & Aron, A. (1996). Love and the expansion of the self: The state of the model. *Personal Relationships*, 3(1), 45-58. <https://doi.org/10.1111/j.1475-6811.1996.tb00103.x>
- 26 Gottman, J. M., Coan, J., Carrere, S. & Swanson, C. (1998). Predicting marital happiness and stability from newlywed interactions. *Journal of Marriage and Family*, 60, (1), 5-22. <https://doi.org/10.2307/353438>
- 27 Wrench, J. S., McCroskey, J. C., & Richmond, V. P. (2008). *Human communication in everyday life: Expla-*

nations and applications. Allyn & Bacon; pg. 423.

- 28 Kelman, H. (1958). Compliance, identification, and internalization: Three processes of attitude change. *Journal of Conflict Resolution*, 2(1), 51-60. <https://doi.org/10.1177/002200275800200106>
- 29 Wheelless, L. R., Barraclough, R., & Stewart, R. (1983). Compliance-gaining and power in persuasion. In R. N. Bostrom (Ed.), *Communication Yearbook 7* (pp. 105-145). Sage.
- 30 McCroskey, J. C. (1992). *An introduction to communication in the classroom*. Burgess.
- 31 Kelman, H. (1958). Compliance, identification, and internalization: Three processes of attitude change. *Journal of Conflict Resolution*, 2(1), 51-60. <https://doi.org/10.1177/002200275800200106>
- 32 French, J. R. P., Jr., & Raven, B. H. (1959). The bases of social power. In D. Cartwright (Ed.), *Studies in social power* (pp. 150–167). Institute for Social Research.
- 33 Ibid.
- 34 Raven, B. H. (1965). Social influence and power. In I.D. Steiner & M. Fishbein (Eds.), *Current studies in social psychology* (pp. 371–382). Holt, Rinehart, Winston.
- 35 Ibid.
- 36 Raven, B. H. (2008). The bases of power and the power/interaction model of interpersonal influence. *Analyses of Social Issues and Public Policy*, 8, 1-22.
- 37 French, J. R. P., Jr., & Raven, B. H. (1959). The bases of social power. In D. Cartwright (Ed.), *Studies in social power* (pp. 150–167). Institute for Social Research.
- 38 Bauerlein, M. (2008). *The dumbest generation: how the digital age stupefies young Americans and jeopardizes our future (or, don't trust anyone under 30)*. Penguin.
- 39 Kruger, J., & Dunning, D. (1999). Unskilled and unaware of it: How difficulties in recognizing one's own incompetence lead to inflated self-assessments. *Journal of Personality And Social Psychology*, 77(6), 1121–1134. <https://doi.org/10.1037/0022-3514.77.6.1121>
- 40 Wrench, J. S., McCroskey, J. C., & Richmond, V. P. (2008). *Human communication in everyday life: Explanations and applications*. Allyn & Bacon.
- 41 Walton, R. E., & McKersie, R. B. (1965). *A behavioral theory of labor negotiations: An analysis of a social interaction system*. McGraw-Hill.
- 42 Sillars, A. L., Coletti, S., Parry, D., & Rogers, M. (1982). Coding verbal conflict tactics: Nonverbal and perceptual correlates of the 'avoidance-competitive-cooperative' distinction. *Human Communication Research*, 9(1), 83-95. <https://doi.org/10.1111/j.1468-2958.1982.tb00685.x>
- 43 Ibid.
- 44 Ibid.
- 45 Ibid.
- 46 Wrench, J. S., & McGee, D. S. (2000, November). *The influence of saliency and family communication patterns on adolescent perceptions of adolescent and parent conflict management strategies*. Paper presented at the National Communication Association's Convention, Seattle, WA.
- 47 Cahn D. D., & Abigail, R. A. (2014). *Managing conflict through communication* (5th ed.). Pearson Education.
- 48 Ibid.; pg. 79.
- 49 Ibid.; pg. 83.
- 50 Rush, T. (2018, March 15). Applying mindfulness for better conflict management: Tips to try the next time you're facing a dispute with a colleague. *ConsultQD*. <https://tinyurl.com/ulq3vn8>; paras. 7-13.

END OF CHAPTER QUIZ

ANSWER KEY

- 1) E 2) C 3) A 4) D 5) D



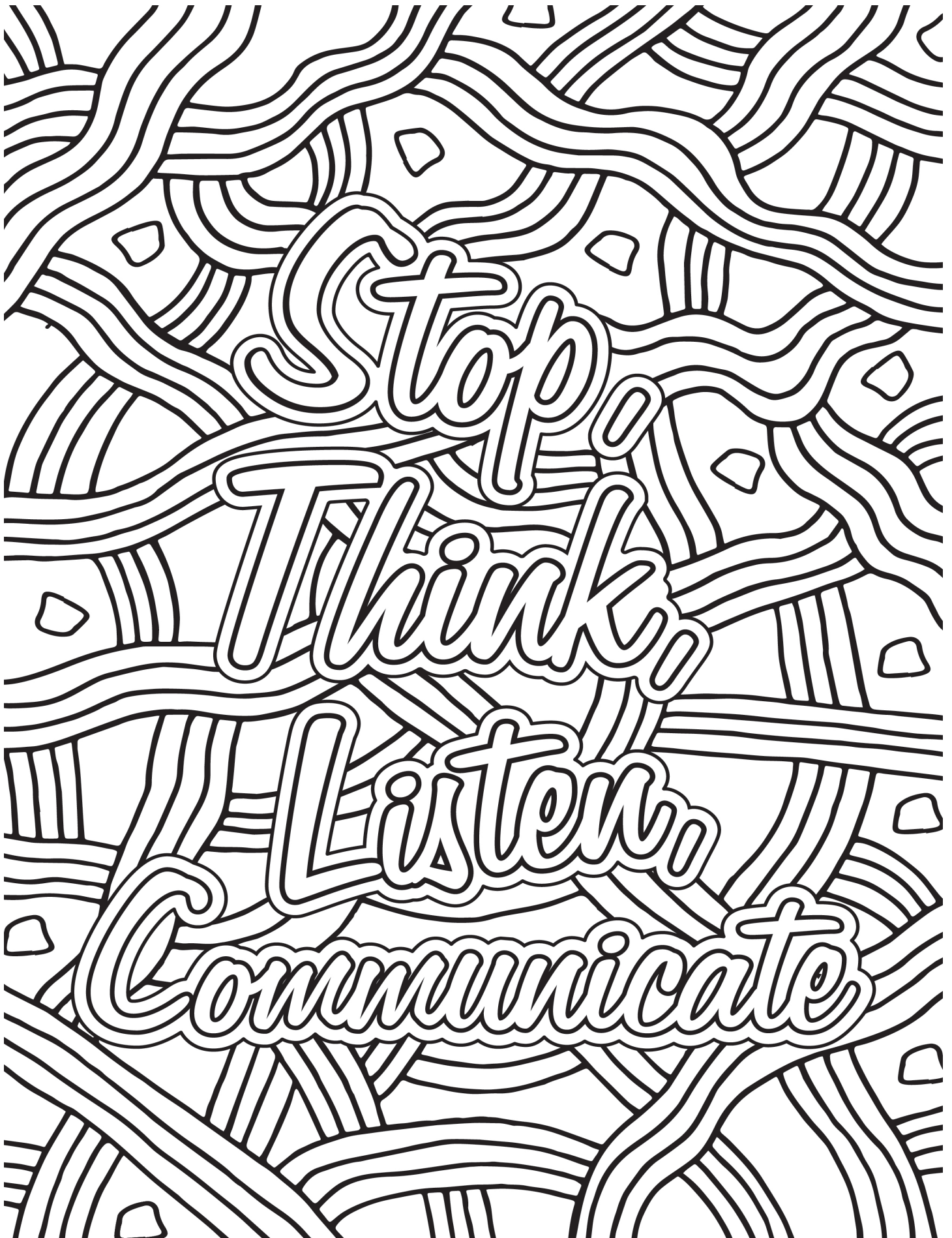



Image by [Alexas](#) Fotos from [Pixabay](#)

Chapter 10

Friendship Relationships

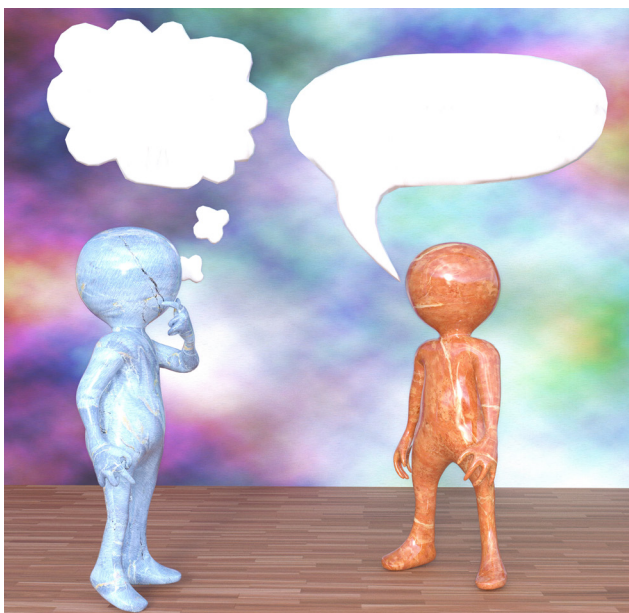

Figure 10.1. Interpersonal Communication

When you hear the words “friend” or “friendship,” what comes to mind? In today’s society, the words “friend” and “friendship” can refer to a wide range of different relationships or attachments. We can be a friend of a library, museum, opera, theatre, etc. We can be a friend to someone in need. We can friend thousands of people on social media platforms like Facebook. We can develop friendships with people in our day-to-day lives at work, in social groups, at school, at church, etc. Some people see their parents/guardians, spouses, and siblings as “friends.” Many of us even have one or more best friends. So, when we look at all of these different areas where we use the word “friend,” do we mean the same thing? In this chapter, we’re going to delve into the world of interpersonal friendships, which at least takes a few items off of our list of friendships (e.g., libraries, museums, operas), but we’re still left with a term that is very difficult to define.

Beverly Fehr was one of the first scholars to note the problem related to defining the term “friendship”: “Everyone knows what friendship is – until asked to define it. There are virtually as many definitions of friendship as there are social scientists studying the topic.”¹ Table 10.1 presents some sample definitions that exist in the literature for the terms “friend” or “friendship.”

Anthropological	“A friendship-like relationship is a social relationship in which partners provide support according to their abilities in times of need, and in which this behavior is motivated in part by positive affect between partners.” ²
Clinical Psychology	“[S]omeone who likes and wishes to do well for someone else and who believes that these feelings and good intentions are reciprocated by the other party.” ³
Dictionary	“The emotions or conduct of friends; the state of being friends.” ⁴
Evolutionary	“Friendship is a long-term, positive relationship that involves cooperation.” ^{5,6}
Friendship as Love	“The etymology of word <i>friend</i> connects its meaning with love, freedom and choice, suggesting an ideal definition of friendship as a voluntary relationship that includes a mutual and equal emotional bond, mutual and equal care and goodwill, as well as pleasure.” ⁷
Legal	“Friendship is a word of broad and varied application. It is commonly used to describe the undefinable relationships which exist not only between those connected by ties of kinship or marriage, but as well between strangers in blood, and which vary in degree from the greatest intimacy to an acquaintance more or less casual.” ⁸
Personality	“[V]oluntary, mutual, flexible, and terminable; relationships that emphasize equality and reciprocity, and require from each partner an affective involvement in the total personality of the other.” ⁹
Philosophy	“[A] distinctively personal relationship that is grounded in a concern on the part of each friend for the welfare of the other, for the other’s sake, and that involves some degree of intimacy.” ¹⁰
Social Psychology	“[V]oluntary or unrestrained interaction in which the participants respond to one another personally, that is, as unique individuals rather than as packages of discrete attributes or mere role occupants.” ¹¹

Table 10.1 Defining Friendship

As you can see, there are several different ways that scholars can define the term “friendship.” So, we must question whether defining the term “friendship” is the best way to start a discussion of this topic.

10.1 Friendship Relationships

LEARNING
OUTCOMES

1. Evaluate Rawlins' friendship characteristics.
2. Analyze the importance of communication in the formation of friendships.
3. Appraise Rawlins' dialectical approach to friendships.

In a 2017 book on the psychology of friendship, Michael Monsour asked the different chapter authors if they planned on defining the term “friendship” within their various chapters.¹² Monsour found that the majority of the authors planned on not defining the term “friendship,” but instead planned on identifying characteristics of the term “friendship.” We point this out because defining “friend” and “friendship” isn’t an easy thing to do. We all probably see our friendships as different or unique, which is one of the reasons why defining the terms is so hard. For our purposes in this chapter, we’re going to go along with the majority of friendship scholars and not provide a strict definition for the term.

Friendship Characteristics

William K. Rawlins, a communication scholar and one of the most influential figures in the study of friendship, argues that friendships have five essential characteristics that make them unique from other forms of interpersonal relationships: voluntary, personal, equality, involvement, and affect (Figure 10.2).¹³



Figure 10.2. Friendship

All Friendships are Essentially Voluntary

There’s an old saying that goes, “You can’t choose your family, but you can choose your friends.” This saying affirms the basic idea that friendship relationships are voluntary. Friendships are based out of an individual’s free will to choose whom they want to initiate a friendship relationship with. We go through our lives constantly making decisions to engage in a friendship with one person and not engage in a friendship with another person. Each and every one of us has our reasons for friendships. For example, one of our coauthors originally established a friendship with a peer during graduate school because they were the two youngest people in the program. In this case, the friendship was initiated because of demographic homophily but continues almost 20 years later because they went on to establish a deeper, more meaningful relationship over time. Take a second and think about

your friendships. Why did you decide to engage in those friendships? Of course, the opposite is also true. We meet some people and never end up in friendship with them. Sometimes it's because you're not interested or the other person isn't interested (voluntariness works both ways). We also choose to end some friendships when they are unhealthy or no longer serve a specific purpose within our lives.

Friendships are Personal Relationships that are Negotiated Between Two Individuals

The second quality of friendships is that they are personal relationships negotiated between two individuals. In other words, we create our friendships with individuals and we negotiate what those relationships look like with that other individual. For example, let's imagine you meet a new person named Kris. When you enter into a relationship with Kris, you negotiate what that relationship will look like with Kris. If Kris happens to be someone who is transgendered, you are still entering into a relationship with Kris and not everyone who is transgendered. Kris is not the ambassador for all things transgendered for us, but rather a unique individual we decide we want to be friends with. Hence, these are not group relationships; these are individualized, personal relationships that we establish with another person.

Friendships Have a Spirit of Equality

The next characteristic of friendships is a spirit of equality. Rawlins notes, "Although friendship may develop between individuals of different status, ability, attractiveness, or age, some facet of the relationship functions as a leveler. Friends tend to emphasize the personal attributes and styles of interaction that make them appear more or less equal to each other."¹⁴ It's important to note that we're not saying a 50/50 split in everything is what makes a friendship equal. Friendships ebb and flow over time as friends' desires, needs, and interests change. For example, it's perfectly possible for two people from very different social classes to be friends. In this case, the different social classes may put people at an imbalance when it comes to financial means, but this doesn't mean that the two cannot still have a sense of equality within the relationship. Here are some ways to ensure that friendships maintain a spirit of equality:

1. Both friend's needs and desires are important, not just one person's.
2. Both friends are curious about their friend's personal life away from the friendship.
3. Both friends show affection in their own ways.
4. Both friends demonstrate effort and work in the relationship.
5. Both friends encourage the other's goals and dreams.
6. Both friends are responsible for mutual happiness.
7. Both friends decide what activities to pursue and how to have fun.
8. Both friends are mutually engaged in conversations.
9. Both friends carry the other's burdens.
10. Both friends desire for the relationship to continue and grow.

Friendships Have Mutual Involvement

The fourth characteristic of friendships is that they require mutual involvement. For friendships to work, both parties have to be mutually engaged in the relationship. This does not mean that friends have to

talk on a daily, weekly, or even monthly basis for them to be effective. Many people establish long-term friendships with individuals they don't get to see more than once a year or even once a decade. For example, my father has a group of friends from high school whom he meets up with once a year. His friends and their spouses pick a location, and they all meet up once a year for a week together. For the rest of the year, there are occasional emails and Facebook posts, but they don't interact much outside of that. However, that once a year get together is enough to keep these long-term (70+ years at this point) friendships healthy and thriving.

The concept of "mutual involvement" can differ from one friendship pair to another. Different friendship pairs collaborate to create their sense of what it means to be a friend, their shared social reality of friendship. Rawlins states, "This interpersonal reality evolves out of and furthers mutual acceptance and support, trust and confidence, dependability and assistance, and discussion of thoughts and feelings."¹⁵ One of the reasons why defining the term "friendship" is so difficult is because there are as many friendship realities as there are pairs of friends. Although we see common characteristics among them, it's important to understand that these characteristics have many ways of being exhibited.

Friendships Have Affective Aspects

The final characteristic of friendships is the notion of affect. **Affect** refers to "any experience of feeling or emotion, ranging from suffering to elation, from the simplest to the most complex sensations of feeling, and from the most normal to the most pathological emotional reactions. Often described in terms of positive affect or negative affect, both mood and emotion are considered affective states."¹⁶ Built into the voluntariness, personal, equal, and mutually involved nature of friendships is the inherent caring and concern that we establish within those friendships, the affective aspects. Some friends will go so far as to say that they love each other. Not in the *eros* or romantic sense of the term, but instead in the *philia* or affectionate sense of the term. People often use the term "platonic" love to describe the love that exists without physical attraction based on the writings of Plato. However, Aristotle, Plato's student, believed that *philia* was an even more profound form of dispassionate, virtuous love that existed in the loyalty of friends void of any sexual connotations.

All friendships are going to have affective components, but not all friendships will exhibit or express affect in the same ways. Some friendships may exhibit no physical interaction at all, but this doesn't mean they are not intimate emotionally, intellectually, or spiritually. Other friendships could be very physically affective, but have little depth to them in other ways. Every pair of friends determines what the affect will be like within that friendship pairing. However, both parties within the relationship must have their affect needs met. Hence, people often need to have conversations with friends about their needs for affection.

Communication and Friendship Formation

Now that we've explored the five basic characteristics of friendships, let's switch gears and focus on communication and friendships. This entire chapter is about communication and friendships, but we're going to explore two communication variables that impact the formation of friendships.

Communication Competence

Previously in this book, we talked about the notion of **communication competence**. For our purposes, we used the definition from John Wiemann, "the ability of an interactant to choose among available communicative behaviors in order that he [she/they] may successfully accomplish his [her/their] own

interpersonal goals, while maintaining the face and line of his [her/their] fellow interactants within the constraints of the situation.”¹⁷ Not surprisingly, an individual’s communication competence impacts their friendships. Kenneth Rubin and Linda Rose-Krasnor took communication competence a step further and referred to social communicative competencies, “ability to achieve personal goals in social interaction while simultaneously maintaining positive relationships.”¹⁸ The most common place where we exhibit social competencies is within our friendships. Throughout our lifespans, we continue to develop our social communicative competencies through our continued interactions with others. However, individuals with lower levels of competency will have problems in their day-to-day communicative interactions. Analisa Arroyo and Chris Segrin tested this idea and found that individuals who reported having lower levels of communication competence were less satisfied in their friendships.¹⁹ Furthermore, individuals who rated a specific friend as having lower levels of communication competency reported lower levels of both friendship satisfaction and commitment. So right off the bat people with lower levels of communication competence are going to have problems in their communicative interactions with friends.

Communication Apprehension

Another variable of interest to communication scholars has been communication apprehension (CA). We know that peers tend to undervalue their quieter peers, generally seeing them as less credible and socially attractive.²⁰ In a study examining friendships among college students, participants indicated how many people they would classify as “good friends.”²¹ Over one-third of the people with high levels of CA reported having no good friends at all. No students with low or average levels of CA reported having no good friends. Over half of high CA individuals also reported family members as being their good friends (e.g., siblings, parents/guardians, cousins). Less than 5% of individuals with low or average levels of CA mentioned relatives. Ultimately, we know it’s harder for people with higher levels of CA to establish relationships and keep those relationships growing. Furthermore, individuals with higher levels of CA are less satisfied with their communicative interactions with friends.²²

As you can see, both communication competence and CA are important aspects of communication that impact the establishment of effective friendship relationships.

Dialectical Approaches to Friendships

Earlier in this book, we introduced you to the dialectical perspective for understanding interpersonal relationships. William K. Rawlins proposed a dialectical approach to friendships.²³ The dialectics can be broken down into two distinct categories: contextual and interactional.

Contextual Dialectics

The first category of dialectics is **contextual dialectics**, which are dialectics that stem out of the cultural order where the friendship exists. If the friends in question live in the United States, then the prevailing social order in the United States will impact the friendship. However, if the friends are in Malaysia, then the Malaysian culture will be the prevailing social order that impacts the friendship. There are two different dialectics that Rawlins labeled as contextual: private/public and ideal/real.

Private/Public

The first friendship dialectic is the private/public dialectic. Let’s start by examining the public side of

friendships in the United States. Sadly, these relationships aren't given much credence in the public space. For example, there are no laws protecting friendships. Your friends can't get health benefits from your job. Religious bodies don't recognize your friendships. As you can see, we're comparing friendships here to marriages, which do have religious and legal protections. In fact, in the legal system, the family often trumps friends unless there is a power of attorney or will.

As a significant historical side note, one of the biggest problems many gay and lesbian couples faced before marriage legalization was that their intimate partners were perceived as "friends" in the legal system. Family members could swoop in when Partner A died and evict and confiscate all of Partner A's money and property unless there was an iron-clad will leaving the money and property to Partner B. From a legal perspective, marriage equality was very important in ensuring the rights of LGBTQIA individuals and their spouses.

On the opposite end of this dialectic, many friendship bonds are as strong if not stronger than familial or marital bonds. We voluntarily enter into friendships and create our sense of purpose and behaviors outside of any religious or legal context. In essence, these friendships are autonomous and outside of social strictures that define the lines of marital bonds. Instead of having a religious organization dictate the morality of a relationship, friendships ultimately develop a sense of morality that is based within the relationship itself.

Ideal/Real

From the moment we are born, we start being socialized into a wide range of relationships. Friendship is one of those relationships. We learn about friendships from our family, schools, media, peers, etc.... With each of these different sources of information, we develop an ideal of what friendship should be. However, friendships are not ideals; they are real, functioning relationships with pluses and minuses. This dialectic also impacts how we communicate and interact within the friendship itself. If our culture tells us that people must be reserved and respectful in private, then a simple act of laughing with another person could be an outward sign of friendship.

Interactional Dialectics

It's important to understand that friendships change over time; along with how we interact within those friendships. For communication scholars, Rawlins **interactional dialectics** help us understand how communicative behavior happens within friendships.²⁴ Rawlins noted four primary communicative dialectics for friendships: independence/dependence, affection/instrumentality, judgment/acceptance, and expressiveness/protectiveness.

Independence/Dependence

First and foremost, friendships are voluntary relationships that we choose. However, there is a constant pull between the desire to be an independent person and the willingness to depend on one's friend. Let's look at a quick example. A few weeks ago, you and one of your friends both mentioned that you wanted to see a new film getting released. A few weeks later, it's a Friday afternoon and you're done with class or work. The movie was released that day, so you go and watch a matinee. You decided to engage in behavior without thought of your friend. You acted independently. It's also possible that you know your friend hates going to the movies, so engaging independent movie watching behavior is very much in line with the norms you've established within your friendship.

On the other side, we do depend on our friendships. You could have a friend that you do almost everything with, and it gets to the point that people see you as a duo and are shocked when both of you aren't together. In these highly dependent friendships, individual behavior is probably very infrequent and more likely to be resented. Now, if you went to the movie alone in a highly dependent friendship, your friend may be upset or jealous because you didn't wait to see it with her/him/them. You may have had the right to engage as an independent person, but a friend in a highly dependent friendship would see this as a violation. This story would cause even more friction within the friendship if you had promised your friend to see the movie with her/him/them. You would still be acting independently, but your friend would have a stronger foundation for being upset.

Ultimately, all friendships have to negotiate independence and dependence. As with the establishment of any friendship norm, the pair involved in the relationship needs to decide when it's appropriate to be independent and when it is appropriate to be dependent. Maybe you need to check-in via text 20 times a day (pretty dependent) or talk on the phone once a year; in both cases, friendships are different and are in constant negotiation. It's also important to note that a friendship that was once highly dependent can become highly independent and vice versa.

Affection/Instrumentality

The second interactional dialectic examines the intersection of affection as a reason for friendship versus instrumentality (the agency or means by which a person accomplishes her/his/their goals or objectives). As Rawlins noted, "This principle formulates the interpenetrated nature of caring for a friend as an end-in-itself and/or as a means to an end."²⁵ We already discussed the importance of affection in a friendship, but haven't examined the issue of friendships and instrumentality. In friendships, the issue of instrumentality helps us understand the following question, "How do we use friendships to benefit ourselves?" Some people are uncomfortable with this question and find the idea of instrumentality very anti-friendship. Have you ever had a really bad day and all you needed was a hug from your best friend? Well, was that hug a sign of affection? Or did you use that friendship to get something you wanted/needed (instrumentality)? We all do this to varying degrees within friendships. Maybe you don't have a washer and dryer in your apartment, so you go to your best friend's place to do laundry. In that situation, you are using your friend and that relationship to achieve a need that you have (wearing clean clothes).

The problem of instrumentality arises when one party feels that he/she/they are being used and taken for granted within the friendship itself or if one friend stops seeing these acts as voluntary and starts seeing them as obligatory. First, there are times when there is an imbalance in friendships, and one friend feels that they are being taken advantage of. Maybe the friend with the washer and dryer starts realizing that the only time their friend really reaches out to see if they're available to hang out is when the friend needs to do laundry. Second, sometimes acts that were initially voluntary become seen as obligatory. In our example, maybe the friend who needs to wash their clothes starts to see what was once a nice, voluntary gesture as an obligation. If this happens, then the use of the washer and dryer becomes part of the rules of the friendship, which can change the dynamic of the relationship if the person with the washer and dryer isn't happy about being used in this way.

Judgment/Acceptance

In our friendships, we expect that these relationships are going to enhance our self-esteem and make us feel accepted, cared for, and wanted. On the other hand, interpersonal relationships of all kinds are marked by judgmental messages. Ronald Liang argued that all interpersonal messages are inherently

evaluative.²⁶ So, how do we navigate the need to be accepted and the reality of being judged? A lot of this is involved in the negotiation of the friendship itself. Although we may not appreciate receiving criticism from others, Liang argues that criticism demonstrates to another person that we value them enough to judge.²⁷ Now, can criticism become toxic? Yes. Maybe you've experienced a friend who criticized everything about you. Perhaps it got to the point where it felt that you needed to change pretty much everything about how you look, act, think, feel, and behave just to be "good enough" for your friend. If that's the case, then that friend is clearly not criticizing you for your betterment but for her/his/their desires.

Expressiveness/Protectiveness

The final interactional dialectic is expressiveness/protectiveness. This dialectic questions the degree to which we want to express ourselves in our friendships while determining how much not to express to protect ourselves. As we discussed earlier in this book, social penetration theory starts with the basic idea that in our initial interactions with others we disclose a wide breadth about ourselves. Still, these are primarily surface level topics (e.g., what's your major, what are your hobbies, where are you from). As time goes on, the number of topics we express decreases, but they become more personal (depth). In a friendship relationship, we have to navigate this breadth and depth in deciding what we express and what we protect.

Ultimately, this is an issue of vulnerability. When we open ourselves up to people and express those deeper parts of ourselves, there is an excellent likelihood that disclosure of these areas could cause greater harm to the individual self-disclosing if the information got out. For example, one of our coauthors had a friendship sour after our coauthor's friend started talking to our coauthor's parents about our coauthor's sexual orientation. Our coauthor saw this as a massive violation of the confidentiality of what was self-disclosed in their friendship. This friend still speaks to our coauthor's parents 20 years later, but our coauthor hasn't spoken to this former friend since the trust was violated. All friendships are an exploration of what can be expressed and what needs to be protected. We all have some friends that we keep at arm's length because we know we need to protect ourselves, since they tend towards being overly chatty or gossipy. At the same time, we have other friends who get to see the real us as we protect less and less of ourselves in those friendships. No one will ever completely know what's going on in our heads, but deep friendships probably come the closest and also make us the most vulnerable.

MINDFULNESS ACTIVITY



In a 2018 survey of readers, the magazine *mindful* explored the qualities of good friendships, "(38%) was a friend's propensity for understanding. Next was 29% for trustworthiness, followed by 13% for compassion. Another 15% of the vote was divided between positivity, generosity, sense of humor, and sharing similar interests and passions. Finally, 5% of respondents named other qualities, such as self-awareness and honesty."²⁸

For this activity, we want you to think about how you can become more mindful of your friendships. Here are three things you can do: be present, try something new, and practice compassion and kindness.²⁹ Think about your friendships and answer the following questions:

1. When you're with your friends, are you truly present, or do you let distractions (e.g., your cell phone, personal problems) get in the way of your interactions?
2. How often do you and your friends do new things, or are you stuck in a rut doing the same activities over and over again?
3. When you're with your friends, are you mindfully aware of your attention, intention, and attitude? If not, what can you do to refocus yourself to be more present?

Key Takeaways

- William K. Rawlins proposed five specific characteristics of friendships: voluntary (friendships are based on an individual's free will), personal (we create our friendships with individuals negotiating what those relationships look like with that other individual), equality (friendships have a sense of balance that makes them appear equal), involvement (both parties have to be mutually engaged in the relationship), and affect (friendships involve emotional characteristics different from other types of relationships).
- Two important communication variables impact friendship formation: communication competence and CA. Individuals who have lower levels of communication competence have fewer opportunities to make friends and actually report lower overall satisfaction with their friendships. Individuals with CA are less likely to engage in interactions with others, so they have fewer opportunities to engage in friendships. Individuals with high levels of CA report having fewer friendships and are more likely to list a family member as her/his/their best friend.
- Rawlins' dialectical approach to communication breaks friendship down into two large categories of dialectical tensions: contextual (private/public & ideal/real) and interactional (independence/dependence, affection/instrumentality, judgment/acceptance, and expressiveness/protectiveness). These dialectical tensions provide friendship scholars a framework for understanding and discussing friendships.

Exercises

- Think about one of your current or past friendships. Examine that friendship using Rawlins' five characteristics of friendships: voluntary, personal, equality, involvement, and affect.
- How has your communication competence or CA impacted your ability to develop friendships? Also, what advice would you give to someone who has low levels of communication competence or high levels of communication apprehension on how to form friendships?
- Think about one of your current or past friendships. Use Rawlins friendship dialectics to analyze this friendship (both contextual and interactional). After analyzing your friendship, what do these dialectical tensions tell you about the nature and quality of this friendship?

10.2 Stages and Types of Friendships

LEARNING

OUTCOMES

1. Differentiate among Rawlins' seven stages of friendships.
2. Evaluate Matthews three basic types of friendships.
3. Compare and contrast healthy and unhealthy friendships.

In Stephen Sondheim and George Furth's musical, *Merrily We Roll Along*, the story follows the careers and friendships of three people trying to make it in New York City. One song in the show has always stuck out because of its insightful message about friendship, "Hey Old Friends." In the musical, three friends Mary, Charlie, and Frank get together after not having seen each other for a while. The purpose of the song is to discuss how some friendships can persist even when we aren't in each other's lives daily. You can see a clip from the rehearsal at the [New York City Center's Encore's](#) production starring Celia Keenan-Bolger (Mary), Colin Donnell (Frank) and Lin-Manuel Miranda (Charley).

In this short song, we learn a lot about the nature of this group's friendship and their enduring desire to be close to one another through the ins and outs of life. This section of the chapter is going to examine the stages that friendships through, the types of friendships we have, and healthy vs. unhealthy friendships.

Stages of Friendships

As we've already discussed, friendships are not static relationships we're born with. Instead, these relationships are dynamic, and we grow with them. To help us understand how we ultimately form friendships, William Rawlins broke this process into seven stages of friendships (Figure 10.3).³⁰

Role Delimited Interaction

The first stage of friendship is called role delimited interaction. The basic idea behind this stage is that we all exist in a wide range of roles within our lives: shopper, salesperson, patient, driver, student, parent/guardian, spouse, etc. In each of these different roles, we end up interacting with a wide range of different people. For example, imagine you're just sitting down in a new class in college, and you talk to the stranger sitting next to you named Adilah. In this case, you are both interacting within your roles as students. Outside of those roles and that context, you may never meet and never have the opportunity even to develop a social relationship with this other person.



Figure 10.3. Stages of Friendship

This does not discount the possibility of random, chance encounters with other people. Still, most of our interpersonal relationships (outside of our family) stem from these roles and the communicative contexts they present.

Friendly Relations

From role delimited interaction, we may decide to move to the second stage of friendship, friendly relations. These relations are generally positive interactions, but they still exist within those same roles. In our example, we start chatting with Adilah before the beginning of each class. At this point, though, most of our interactions are still going to be within those roles, so we end up talking about the class, fellow students, the teacher, homework assignments, etc. Notice that there is not a lot of actual self-disclosure happening within friendly relations. Some people can maintain friendly relations with others for years. For example, you may interact with coworkers, religious association members, and neighbors within this type of relationship without them ever progressing to the next stage of friendship. According to Rawlins, friendly relationships move towards friendships because they start to exhibit four specific communication behaviors:

1. moves away from what is required in the specific role relationship,
2. fewer stereotyped lines of interaction,
3. individual violations of public propriety, and
4. greater spontaneity.³¹

First, we start interacting in a manner that doesn't resemble the original roles we had. In our example, we start interacting in a manner that doesn't resemble the roles of students when they first meet. Second, we move away from lines of communication that are stereotypes for our roles. For example, some possible stereotyped lines for two students could include, "what did you think of the homework;" "did you bring your book with you today;" "see you next class;" etc. In each of these lines, we enact dialogue that is expected (or stereotyped) within the context of the class itself. Third, more of our normal selves will start to seep into our interactions, which are called violations of public propriety. Maybe one day Adilah turns to you before class, saying, "That reading for homework was such a waste of time." In this case, Adilah is giving you a bit more insight into who she is as a person "These violations of public propriety single an individual out as having an essential side which is not so easily circumscribed by the protocol of a situation."³² Lastly, we see increased spontaneity in our interactions with the other person. Over time, these interactions, although still interacting within their formal roles, take on more social and less formalized tones. Maybe one day Adilah tells you a joke or shares a piece of gossip she heard. In this case, Adilah is starting to be more spontaneous and less structured in her interactions.

Moves-Toward-Friendship

At some point, people decide to interact with one another outside of the roles they originally embodied when they initially met. This change in roles is a voluntary change. In our example, maybe one day Adilah invites you to get coffee after class, and then another day, you ask her to get lunch before class. Although it's possible that a single step outside of those roles could be enough that a friendly relation is moving towards a friendship, there is generally a sequence of these occurrences. In our example here, Adilah may have made the first move inviting us to coffee, but we then reciprocated later by asking her to lunch. In both of these cases, we are starting to step outside of the original friendly relation and changing

the nature of our original interactions.

Nascent Friendship

When one enters into the nascent stage of friendship, the friends are no longer interacting within their original roles, and their interactions do not follow the stereotypes associated with those roles. Eventually, we start to develop norms for how we communicate with this other person that are beyond those original roles and stereotypes. Ultimately, this stage is all about developing those norms. We develop norms for what we talk about, when we talk, and how we talk. Maybe Adilah makes it very clear that she doesn't want to talk about politics or religion, and we're perfectly OK with that. Maybe we keep the bulk of our interaction before and after class, or we start having lunch together before class or coffee after class. The norms will differ from friendship to friendship, but these norms allow us to set parameters on the relationship in this early stage. These norms are also important because keeping them demonstrates that we can be trusted. And when we show we can be trusted over time, the level of intimacy we can develop within our relationship also increases.

It's also during this period that others start to see you more and more as a pair of friends, and external forces may begin to impact the development of your friendship as well. In our case, maybe Adilah has a sister who also goes to the school, so she starts hanging out with both of you from time to time. Maybe we have a significant other, and he/she/they start hanging out as well. Even though we may have these distractions, we must keep faithful to the original friendship. For example, if we start spending more time with Adilah's sister than Adilah, then we aren't faithful to the original friendship. Eventually, the friendship crystalizes, and others start to see the two friends as a pair. One of our coauthors had a friend in graduate school, and it was very common for people to ask the friend when our coauthor couldn't be found or ask the coauthor when the friend couldn't be found. Friends in the nascent state are seen increasingly as a "duo."

Stabilized Friendship

Ultimately nascent friendships evolve into stabilized friendships through time and refinement. It's not like one day you wake up and go, "My friendship has stabilized!" It's much more gradual than that. We get to the point where our developed norms and interaction patterns for the friendship are functioning optimally for both parties, and the friendship is working smoothly. In nascent friendships, the focus is on the duo and developing the friendship. In stabilization, we often bring in new friends. For example, if we had found out that Adilah had coffee with another person from our class during the nascent stage of friendship, we may have felt a bit hurt or jealous of this outsider intruding on our growing friendship. As stabilized friends, we realize that Adilah having coffee with someone else isn't going to impact the strength of the relationship we already have. If anything, maybe Adilah will find other friends to grow the friendship circle. However, like any relationship, both parties still must make an effort to make the friendship work. We need to reaffirm our friendships, spend time with our friends, and maintain that balance of equity we discussed earlier in this chapter.

Rawlins also notes that friendships in the stabilized stage can represent three different basic patterns: active, dormant, and commemorative.³³ **Active friendships** are ones where there is a negotiated sense of mutual accessibility and availability for both parties in the friendship. **Dormant friendships** "share either a valued history or a sufficient amount of sustained contact to anticipate or remain eligible for a resumption of the friendship at any time."³⁴ These friends may not be ones we interact with every day, but they are still very much alive and could take on new meaning and grow back into an active friendship

if the time arises. **Commemorative friendships** are ones that reflect a specific space and time in our lives, but current interaction is minimal and primarily reflects a time when the two friends were highly involved in each other's lives. With commemorative friendships, we still see ourselves as friends even though we don't have the consistent interaction that active friendships have.

In a study conducted by Sara LaBelle and Scott Myers, the researchers set out to determine what types of relational maintenance strategies people use to keep their friendships going across the three different types of friendship patterns (active, dormant, & commemorative).³⁵ Using the seven relational maintenance behaviors noted by Laura Stafford (positivity, understanding, self-disclosure, relationship talks, assurances, tasks, & networks),³⁶ the researchers recruited participants over the age of 30 to examine the intersection of relational maintenance and friendship types. All three friendship types use positivity, relational talks, and networks related to relational maintenance to some degree. However, active friendships were more likely than commemorative friendships to use understanding, self-disclosure, assurances, and tasks to maintain their friendships. No differences were seen in relational maintenance strategies between active and dormant friendships nor dormant friendships and commemorative friendships.

Waning Friendship

Unfortunately, some friendships will not last. There are many reasons why friendships may start to wane or decrease in importance in our lives. There are three primary reasons Rawlins discusses as causes: "an overall decline in affect, an individual or mutual decision to let it wane based on identifiable dissatisfaction with the relationship, or a significant, negative, relational event which precipitates an abrupt termination of the friendship."³⁷ First, some relationships wane because there is a decrease in emotional attachment. Some friends stop putting in the time and effort to keep the friendship going, so it's not surprising that there is a decrease in emotional attachments. Second, both parties may become dissatisfied with the relationship and decide to take a hiatus or spend more time with other friends. Lastly, some relationship-destroying event could happen. For example, you find out that Adilah had an affair with your romantic partner. Adilah broke a promise to you or told someone one of your secrets. Adilah started yelling at you for no reason and physically assaulted you. Each of these events would most likely destroy your friendship.

A wide range of different events could end a friendship. In a study conducted by a team of researchers led by Amy Janan Johnson, the researchers interviewed college students about why their friendships had terminated.³⁸ The most common reasons listed for why relationships fell apart were 1) romantic partner of self or friend, 2) increase in geographic distance, 3) conflict, 4) not many common interests, 5) hanging out with different groups or different friends, and 6) other. Interestingly, females and males in the study did report differences in the likelihood that these five reasons led to deterioration. Females reported that conflict was a greater reason for friendship deterioration than males. And males reported not having many common interests was a greater reason for friendship deterioration than females. Females and males did not differ in the other three categories. It's important to note, that while this set of findings is interesting, it was conducted among college students, so it may not apply to older adults.

Post-Friendship

The final stage of the friendship is what happens after the friendship is over. Even if a friendship ended on a horrible note, there are still parts of that friendship that will remain with us forever, impacting how

we interact with friends and perceive friendships. You may even have symbolic links to your friends: the nightclubs you went to, the courses you took together, the coffee shops you frequented, the movies you watched, etc. all are links back to that friendship. It's also possible that the friendship ended on a positive note and you still periodically say hello on Facebook or during the holidays through card exchanges. Just as all friendships are unique, so are their experiences of post-friendship reality.

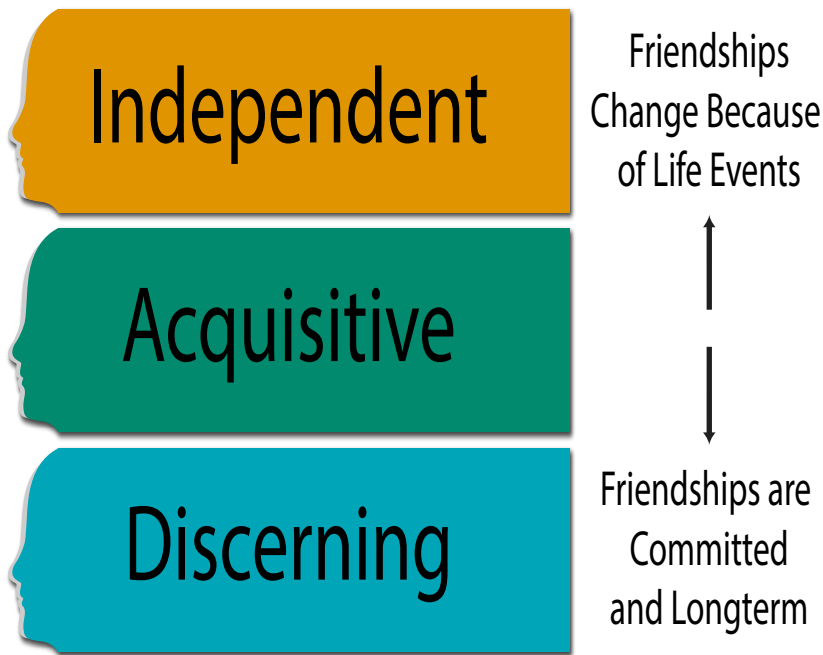

Figure 10.4 Friendship Styles

Friendship Styles

Beyond the stages of friendship development, different people develop different types of friendship throughout their lifetime. Sarah H. Matthews noted that ultimately people have three basic types of friendships: independent, discerning, and acquisitive (as seen in Figure 10.4).³⁹

Independent

In her study, Matthews found that independents often saw their friendships based on specific circumstances in their lives and not necessarily specific friends. When talking about friends, independents were more likely to about

“people they knew” or “people they had known,” not reflecting on specific names. Independents were more likely to mention specific names when they talked about people they were interacting with currently. For example, independents talked about friends during periods of their life (e.g., elementary school, junior high/middle-school, high school, college) and not about specific people they knew for long periods of life. Matthews argues that independents framed their concepts of friendships regarding major life events. They also never reported having a close, special, or best friend relationship, so during periods of major life events, they didn't have specific commitments to the people they called “friends.” Independents were also more likely to talk about friends as a general concept instead of specific friends. Comparing independents to the stages of friendship discussed by Rawlins, you can consider these to be more along the lines of “friendly relations.” Matthews chose the term “independents” because it reflects a more autonomous state, “It was clear that most of them were not isolated people, but instead considered themselves to be sufficient unto themselves.”⁴⁰

Discerning

The second type of friendship discussed by Matthews was the discerning style, which, unlike independents, is marked by a deep connection with a friend or group of friends regardless of changing circumstances in their lives. These friendships are marked by deep commitment and longevity, which also means that when a discerning person loses a friend, they are the most likely to experience a deep sense of loss in their lives. Discerners were also more likely to draw clear lines between friendly relations and friendship. Overall, “the discerning identified ... only a very few people throughout their lives whom

they considered friends. Although not all of these informants had kept these friendships, those who had, valued them highly.”⁴¹

Acquisitive

The final friendship style discussed by Matthews is the acquisitive style. Acquisitives are “people who moved through their lives collecting a variety of friendships, allowing circumstances to make possible the meeting of likely candidates, but then, committing themselves to the friendships once they were made, at the very least for the period of time during which they and their friends were geographically proximate.”⁴² Unlike the independents, acquisitives discussed having close connections with all of the friends they’ve met, and unlike the discerning, acquisitives were open to developing new friendships throughout their lives. In essence, these individuals develop a strong, core group of friends as they go throughout their lives while acquiring new ones depending on changes within their lives.

Good and Bad Friendships

Another system for understanding friendships is to think of them with regard to two basic psychological constructs: health and enjoyment. First, is the relationship a healthy one for you to have? Although this is a concept that is more commonly discussed in romantic relationships, friendships can also be healthy or unhealthy (Table 10.2).

Healthy	Unhealthy
Mutual respect	Contempt
Trust	Suspicion
Honesty	Untruthful
Support	Hinder
Fairness/Equality	Unjust/Inequity
Separate Identities	Intertwined Identities
Open Communication	Closed Communication
Playfulness/Fondness	Sober/Animus
Self-Esteem Enhancing	Self-Esteem Destroying
Fulfilling	Depressing
Acceptance	Combative
Affectionate/Loving	Cold/Indifferent
Comforting	Stressful
Genuine/Benevolent	Manipulative/Exploitive
Beneficial	Damaging
Healthful	Toxic

Table 10.2 Healthy vs. Unhealthy Friendships

In addition to the health of a friendship, you must also question if the friendship is something that is ultimately enjoyable to you as a person. Does this friendship give you meaning of some kind? Ultimately, we can break this down into four distinct types of friendship experiences people may have (Figure 10.5).

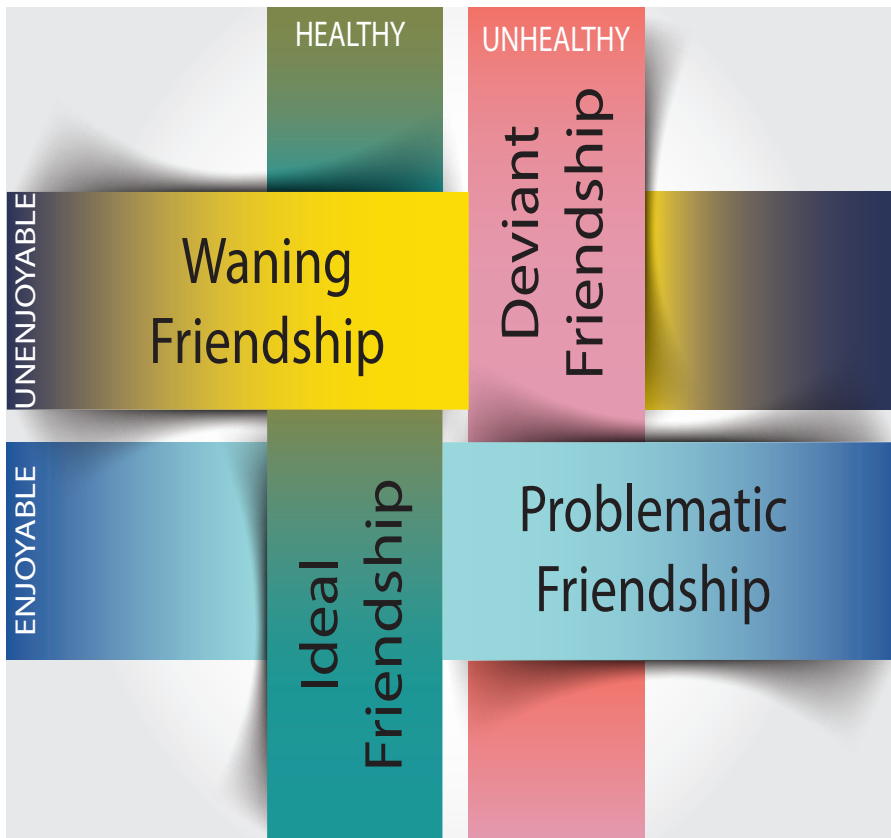

Ideal Friendship

The first category we label as “ideal friends” because these relationships are both healthy and enjoyable. In an ideal world, the majority of our relationships would fall into the category of ideal friendships.

Waning Friendship

The second category we label as “waning friendship” because these friendships are still healthy but not enjoyable anymore. Chances are, this friendship was an ideal friendship at some point and has started to become less enjoyable over time. There’s a wide range of reasons why friendships may stop being enjoyable. It’s possible that you no longer have the time to

invest in the friendship, so you find yourself regretting the amount of time and energy that’s necessary to keep the friendship afloat.

Problematic Friendship

The third category of friendship, classified as problematic friendships, is tricky because these are enjoyable but not healthy for us. Ultimately, the friend we have could be a lot of fun to hang out with, but they also could be more damaging to us as people. Instead of supporting us, they make fun of us. Instead of treating us as equals, they hold all the power in the relationship. Instead of being honest, we always know they’re lying to us. Ultimately, we must question why we decide to stay in these relationships.

Deviant Friendship

The final category of friendships we may have is deviant friendships, more commonly referred to as toxic friendships. For our purposes here, we use the term “deviant” because it refers to any behavior that violates behavioral norms. In this case, any friendship situation that is clearly outside the parameters of what is a healthy and enjoyable friendship is not the norm. Unfortunately, some people get so stuck in these friendships that they stop realizing that these friendships aren’t normal at all. Other people may think that their deviant friendships are the only kinds of friendships they can get and/or deserve. It’s entirely possible that a deviant friendship started as perfectly healthy and normal, but often these were somewhat problematic in their early stages and eventually progressed into fully deviant friendships.

Deviant Friends:

- Use criticism and insults as weapons
- Use guilt to get you to cave-in to their desires and whims
- Immediately assume you're lying (probably because they are)
- Disclose your personal secrets
- Are very gossipy about others, and are probably gossipy about you as well
- Only care about their own desires and needs
- Use your emotions as weapons to attack you psychologically
- Pass judgment on you and your ideas based on their own with little flexibility
- Are stuck up and only really turn to you when they need you
- Can be obsessively needy, but then are very hard to please
- Are inconsistent, so predicting how they will think or behave can be very hard if not impossible
- Put you in competition with their other friends for affection and attention
- Conversations tend to be all about them and their desires and needs
- Make you feel that being your friend is a chore for them
- Make you feel as if you've lost control over your own life and choices
- Cross major relationship boundaries and violate relationship norms without apology
- Express their jealousy of your other friendships and relationships

Key Takeaways

- Rawlins proposed that friendships go through seven distinct stages. The first stage, role delimited interaction, is where we interact with a broad range of people within specific roles we play in life. The second stage, friendly relations, occurs when we have continuous positive interactions with someone, but the interactions still exist within those same roles. The third stage, moves-toward-friendship, occurs when people decide to interact with one another outside of the roles they originally embodied when they initially met. The fourth stage, nascent friendship, occurs when the friends are no longer interacting within their original roles, and their interactions do not follow the stereotypes associated with those roles. The fifth stage, stabilized friendship, reflects friendships that have developed norms and interaction patterns that are functioning optimally for both parties, and the friendship is working smoothly. The sixth stage, waning friendship, occurs when a friendship decreases in importance in our lives. The final stage, post-friendship, occurs after a friendship has been terminated.
- Sarah H. Matthews proposed three basic types of friendships that people have: independent, discerning, and acquisitive. Independents see friendships based on specific circumstances in their lives and not necessarily on specific friends. Discerning friendships are marked by a deep connection with a friend or group of friends regardless of changing circumstances in their lives. Lastly, acquisitive individuals develop a strong, core group of friends as they go throughout their lives while acquiring new ones depending on changes within their lives.
- To understand healthy versus unhealthy friendships, it's also important to consider whether an individual finds that relationship enjoyable or unenjoyable. People who are in a healthy and enjoyable friendship are in an ideal friendship. Individuals who are in a healthy friendship that is unenjoyable are in a waning

friendship. People who are in unhealthy friendships that are enjoyable are in a problematic friendship. Lastly, people who are in unhealthy friendships that are unenjoyable are in a deviant friendship.

Exercises

- Think back on a friendship that you no longer have. Take that friendship through all seven of Rawlins' friendship stages. How did you decide when the friendship entered into a new stage?
- Think about your patterns of friendships in your life. Based on the information you learned from Matthews, what type of friendship style do you have? What made you decide that this friendship style most accurately reflects your approach to friendships?
- Thinking about the intersection of healthy friendships and enjoyability, think of one friendship from your own life (past or present) that fits into each category. After coming up with four friendships, differentiate among the four friendships and their outcomes.

10.3 Friendships in Different Contexts

LEARNING OUTCOMES

1. Differentiate between same-sex and opposite sex friendships.
2. Evaluate J. Donald O'Meara five distinct challenges that opposite-sex relationships have.
3. Define and explain the term "postmodern friendship."
4. Appraise the importance of cross-group friendships.
5. Interpret the impact that mediated technologies have on friendships.

So far in this chapter, we've explored the foundational building blocks for understanding friendships. We're now going to break friendships down by looking at them in several different contexts: gender and friendships, cross-group friendships, and mediated friendships.

Gender and Friendships

Based on a more traditional differentiation of both same and opposite sex friendships, early friendship research divided friendships into two categories communal and agentic. Communal friendships were marked by intimacy, personal/emotional expressiveness, amount of self-disclosure, quality of self-disclosure, confiding, and emotional supportiveness.⁴³ Agentic friendships, on the other hand, were activity-centered. Figure 10.6 illustrates three curves associated with these concepts. The first one shows women being communal and men being agentic in their friendships, which was a common perspective on

the nature of gender differences and friendships. In reality, research demonstrated that both males and females can have communal relationships even though women report notably higher levels of communality in their friendships (second set of curves). As for agency, women and men were found to both have agentic friendships, and there was considerable overlap between the two groups here, with men being slightly more agentic (seen in the third set of curves).

A great deal of research in friendship has focused on sex differences between males and females with regard to friendship. In this section, we're going to start by looking at some of the research specifics to same-sex friendships and then opposite sex friendships. We'll end this section discussing a different way of thinking about these types of relationships.

Same-Sex Friendships

For a lot of research, we use the term "same-sex" to refer to two individuals of the same biological sex as friends. Gerald Phillips and Julia Wood argue that there are four primary reasons females develop friendships with the same-sex: activities, personal support, problem-solving, and reciprocation.⁴⁴ For female same-sex friendships, the first reason is activity. These are friendships that tend to develop around a specific activity: working out, church, social clubs, etc. For the most part, these friendships stay confined to the activity itself and provide a chance for conversation and noncommittal associations. The second reason is personal support. It's this second category that many highlight when discussing the differences between female and male friendships. Personal support involves friendships where an individual has a personal confidant with whom they can share their deepest, darkest secrets, concerns, needs, and desires. These friendships are often highly stable friendships and tend to last for a long time. By nature, these friendships tend to be highly communal, which is why we generally discuss them as a key reason for female same-sex friendships. Third, all of us have areas where we're skillful and lack skill. We often develop friendships with people who have skills that are complementary to our own. Consciously or subconsciously, we develop friendships with others out of a need to problem-solve in our daily lives. For example, an information technology specialist may become friends with an accountant. In their friendship, they provide complementary support: computer help and financial advice. Finally, females tend to view their friendships as highly reciprocal. They expect to get out of a friendship what they put into a friendship; it's a mutual exchange. If a female feels her friend is not putting into a relationship the same amount of time and energy, she is less likely to keep sustaining that friendship.

As for male-male friendships, research shows us that they're not drastically different, though their friendships may be framed differently. They still create friendships because of recreation, personal

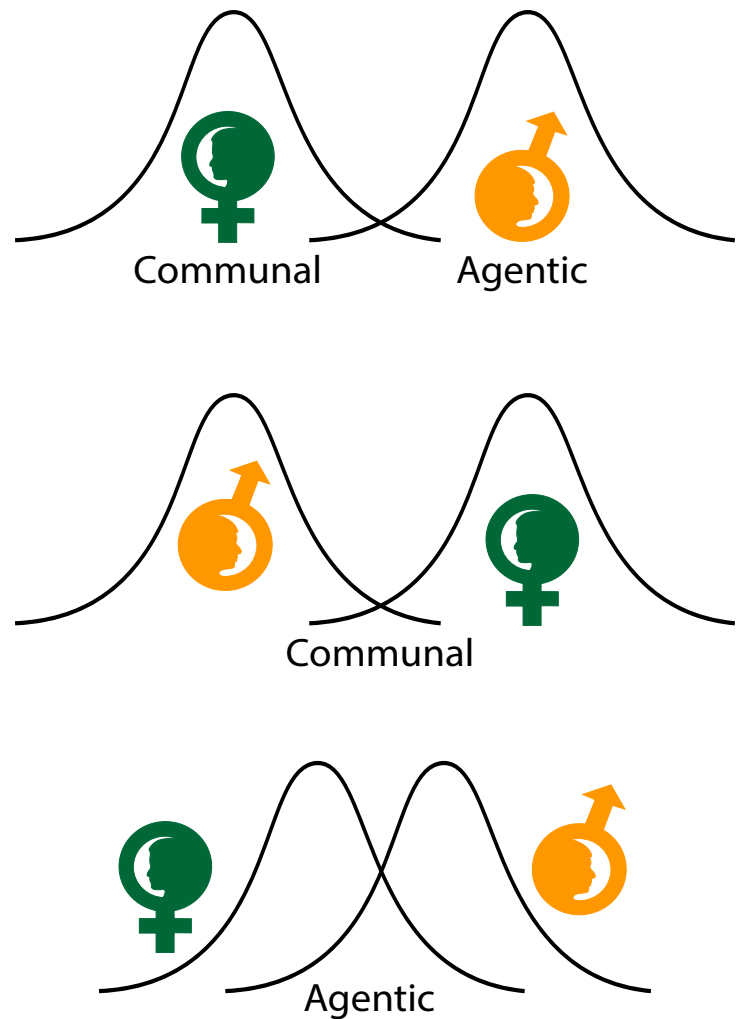

Figure 10.6. Communal vs. Agentic

support, problem-solving, and reciprocation. And these relationships can be just as intimate as their female counterparts, but the relationships may look a bit more distinct. First, many male friendships are based around activities: church, work, hobbies, social clubs, etc. These friendships are less about having conversations and more about engaging in the activity at hand. These friendships are not going to be as communal as female friendships that develop around recreation. Often people mistake these male friendships as being less “intimate” because they do not disclose a lot of information, and there isn’t necessarily a lot of talk involved, but males do find these relationships perfectly fulfilling.

Phillips and Woods noted that men often view friendships in terms of teams; having allies and team members. In essence, they create their tight-knit circles of in and out-group members based on “team” status. Part of this team status involves performing favors for each other and siding with one another. It’s the whole “I’ve got your back” mentality. We should also note that males are more likely to be friends with those who are the most like them: similar majors, similar religion, similar rungs of the social hierarchy, similar socioeconomic status, similar attitudes, similar interests, etc. Research has even shown that males are more likely to have male friends who are equally physically attractive.⁴⁵ One possible explanation for this phenomenon is that males are more likely to develop relationships based on social hierarchies. If attractive males are on a higher rung of a social hierarchy, then it’s not surprising that the matching effect occurs.⁴⁶

Opposite Sex Friendships

“Friendship between a woman and a man? For many people, the idea is charming but improbable.”⁴⁷ William Rawlins originally wrote this sentence in 1993 at the start of a chapter about the problems associated with opposite sex or opposite-sex friendships. What do you think? J. Donald O’Meara discusses five distinct challenges that opposite-sex relationships have: emotional bond, sexuality, inequality and power, public relationships, and opportunity structure.^{48,49}

Emotional Bond

First and foremost, in Western society females and males are raised to see the opposite sex as potential romantic partners and not friends. One of the inherent problems with opposite-sex friendships is that one of the friends may misinterpret the friendship as romantic. From an emotional sense, the question that must be answered is how do friends develop a deep-emotional or even loving relationship with someone of the opposite sex. Unfortunately, females are more likely than males to think this is possible. William Rawlins did attempt to differentiate between five distinct love styles that could help distinguish the types of emotional bonds possible: friendship, Platonic love, friendship love, physical love, and romantic love.⁵⁰ First, friendship is “a voluntary, mutual, personal and affectionate relationship devoid of expressed sexuality.”⁵¹ Second, Platonic love is an even deeper sense of intimacy and emotional commitment without sexual activity. Third, friendship love is the interplay between friendships and sexual relationships. It’s often characterized by the use of the terms “boyfriend” and “girlfriend” as distinguishing characteristics to denote paired romantic attachments. Fourth, physical love tends to involve high levels of sexual intimacy with low levels of relationship commitment. And finally, there’s romantic love, or a relationship marked by exclusivity with regards to emotional attachment and sexual activity. O’Meara correctly surmises that the challenge for opposite-sex friendships is finding that shared sense of love without one partner slipping into one of the other four categories of love because often the emotions associated with all five different types of love can be perceived similarly.

Sexuality

The obvious next step in the progression of issues related to opposite-sex friendships is sexuality. Sexual attraction is inherent in any opposite-sex friendship between heterosexual couples. Sexual attraction may not be something initial in a relationship. Still, it could develop further down the line and start to blur the lines between someone's desire for friendship and a sexual relationship. In any opposite-sex friendship, there will always be a latent or manifested sexual attraction that is possible. Even if one of the parties involved in the friendship is completely unattracted to the other person, it doesn't mean that the other friend isn't sexually attracted. As such, like it or not, there will always be the potential for the issue of sexuality in opposite-sex friendships once people hit puberty. Now it's perfectly possible that both parties within a friendship are mutually sexually attracted to each other and decide openly not to explore that path. You can find someone sexually attractive and not see them as a viable sexual or romantic partner. For example, maybe you both decide not to consider each other viable sexual or romantic partners because you're already in healthy romantic relationships, or you may realize that your friendship is more important.

Inequality and Power

We live in a society where men and women are not treated equally. As such, a fact of inequality and power-imbalance, created by our society, will always exist between people in opposite-sex friendships. As such, males are in a better position to be in an exchange relationship. O'Meara argues that opposite-sex friendships should, therefore, strive to develop communal ones. However, there is also an imbalance that may exist when it comes to communal needs as well. Females are more likely to get their emotional needs through same-sex friendships. However, males are more likely to get their emotional needs met through opposite sex friendships. This dependence on the opposite sex for emotional needs and support places females in a subordinate position of needing to fulfill those needs.

Public Relationships

The next challenge for opposite-sex friendships involves the public side of friendships. The previous three challenges were all about the private inner workings of the friendship between a female and a male (internal side). This challenge is focused on public displays of opposite-sex friendships. First, it's possible that others will see an opposite-sex friendship as a romantic relationship. Although not a horrible thing, this could give others the impression that a pair of friends are not available for romantic relationships. If one of the friends is seen on a date, other could get the impression that the friend is clearly cheating on their significant other. Second, it's possible that others won't believe the couple as "simply being friends." This consistent devaluing of opposite-sex friendships and the favoring of opposite-sex romantic relationships in our society puts a lot of stress on opposite-sex friendships. Devaluing of friendships over romantic relationships can also be seen as a tool to delegitimize opposite-sex friendships. Third, it's possible that others may question the sexual orientation of the individuals involved in the opposite-sex friendship. If a male is in a friendship relationship with a female, he may be labeled as gay or bisexual for not turning that opposite-sex friendship into a romantic one. The opposite is also true. Lastly, public opposite-sex friendships can cause problems for opposite-sex romantic partners. Although not always the case, it may be very difficult for one member of a romantic relationship to conceive that their partner is in a close friendship relationship with the opposite sex that is not romantic or sexual. For individuals who have never experienced these types of emotional connections, they may assume that it is impossible

and that the opposite-sex friends are just “kidding themselves.” Another possible problem for romantic relationships is that the significant other becomes jealous of the opposite-sex friend because they believe that, as the significant other, they should be fulfilling any role an opposite-sex friend is.

Scouts are Changing with the Times

Just as a quick caveat, as of the publication of this book, the Girl Scouts of America is open to transgendered children on a case-by-case basis. However, Boy Scouts of America started accepting girls starting in 2017 and is now called Scouts BSA to show this change to policy.

Opportunity Structure

The final challenge described by O’Meara was not part of the original four but was described in a subsequent article.⁵² This question is primarily focused on how individuals find opportunities to develop opposite-sex friendships. A lot of our social lives are divided into females and males. Girls go to Girl Scouts and Boys to Boy Scouts. Girls play volleyball and softball while boys play football and baseball. Now, that’s not to say that there aren’t girls who play football or boys who play volleyball, but most of these sports are still highly sex-segregated. As such, when we’re growing up, we are more likely to spend social time with the same-sex. Ultimately, it’s not impossible for opposite-sex relationships to develop, but our society is not structured for these to happen naturally in many ways.

Postmodern Friendships

In the previous section, we looked at some of the basic issues of same-sex and opposite-sex friendships; however, a great deal of this line of thinking has been biased by heteronormative patterns of understanding.⁵³ The noted absence of LGBTQIA+ individuals from a lot of the friendship literature is nothing new.⁵⁴ We have needed newer theoretical lenses to help us break free of some of these historical understandings of friendship. “Growing out of poststructuralism, feminism, and gay and lesbian studies, queer theory has been favored by those scholars for whom the heteronormative aspects of everyday life are troubling, in how they condition and govern the possibilities for individuals to build meaningful identities and selves.”⁵⁵ By taking a purely heteronormative stance at understanding friendships, friendship scholars built a field around basic assumptions about gender and the nature of gender.⁵⁶

Friendship scholar Michael Monsour asked a group of friendship scholars about the definition of “friendship” and found there was little to no consensus. How then, Monsour argues, can researchers be clear in their attempts to define “gender” and “sex” when analyzing same-sex or opposite sex friendships?⁵⁷ As part of his discussion questioning the nature of gender and sex and they have been used by friendship scholars, Monsour provided the following questions for us to consider:

- What does it mean to state that two individuals are in a same-sex or opposite sex friendship and/or that they are of the same or opposite sex from one another?
- What decision rules are invoked when deciding whether a particular friendship is one or the other?
- Why must the friendship be one or the other?
- If friendship scholars and researchers believe that all friendships are either same-sex or opposite-

sex (and it appears that most do), at a minimum there should be agreement about what constitutes biological sex. What biological traits make a person a female or a male?

- Are they absolute?
- Are they universal?⁵⁸
- As part of this discussion, Monsour provides an extensive list of areas of controversy related to the terms used for binary gender identity.
- What about individuals who are intersexed?
- What about individuals with chromosomal differences outside of traditional XX and XY (e.g., X, Y, XYY, XXX, XXY)? Heck, there are even some XXmales and XYfemales who develop because of chromosomal structural anomalies SRY region on the Y chromosome?
- What about bisexual, gay, and lesbian people?
- What about people who are transgendered?
- What about people who are asexual?

Hopefully, you're beginning to see that the concept of labeling "same-sex" and "opposite sex" friendships based on heterosexual cisgendered individuals who have 46-chromosomal pairs that are either XX or XY may not be the best or most complete way of understanding friendship.

We should also note that research in the field of communication has noted that an individual's biological sex contributes to maybe 1% of the differences between "females" and "males."⁵⁹ So, why would we use the words "same" and "opposite" to differentiate friendship lines when there is more similarity between groups than not? As such, we agree with the definition and conceptualization of the term created by Mike Monsour and William Rawlins' "postmodern friendships."⁶⁰ A **postmodern friendship** is one where the "participants co-construct the individual and dyadic realities within specific friendships. This co-construction involves negotiating and affirming (or not) identities and intersubjectively creating relational and personal realities through communication."⁶¹ Ultimately, this perspective allows individuals to create their own friendship identities that may or may not be based on any sense of traditional gender identities.

Cross-Group Friendships

As we noted above, research has found that one of the biggest factors in friendship creation is the groups one belongs too (more so for males than females). In this section, we're going to explore issues related to cross-group friendships. A cross-group friendship is a friendship that exists between two individuals who belong to two or more different cultural groups (e.g., ethnicity, race, sexual orientation, socioeconomic status, nationality). "The phrase, 'Some of my best friends are...' is all too typically used by individuals wanting to demonstrate their liberal credentials. 'Some of my best friends are ... gay.' 'Some of my best friends are ... Black.' People say, 'Some of my best friends are ...' and then fill in the blank with whatever marginalized group which they care to exonerate themselves."⁶² Often when we hear people make these "Some of my best friends are..." statements, we view them as seriously suspect and question the validity of these relationships as actual friendships. However, many people develop successful cross-group friendships.

It's important to understand that our cultural identities can help us feel that we are part of the "in-group" or part of the "out-group" as well. Identity in our society is often highly intertwined with marginalization. As noted earlier, we also know that males are more likely to align themselves with others they perceive as similar. Females do this as well, but not to the same degree as males. In essence, most

of us protect our group identities by associating with people we think are like us, so it's not surprising that most of our friendships are with people who are demographically and ideologically similar to us. To a certain extent, we judge members of different out-groups based on our ethnocentric perceptions of behavior. For example, some people ask questions like, "Why does my Black friend talk about race so much?"; "Does my friend have to act 'so' gay when we're in public?"; or "I like my friend, but does she always have to talk to me about her religion?". In these three instances (race, sexual orientation, and religion), we see examples of judging someone's communicative behavior based on their own in-group's communicative behavioral norms. Especially for people who are marginalized, being marginalized is a part of who they are that cannot be separated from how they think and behave. Maybe a friend talks about race because they are part of a marginalized racial group, so this is their experience in life. "This is actually normal and understandable behavior on the part of these different groups. They are not the ones who make it the focus of their lives. Society—the rest of us—makes race or orientation or gender an issue for them—an issue that they cannot ignore, even if they wanted to. They have to face it every waking moment of their lives."⁶³ People who live their lives in marginalized groups see this marginalization as part of their daily life, and it's intrinsically intertwined with their identity.

Many of us will have the opportunity to develop cross-group friendships throughout our lives. As our society becomes more diverse, so does the likelihood of developing cross-group friendships. In a large research project examining the outcomes associated with cross-group friendships, the researchers found two factors were the most important when it came to developing cross-group friendships: racism and exposure to cross-group friendships. First, individuals who are racist are less likely to engage in cross-group friendships.⁶⁴ Second, actual exposure to cross-group friendships can lead to more intergroup contact and more positive attitudes towards members in those groups. Ultimately, successful cross-group friendships succeed or fail based on two primary factors: time and self-disclosure.⁶⁵

First, successful cross-group friendships take time to develop, so don't expect them to happen overnight. Furthermore, these relationships will take more time to develop as you navigate your cultural differences in addition to the terms of the friendship itself. It's important that when we use the word "time" here, we are not only discussing both longitudinal time, but also the amount of time we spend with the other person. The more we interact with someone from another group, the stronger our friendship will become.

Second, successful cross-group friendships involve high amounts of self-disclosure. We must be open and honest with our thoughts and feelings. We need to discuss not only the surface level issues in our lives, but also have deeper, more meaningful disclosures about who we are as individuals and who we are as individuals because of our cultural groups. One of our coauthor's best friend is from a different racial background. Our coauthors grew up in the Southern part of the United States, and our coauthor's friend grew up in the inner-city area in Los Angeles. When they met, they had very different lived experiences related to both race and geographic differences. Their connection was almost instantaneous, but the friendship grew out of many long nights of conversations over many years.

Mediated Friendships

Probably nothing has more radically altered the meaning of the words "friend" and "friendship" than widespread use of social technology. Although the Internet has been around since 1969 and was consistently used for the exchange of messages through the 1990s, the public didn't start to become more actively involved with the technology until it became cheap enough to use in one's daily life. Before December 1996, using the "information superhighway" was limited to tech professionals, colleges and

universities, the government, and hobbyists. The pricing model for Internet use had been similar to that of a telephone subscription. You paid a base rate that allowed you so many hours each month (usually 10) of connected Internet time, and then you paid an additional rate for each subsequent hour. People who were highly active on the Internet racked up enormous bills for their use. Of course, this all changed in December 1996 when America Online (AOL) decided to offer unlimited internet access to the world for \$19.95 per month. This change in the pricing structure ultimately led to the first real wave of people jumping online because it was now economically feasible.

The Internet that we all know and love today looks nothing like the web-landscape of the late 20th Century. So much has changed in the first 20 years of the new millennium in technology and how we use it to interact with your friends and family. For our purposes, we're going to focus on the issue of mediated friendships in this section. We'll discuss computer-mediated communication, in general, in Chapter 12.

In the earliest days of online friendships, technology was commonly used to interact with people at larger geographic distances. You met friends in chatrooms or on bulletin boards (precursors to modern social media), and most often, these people were not ones in your town, state, or even country. By 2002, 72% of college students were interacting with their friends online.⁶⁶ This was the same year Friendster was created, the year before MySpace came into existence, and a solid two years before Facebook was created (February 4, 2004). So, most interaction in 2002 was through email, instant messaging, and chat rooms. Today we talk less about using the Internet and more about what types of applications people are using on their smartphones (the first iPhone came out on June 29, 2007). For example, in 2018, 68% of U.S. adults used Facebook. By comparison, 81% of adults 18 to 29 use Facebook, while only 41% of U.S. adults over the age of 65 are using Facebook.⁶⁷ What about other common apps? Statistics show that, among US adults, 73% use YouTube, 35% use Instagram, 29% use Pinterest, 27% use Snapchat, 25% use LinkedIn, 24% use Twitter, and 22% use WhatsApp.⁶⁸

All of these different technologies have enabled us to keep in touch with each other in ways that didn't exist at the beginning of the 21st Century. As such, the nature of the terms "friend" and "friendship" have changed. For example, how does one differentiate between a friend someone has primarily online and a friend someone sees face-to-face daily? Does the type of technology we use help us explain the nature of our friendships? Let's explore both of these questions.

What's a Friend?

As mentioned at the very beginning of this chapter, one of the biggest changes to the story of friendships has been the dilution of the term "friendship." In some ways, this dilution is a result of social networking sites like Friendster, Facebook, Snapchat, Instagram, etc. Today, we friend people on Facebook that we wouldn't have had any contact with 20 years ago. We have expanded the term "friend" to include everything from casual acquaintances to best friends. When we compare William Rawlins' six stages of friendships to how we use the term "friend" in the mediated context, we see that everything from friendly relations to stabilized friendships gets the same generic term, "friend."⁶⁹

One Australian writer, Mobinah Ahmad realized that the term "friend" was being widely used and often didn't fit the exact nature of the relationships she experienced. She created a six stage theory (see sidebar) to express how she views the nature of friendships in the time of Facebook. She started by analyzing her 538 "friends" on Facebook. The overwhelming majority of these friends really were acquaintances. In fact, of the 538 friends Ahmad had, she claimed that only one of them was a "true friend."⁷⁰

Now that you've had a minute to read through Mobinah Ahmad's six stage theory of friendships and

Friendship Acquaintance Six Stage Theory

Dear person reading this,

Find out where you fit in and the next time I tell you we aren't friends don't get offended. Now you'll know why. Love, Moby. P.S. This is not some exclusive thing, where I'm telling people they're unworthy. It's telling it like it is.

PreAcquaintance (10% of people I know)

- We don't know each other.
- We know each other's name only.

Acquaintance Level 1: To know of someone 20% of people I know

- We know of each other through mutual friends/acquaintances.
- We met briefly at a party/social event/university.
- You're a work colleague or business client (who I haven't spent much time with).
- We run into each other now and then by coincidence.
- Convenient Interactions Meeting up is not planned, and only because it is convenient and easy.
- Details about each other are superficial.

Acquaintance Level 2: Liking & Preliminary Care 30% of people I know.

- We went to school/university together, or have known you for a long period of time.
- We usually meet in groups, rarely one-on-one.
- If you needed my help, I would actively participate in helping them to the best of my ability.
- I can handle a 20-minute smalltalk chat with you, any longer and I will get bored.

Acquaintance Level 3: Significant Connection & Care 25% of people I know.

- We have a really good connection.
- We have some very meaningful talks.
- We care a lot about each other.
- We don't see each other all that much, just now and then when we plan to meet.

PreFriend (AKA Potential Friend) 14% of people I know

- Someone I wish were a friend (as defined below and NOT as society currently defines it)
- I want to spend more time with this person and establish a proper friendship with them.

Friend: Mutual Feelings of Love 1% of people I know

- I care immensely in every domain of their life (academic, physical, mental wellbeing), how their relationships with their loved ones are. I also care about their thoughts, ideas, elations, and fears.
- I can easily give my honest opinion and thoughts.
- This person notices when I am upset through subtle indications.
- I see this person regularly and feel totally comfortable to contact them for a deep and meaningful talk.
- Someone who takes initiative and makes sacrifices to work on this friendship.
- Mutual trust, respect, admiration, forgiveness and unconditional care. Note: If

it's not mutual, then we're not friends.

Further Notes

1. There is no shame in being an acquaintance. I think society has made the word derogatory and that is why it seems offensive. It's just about being honest.
2. Friendship is not that complicated to me (I know, the irony of making up a theory and calling it uncomplicated). There may be a small few that cannot be categorized because there is history and shades of grey but I look at my relationship with most people as being Black or White, categorized, uncomplicated.
3. The theory is flexible in the sense that people can go up or down the levels and understands that throughout a dynamic friendship, people become closer or further apart from each other.
4. My theory originates from personal experiences. I realize that one of my biggest vulnerabilities is that I'm too sentimental; this theory combats this problem quite efficiently.
5. I understand that this theory cannot be applied to everyone, but it significantly helps me.

Reprinted with Permission of the Author, Mobinah Ahmad.

acquaintances, how do you see this playing out in your own life? How many people whom you label as “friends” really are acquaintances?

Technologies and Friendships

Today a lot of our interaction with friends is mediated in some fashion. Whether it's through phone calls and texts or social media, gaming platforms, Skype, and other interactive technologies, we interact with our friends in new and unique ways. For example, in a study that came out in 2018, found that 60% of today's teenagers interact with their friends online daily while only 24% see their friends daily.⁷¹ Interacting online with people is fulfilling some of the basic functions that used to be filled through traditional face-to-face friendships for today's modern teenagers. Teens who spend time interacting with others in an online group or forum say that these interactions played a role in exposing them to new people (74%), making them feel more accepted (68%), figuring out important issues (65%), and helping them through tough times in life (55%).

But, are all technologies created equal when it comes to friendships? In a study by Dong Liu and Chia-chen Yang, the researchers set out to determine whether the way we perceive our friendships differs based on the communication technologies we use to interact.⁷² The researchers examined data gathered from 22 different research samples collected by researchers around the world. Ultimately, they found that there is a difference in how we use technologies to interact with friends. They labeled the two different categories Internet-independent (e.g., calls, texts) and Internet-dependent (e.g., instant messaging, social networking sites, gaming). Of the different technologies examined, “Mobile phone-based channels had stronger associations with friendship closeness, suggesting that phone calls and texting were predominantly used with closest associates.”⁷³ As a side note, the researchers did not find sex differences with regard to communication technologies use and friendship intimacy.

Research Spotlight

In 2018, Bree McEwan, Erin Sumner, Jennifer Eden, and Jennifer Fletcher set out to examine relational



maintenance strategies on Facebook among friends. Previous research by McEwan found that there were three different relational maintenance strategies used by members of Facebook:⁷⁴

1. Social Contact – personalizing messages to specific friends via Facebook.
2. Relational Assurances – demonstrating one’s commitment to continuing a relationship on Facebook.
3. Response Seeking – sending messages to a large number of people via Facebook in the hopes of getting input from an array of people.

In this study, the researchers found that social contact, relational assurances, and response seeking were all positively related to liking, relational closeness, relationship satisfaction, and relationship commitment.

McEwan, B., Sumner, E., Eden, J., & Fletcher, J. (2018). The effects of Facebook relational maintenance on friendship quality: An investigation of the Facebook Relational Maintenance Measure. *Communication Research Reports*, 35(1), 1-11. <https://doi.org/10.1080/08824096.2017.1361393>

Key Takeaways

- Although there was a historical perception that same-sex friendships were distinctly different, research has shown that there is more overlap between female-female and male-male friendships than there are actual differences.
- J. Donald O’Meara proposed five distinct challenges that opposite-sex relationships have: emotional bond (males and females are raised to see the opposite sex as potential romantic partners and not friends), sexuality (inherent in any opposite-sex friendship between heterosexual couples is sexual attraction), inequality and power (a fact of inequality and power-imbalance, created by our society, will always exist between people in opposite-sex); public relationships (opposite-sex friendships are often misunderstood and devalued in our society in favor of romantic relationships); and opportunity structure (our society often makes it difficult for opposite-sex friendships to develop).
- Cross-group friendships are an important part of our society. The two factors that have been shown to be the most important when developing opposite-sex friendships are time and self-disclosure. First, cross-group friendships take more time to develop as individuals navigate cultural differences in addition to navigating the terms of the friendship itself. Second, effective cross-group friendships are often dependent on the adequacy of self-disclosure. Individuals in cross-group friendships need to discuss not only the surface level issues in our lives, but they need to have deeper, more meaningful disclosures about who they are as individuals.

Exercises

- In your view, what is a postmodern friendship, and why is it an important

- perspective for communication scholars? Would any of your friendships fall within this framework? Why?
- Think of a time when you've had a cross-group friendship. What made it a cross-group friendship? How did this friendship differ from your same-group friendships? How was it similar to your same-group friendships? If you were explaining the importance of cross-group friendships in your life to another, what would you tell them?
 - Do you think the word "friend" has been devalued through the use of social media? When you look at Mobinah Ahmad's six stage theory of friendships, do you agree with her perspective? Why?

Chapter Wrap-Up

Friendships are a very important part of our interpersonal relationships. As such, we should never take our friendships for granted. For this reason, it's important to remember that friendships (like all relationships) take work. In this chapter, we started by exploring the nature and characteristics of friendships. We then examined the stages and types of friendships. We ended this chapter by exploring friendships in several different contexts.

End of Chapter

REAL WORLD CASE STUDY

Friendships often blossom between people that surprise those around them. For example, two U.S. Supreme Court Justices, Antonin Scalia and Ruth Bader Ginsburg, were known for having a decade's long friendship despite being on polar opposite ends of the political spectrum. They served on the Supreme Court for 22 years together until Scalia's death in 2016, but their actual friendship date back to the 1980s when they served on the federal circuit court in Washington, DC.

This unlikely friend pair was known to travel together with their spouses, and they shared an affinity for the opera. Scalia was Ginsburg's favorite souvenir shopping buddy when the two went on trips. There's even a famous picture of the two of them riding an elephant together during a trip to India.

So, how did the two handle their friendship when they were at such opposite ends of the political spectrum? Scalia once noted that if someone cannot agree to disagree with others and remain friends while on the bench, then they probably needed to get a different job.

1. Do you think these types of friendships are possible, given the deep political divides that are plaguing the United States?
 1. Why do you think Scalia and Ginsburg's friendship withstood the test of time and politics?
 2. How can you analyze this friendship using what you've learned in this chapter?

END OF CHAPTER QUIZ

1. Which of William K. Rawlins' friendship characteristics is the one marked by issues of emotional connection?
 - a. Affective
 - b. Equality
 - c. Mutual
 - d. Personal
 - e. Voluntary
2. Which stage of friendship development is marked by four specific communication behaviors: (1) moves away from what is required in the specific role relationship, (2) fewer stereotyped lines of interaction, (3) individual violations of public propriety, and (4) greater spontaneity?
 - a. Friendly Relations
 - b. Moves-Toward-Friendship
 - c. Nascent Friendship
 - d. Post-Friendship
 - e. Waning Friendship
3. Joan is one of those people who has a lot of friendships. She has friendships ranging from when she was a young kid and friendships she developed this year. She just has a tendency of making new friends and adding them to the list of friends she already has. Which of Sarah H. Matthews' friendship styles does Joan reflect?
 - a. Acquisitive
 - b. Affective
 - c. Communal
 - d. Discerning
 - e. Independent
4. _____ friendships are marked by activity.
 - a. Acquisitive
 - b. Affective
 - c. Agentic
 - d. Communal
 - e. Discerning
5. A _____ friendship is one where participants co-construct the individual and dyadic realities within specific friendships.
 - a. Affective
 - b. Agentic
 - c. Independent
 - d. Postmodern
 - e. Relational

References

- 1 Fehr, B. (1996). *Friendship processes*. Sage; pg. 5.
- 2 Hruschka, D. J. (2010). *Friendship: Development, ecology, and evolution of a relationship*. University of California Press.
- 3 Reisman, J. M. (1979). *Anatomy of friendship*. Irvington; pgs. 94-95
- 4 Friendship. (2018). *English Oxford living dictionaries*. Oxford University Press. Retrieved from: <https://en.oxforddictionaries.com/definition/friendship>
- 5 Denworth, L., & Waves, B. (2017, March 3). The three basics of friendship: Want to know who your real friends are? Look for these essential things. *Psychology Today*. Retrieved from: <https://www.psychologytoday.com/us/blog/brain-waves/201703/the-three-basics-friendship>
- 6 Seyfarth, R. M., & Cheney, D. L. (2012). The evolutionary origins of friendship. *Annual Review of Psychology*, 63, 153-177. <https://doi.org/10.1146/annurev-psych-120710-100337>
- 7 Lynch, S. (2015). Friendship and happiness from a philosophical perspective. In M. Demir (Ed.), *Friendship and happiness: Across the life-span and cultures* (pp. 3-18). Springer.
- 8 Clark v. Campbell, 82 N.H. 281 (N.H. 1926). Retrieved from: <https://casetext.com/case/clark-v-campbell-6>
- 9 Brown, B. B. (1981). A life-span approach to friendship: Age-related dimensions of an ageless relationship. *Research in the Interweave of Social Roles*, 2, 23-50; pg. 25.
- 10 Helmm, B. (2017, August 7). Friendship. *Stanford Encyclopedia of Philosophy*. Retrieved from: <https://plato.stanford.edu/entries/friendship/>
- 11 Wright, P. H. (1984). Self-referent motivation and the intrinsic quality of friendship. *Journal of Social and Personal Relationships*, 1(1), 115–130. <https://doi.org/10.1177/0265407584011007>
- 12 Monsour, M. (2017). The hackneyed notions of adult “same-sex” and “opposite-sex” friendships. In M. Hojjat & A Moyer (Eds.), *The psychology of friendship* (pp. 59-74). Oxford.
- 13 Rawlins, W. K. (1992). *Friendship matters: Communication, dialectics, and the life course*. Transaction.
- 14 Ibid.; pgs. 11-12.
- 15 Ibid.; pg. 12.
- 16 Affect. (2018). *APA dictionary of psychology*. American Psychological Association. Retrieved from <https://dictionary.apa.org/>
- 17 Wiemann, J. M. (1977). Explication and test of a model of communication competence. *Human Communication Research*, 3(3), 195-213. <https://doi.org/10.1111/j.1468-2958.1977.tb00518.x> pg. 195.
- 18 Rubin, K. H., & Rose-Krasnor, L. (1992). Interpersonal problem solving. In V. B. Hasselt & M. Hersen (Eds.), *Handbook of social development* (pp. 283-323). Plenum; pg. 285.
- 19 Arroyo, A., & Segrin, C. (2011). The relationship between self- and other-perceptions of communication competence and friendship quality. *Communication Studies*, 62(5), 547-562. <https://doi.org/10.1080/10510974.2011.580037>
- 20 McCroskey, J. C., & Richmond, V. P. (1976). The effects of communication apprehension on the perception of peers. *Western Speech Communication*, 40(1), 14-21. <https://doi.org/10.1080/10570317609373881>
- 21 McCroskey, J. C., & Sheahan, M. E. (1978). Communication apprehension, social preference, and social behavior in a college environment. *Communication Quarterly*, 26(2), 41-45. <https://doi.org/10.1080/01463377809369292>
- 22 Rubin, R. B., & Rubin, A. M. (1989). Communication apprehension and satisfaction in interpersonal relationships. *Communication Research Reports*, 6(1), 13-20. <https://doi.org/10.1080/08824098909359827>
- 23 Rawlins, W. K. (1989). Dialectical analysis of the tensions, functions and strategic challenges of communication in young adult friendships. *Communication Yearbook*, 12, 157–189.
- 24 Ibid.
- 25 Ibid.; pg. 171.
- 26 Laing, R. D. (1961). *Self and others*. Tavistock.

- 27 Ibid.
- 28 Mindful Staff. (2018, August). For the love of friends: Answers from our reader survey on friendship. *Mindful*, 6(3). 8-9; pg. 9.
- 29 Annameier, S. (2017, May 5). 3 simple ways to be more mindful in your friendships. <https://source.colostate.edu/3-simple-ways-mindful-friendships/>
- 30 Rawlins, W. K. (1981). *Friendship as a communicative achievement: A theory and an interpretive analysis of verbal reports* (Unpublished doctoral dissertation). Temple University, Philadelphia, PA.
- 31 Ibid.
- 32 Ibid.; pg. 46.
- 33 Rawlins, W. K. (1994). Being there and growing apart: Sustaining friendships during adulthood. In D. J. Canary & L. Stafford (Eds.), *Communication and relational maintenance* (pp. 275–294). Emerald.
- 34 LaBelle, S., & Myers, S. A. (2016). The use of relational maintenance behaviors in sustained adult friendships. *Communication Research Reports*, 33(4), 310-316. <https://doi.org/10.1080/08824096.2016.1224164>
- 35 Ibid.
- 36 Stafford, L. (2011). Measuring relationship maintenance behaviors: Critique and development of the Revised Relationship Maintenance Behavior Scale. *Journal of Social and Personal Relationships*, 28(2), 278–303. <https://doi.org/10.1177/0265407510378125>
- 37 Rawlins, W. K. (1981). *Friendship as a communicative achievement: A theory and an interpretive analysis of verbal reports* (Unpublished doctoral dissertation). Temple University, Philadelphia, PA; pgs. 57-58.
- 38 Johnson, A. J., Wittenberg, E., Haigh, M., Wigley, S., Becker, J., Brown, K., & Craig, E. (2004). The process of relationship development and deterioration: Turning points in friendships that have terminated. *Communication Quarterly*, 52(1), 54-67. <https://doi.org/10.1080/01463370409370178>
- 39 Matthews, S. H. (1986). *Friendships through the life course: Oral biographies in old age*. Sage.
- 40 Ibid.; pg. 34.
- 41 Ibid.; pg. 52.
- 42 Ibid.; pg. 53.
- 43 Wright, P. H. (2006). Toward an expanded orientation to the comparative study of women's and men's same-sex friendships. In K. Dindia & D. J. Canary (Eds.), *Sex differences and similarities in communication* (2nd ed., pp. 37-57). Lawrence-Erlbaum.
- 44 Phillips, G. M. & Wood, J. T. (1983). *Communication and human relationships: The study of interpersonal communication*. Macmillan.
- 45 Feingold, A. (1988). Matching for attractiveness in romantic partners and same-sex friends: A meta-analysis and theoretical critique. *Psychological Bulletin*, 104(2), 226-235.
- 46 Deaux, K. (1977). Sex differences. In T. Blass (Ed.), *Personality variables in social behavior* (pp. 357-377). Erlbaum.
- 47 Rawlins, W. K. (1993). Communication in cross-sex friendships. In A. Arliss & D. Borisoff (Eds.), *Women and men communicating: Challenges and changes* (pp. 51-70). Harcourt Brace Jovanovitch; pg. 51.
- 48 O'Meara, J. D. (1989). Cross-sex friendship: four basic challenges of an ignored relationship. *Sex Roles*, 21(7-8), 525–543. <https://doi.org/10.1007/BF00289102>
- 49 O'Meara, J. D. (1994). Cross-sex friendship's opportunity challenge: Uncharted terrain for exploration. *Personal Relationship Issues*, 2, 4-7.
- 50 Rawlins, W. K. (1982). Cross-sex friendship and the communicative management of sex-role expectations. *Communication Quarterly*, 30(4), 343–352. <https://doi.org/10.1080/01463378209369470>
- 51 Ibid.; pg. 344.
- 52 O'Meara, J. D. (1994). Cross-sex friendship's opportunity challenge: Uncharted terrain for exploration. *Personal Relationship Issues*, 2, 4-7.
- 53 Rawlins, W. K. (2009). *The compass of friendship: Narratives, identities, and dialogues*. Sage.
- 54 Werking K (1997b) Cross-sex friendship research as ideological practice. In Duck S (Ed.,) *Handbook of*

Personal Relationships (pp. 391-410). John Wiley & Sons.

55 Rumens, N. (2012). Queering cross-sex friendships: An analysis of gay and bisexual men's workplace friendships with heterosexual women. *Human Relations*, 65(8), 955-978. <https://doi.org/10.1177/0018726712442427>; pg. 960.

56 Monsour, M., & Rawlins, W. K. (2014). Transitional identities and postmodern cross-gender friendships: An exploratory investigation. *Women & Language*, 37(1), 11-39

57 Monsour, M. (2017). The hackneyed notions of adult "same-sex" and "opposite-sex" friendships. In M. Hojjat & A. Moyer (Eds.), *The psychology of friendship* (pp. 59-74). Oxford.

58 Ibid.; pg. 63.

59 Canary, D. J., & Hause, I. S. (1993). Is there any reason to research sex differences in communication? *Communication Quarterly*, 41(2), 129-141. <https://doi.org/10.1080/01463379309369874>

60 Monsour, M., & Rawlins, W. K. (2014). Transitional identities and postmodern cross-gender friendships: An exploratory investigation. *Women & Language*, 37(1), 11-39.

61 Ibid.; pg. 13.

62 Vela-McConnell, J. A. (2011). *Unlikely friends: Bridging ties and diverse friendship*. Lexington, pg. 8.

63 Ibid.; pg. 8.

64 Binder, J., Zagefka, H., Brown, R., Funke, F., Kessler, T., Mummendey, A., Maquil, A., Demoulin, S., & Leyens, J.-P. (2009). Does contact reduce prejudice or does prejudice reduce contact? A longitudinal test of the contact hypothesis among majority and minority groups in three European countries. *Journal of Personality and Social Psychology*, 96(4), 843-856. <https://doi.org/10.1037/a0013470>

65 Davies, K., Tropp, L. R., Aron, A., Pettigrew, T. F., & Wright, S. C. (2011). Cross-group friendships and intergroup attitudes: A meta-analytic review. *Personality and Social Psychology Review*, 15(4), 332-351. <https://doi.org/10.1177/1088868311411103>

66 Pew Internet & American Life Project. (2002). *The Internet goes to college: How students are living in the future with today's technology*. Retrieved from http://www.pewInternet.org/pdfs/PIP_College_Report.pdf

67 Gramlich, J. (2018, October 24). 8 facts about Americans and Facebook. *Pew Research Center*. Retrieved from: <http://www.pewresearch.org/fact-tank/2018/10/24/facts-about-americans-and-facebook/>

68 Ibid.

69 Rawlins, W. K. (1981). *Friendship as a communicative achievement: A theory and an interpretive analysis of verbal reports* (Unpublished doctoral dissertation). Temple University, Philadelphia, PA.

70 Low, N. (2015, October 28). Are your friends really your friends? Woman creates six-category test to establish who your real mates are - and you may be lonelier than you think! *Daily Mail.com*. Retrieved from: <https://www.dailymail.co.uk/news/article-3295180/Are-friends-really-friends-Woman-creates-six-category-test-establish-real-mates-lonelier-think.html>

71 Anderson, M., & Jiang, J. (2018, November 28). Teens social media habits and experiences 2: Teens, friendships and online groups. *Pew Research Center*. Retrieved from: <http://www.pewinternet.org/2018/11/28/teens-friendships-and-online-groups/>

72 Liu, D., & Yang, C. (2016). Media niche of electronic communication channels in friendship: A meta-analysis. *Journal of Computer-Mediated Communication*, 21(6), 451-466. <https://doi.org/10.1111/jcc4.12175>

73 Ibid.; pg. 459.

74 McEwan, B. (2013). Sharing, caring, and surveilling: An actor-partner interdependence model investigation of Facebook relational maintenance. *Cyberpsychology, Behavior, and Social Networking*, 16(12), 863-869. <https://doi.org/10.1089/cyber.2012.0717>

END OF CHAPTER QUIZ

ANSWER KEY

1) A 2) A 3) A 4) C 5) D





Image by [Brad Dorsey](#) from [Pixabay](#)

Chapter 11

Family & Marriage Relationships

Families are one of the essential relationships that all of us have in our lifetimes. Admittedly, there are a wide range of family types: adopted families, foster families, stepfamilies, nuclear families, and the families we make. According to the latest research from the [US Census Bureau](#), there are a wide range of different types of households in the United States today:

- Family households (83.48 Million)
- Married couple households (61.96 Million)
- Married couple households with own children (31.29 Million)
- Married couple households without own children (30.67 Million)
- Male householder, with own children (3.81 Million)
- Male householder, without own children (2.67 Million)
- Female householder, with own children (12.33 Million)
- Female householder, without own children (2.72 Million)

This chapter is going to explore the different types of family relationships and then end by looking at marriage.

11.1 Family Relationships

LEARNING OUTCOMES

1. Differentiate among various definitions of the word “family.”
2. Describe the term “family communication patterns” and the two basic types of family communication patterns.
3. Explain family systems theory and its utility for family communication researchers.

We interact within our families and begin learning our family communication pattern from the time we are born. Families are comparable to cultures in that each family has its own beliefs, customs, practices, rituals, and values. Interactions with other families reveal that there are vast differences between families. You may notice that the family down the street yells at each other almost constantly. Yelling is their baseline interaction, whereas another family never raises their voices and may seem to speak so infrequently that it appears that they have nothing to talk about within their family unit. These differences and our tendency as humans to make comparisons cause individuals to assess the value of the various styles of family communication.

Defining Family

One of the biggest challenges for family researchers has been to define the term “family.” The ambiguity of the term has often been seen in the academic literature. The definition of the family developed by Ernest W. Burgess was the first widely used definition by academics.¹ The term “family” was described as “two or more persons joined by ties of marriage, blood, or adoption; constituting a single household; interacting and communicating with each other in their respective social roles of husband and wife, mother and father, son and daughter, brother and sister; and creating and maintaining a common culture.”² According to Burgess, a family must be legally tied together, live together, interact together, and maintain a common culture together. The first three aspects of Burgess’ definition are pretty easy to conceptualize, but the concept of common culture deserves further explanation. Common culture consists of those communication interactions (day-to-day communication) and cultural tools (communication acts learned from one’s culture previous to the marriage) that each person brings into the marriage or family. The various tools and interactions form a unique and individual subculture that exists within the context of the new family. A couple can pick and choose from their various backgrounds which communicative acts are most important to them and integrate those into the family unit. If a couple has communicative acts that are polarized, then a couple will need to negotiate and form new ways of communicating. Burgess’ definition of the family was useful because he was the first to examine the family structure’s attempt to maintain a common culture, but it also has many serious problems that cannot be ignored. Burgess’ definition of the word “family” excludes single parent families, commuter families, bisexual, gay, lesbian, and transgendered/transsexual families, and families who do not choose to, or are unable to, have children.

Statistical Definition of 'Family' Unchanged

By David Pemberton (2015, January 28)

What is the Census Bureau's definition of "family"?

Printed decennial census reports from 1930 to the present are consistent in their definition of "family." The 2010 version states: "A family consists of a householder and one or more other people living in the same household who are related to the householder by birth, marriage or adoption."

The 1930 version is strikingly similar: "Persons related in any way to the head of the family by blood, marriage or adoption are counted as members of the family."

But prior to 1930, the definition of a family was quite different.

The 1920 version went like this: "The term 'family' as here used signifies a group of persons, whether related by blood or not, who live together as one household, usually sharing the same table. One person living alone is counted as a family, and, on the other hand, the occupants or inmates of a hotel or institution, however numerous, are treated as a single family."

The 1900 Census announced: "The word family has a much wider application, as used for census purposes, than it has in ordinary speech. As a census term, it may stand for a group of individuals who occupy jointly a dwelling place or part of a dwelling place or for an individual living alone in any place of abode. All the occupants and employees of a hotel, if they regularly sleep there, make up a single family, because they occupy one dwelling place ..."

The older definition is closer to the current use of the term "household."

Enumerator instructions beginning in at least 1860 and extending at least through 1940 emphasize this older definition of family.

Here is an example from the 1860 instructions: "By the term 'family' is meant either one person living separately and alone in a house, or a part of a house, and providing for him or herself, or several persons living together in a house, or part of a house, upon one common means of support and separately from others in similar circumstances. A widow living alone and separately providing for herself, or 200 individuals living together and provided for by a common head, should each be numbered as one family."

The 1870 instructions add the element of eating together as one defining element of a family: "Under whatever circumstances, and in whatever numbers, people live together under one roof, and are provided for at a common table, there is a family in the meaning of the law."

By 1930, the concept of a "household" had become more important and by implication was separated from the term "family": "A household for census purposes is a family or any other group of persons, whether or not related by blood or marriage, living together with common housekeeping arrangements in the same living quarters."

In 1960, the concepts of household and family were even more clearly delineated: "A household

consists of a group of people who sleep in the same dwelling unit and usually have common arrangements for the preparation and consumption of food. Most households consist of a related family group. In some cases, you may find three generations represented in one household. Some household members may have no family relationship to the central group — boarders and servants, for example — but they should be included with the household if they eat and sleep in the same dwelling unit.”

In summary, the definition of family before 1930 was more similar to today’s definition of household. However, since 1930, the definition of family has remained the same, and includes those who are related to the householder by birth, marriage, or adoption.

<https://www.census.gov/newsroom/blogs/random-samplings/2015/01/statistical-definition-of-family-unchanged-since-1930.html>

After examining the flaws of Burgess’ definition of the word “family,” an anthropologist, George Peter Murdock, attempted to define the family, “Social group characterized by common residence, economic cooperation, and reproduction. It includes adults of both sexes, at least two of whom maintain a socially approved sexual relationship, and one or more children, own or adopted, of the sexually cohabiting adults.”³ Once again, this definition only allows for heterosexual couples who have children to be considered a family because of the “socially approved” sexual relationship clause.

Another problem with this definition deals with the required inclusion of children for a couple to be labeled as a family. Many couples are unable to have children. Yet other couples opt not to have children. Does this really mean that they are not families? Couples, with or without children, should be considered as family units. All in all, this definition gave more direction than the Burgess one, but it is still extremely ambiguous and exclusive.

Another anthropologist, Bronislaw Malinowski, was looking at tribal familial structures all over the world at the turn of the century and defined the family as having 1) boundaries, 2) common residence, and 3) mutual affection for one another.⁴ Malinowski’s definition deals primarily with the fact that in different cultures around the world, a family member may include anyone from the immediate family of origin who gave birth to a person, to any member of the society into which one is born. Many African tribes see the tribe as being the family unit, and the tribe takes it upon itself to raise the children.

The United States’ societal concept of the term “family” became very rigid during the 1950s when the family was depicted by social norms and the media as a mother, father, 2.5 offspring, and the family dog living together behind a white picket fence in the suburbs.⁵ Though this is currently what many Americans picture as the typical 1950s’ family, the reality was considerably different. According to Steven Mintz and Susan Kellog the family structure was very weak in the 1950s.⁶ Women started using tranquilizers as a method for dealing with normal household duties, and the divorce rate skyrocketed when compared with the 1940s. Currently, only around seven percent of U.S. families participate in the so-called “traditional” 1950s-style family with Ozzie, the breadwinning father, and Harriet, the happy homemaking mother, enjoying their first marriage, which has produced two or more school-aged children.⁷

During the 1970s, a variety of psychologists attempted to define the term “family.” Arthur P. Bochner defined the family as “an organized, naturally occurring relational interaction system, usually occupying a common living space over an extended time, and possessing a confluence of interpersonal images which evolve through the exchange of messages over time.”^{8,9} Though this definition is broad enough to allow for a variety of relationships to be considered families, the definition is too vague. It has allowed

almost anything to be considered a family. Take, for example, individuals who live in a dormitory setting either at a college or in the military. The first part of Bochner's definition of family is that it has an organized, naturally occurring relational interaction system. In essence, this means that any group that has organization and interacts through various relationships accomplishes part of what it means to be a family. People who live in dormitories interact through various relationships on a regular basis. Whether it be relating with one's roommate or with the other people who live in the rooms next to you, people in dorms do interact. Dormitories are generally highly organized. People are required to listen to complex directors and Resident Assistants (on a collegiate level). Also, with the myriad of dormitory softball teams and other activities, interaction occurs regularly.

The second part of Bochner's definition of the family deals with occupying a common living space for an extended period. People who live in college dormitories do so for around a year. To many transient people, this can be seen as an extended period. The extended time clause is very awkward simply because of its ambiguity.

The last aspect of Bochner's definition of the family deals with the possession of interpersonal images that evolve through communication. Many people who live in the same space will start to acquire many stories and anecdotes concerning those people with whom they are in close proximity. Whether it be remembering the night that a group went on a beer run or the time when everyone pulled together to win the intramural softball competition, a variety of interpersonal images will be created through communication.

As can be seen through the previous discussion, dormitories are facilities where people cohabitate with others for extended amounts of time and share interpersonal images that change over time. The people who live in dorms under this definition could be considered as a family unit. These groups of people should not be considered as a family unit because dorm residents lack the permanence that is needed within a family structure. Once an academic year is over, the people go their directions, and many people will never see or talk to those people with whom they once lived. A family has an ongoing relationship that is constantly functioning even when the individuals are forced to live apart from the family of origin. Once again, here is a definition that does not allow for a concise explanation that can be easily applied when analyzing a family unit.

To understand the concept of a family, the definitions should be combined in such a way that all types of family structures (e.g., single parent, LGBTQIA+, non-married parents) are included. For our purposes a **family** is defined as two or more people tied by marriage, blood, adoption, or choice; living together or apart by choice or circumstance; having interaction within family roles; creating and maintaining a common culture; being characterized by economic cooperation; deciding to have or not to have children, either own or adopted; having boundaries; and claiming mutual affection. This does not necessarily say that all types of families are healthy or legal, but that all cohabiting groups that consider themselves to be families should be researched as such to understand the specific interactions within the group. Though one may disagree with a specific family group, understanding the group through a family filter can lend itself to a better understanding than could be reached by analyzing the group through an organizational filter. To understand this definition of family, an analysis of the various aspects of this study's definition shall be done to help clarify this definition.

Marriage, Blood, Adoption, or Choice

The first part of the definition says that a family is "two or more people tied by marriage, blood, adoption, or choice." This part of the definition allows for a variety of family options that would not be accepted otherwise. This definition also allows for children who become part of a foster family to

have a family that they can consider their own, even if they are switched from family to family. Non-married couples who consider themselves a family should also be researched as such. This aspect of the definition does open itself to some family types that are seen as illegal (e.g., family members marrying each other). This definition does not attempt to create a legal definition of family as much as it attempts to create a definition under which the family can be studied. As mentioned earlier, not all forms of family are necessarily healthy or legal. This part of the definition broadens the field of family study while the remaining criteria narrows the focus so that not just any group can call itself a family.

Cohabitation

The second part of the definition of family indicates that the cohabitants may live together or apart by choice or circumstance. There are a variety of married couples who are not able to live in the same place because of occupation. According to Naomi Gerstel and Harriet Engel Goss, a commuter family is such a family:

The existence of marriages in which spouses separate in the service of divergent career demands at least suggests a need to question both the presupposition that coresidence is necessary for marital viability and its corollary that husbands and wives necessarily share economic fates. Dubbed “commuter,” “long-distance” or “two location” families, these marriages entail the maintenance of two separate residences by spouses who are apart from one another for periods ranging from several days per week to months at a time.¹⁰

These marriages, seen as nontraditional by many, are becoming an increasingly common occurrence within the United States. Any member of the military who is stationed in the United States and sent to other parts of the world without their family experiences the problems caused by commuter marriages. Just because these families are not able to live under the same roof does not mean that they are not a family.

Family Roles

The third criterion of the definition of “family” suggests that the persons interact within family roles. These roles include such terms as mom, dad, son, daughter, wife, husband, spouse, and offspring. When an adult decides to be the guardian either by birth, adoption, or choice, the adult has taken on the role of a father or mother. When a group takes on the roles of parental figures and child figures, they have created a family system within which they can operate. Some of these roles can be related to the understanding of extended family as well, such as grandmother, aunt, uncle, niece, nephew, and the like. These roles and the rules that cultures associate with them have a definite impact on how a family will function.

Common Culture

The fourth aspect, creating a common culture, stems directly from Burgess’ definition.¹¹ Couples bring other aspects (communicative acts, history, cultural differences, etc.) of their lives into the family to create the new subculture that exists in the new family. This can be done whether you have two men, a mother and daughter, or a husband and wife. When a couple joins to create a family unit, they are bringing both of their cultural backgrounds to the union, thus creating a unique third family culture that combines the two initial family cultures.

Economic Cooperation

The fifth trait of a family deals with economic cooperation, or the general pooling of family resources for the benefit of the entire family. Economic cooperation is typically thought of in the context of nuclear families, but in commuter families both units typically pool their resources in order to keep both living establishments operational. Even though the family is unable to live together, the funds from both parties are used for the proper upkeep and maintenance of each location. In many instances, overseas military men and women will send their paychecks to their families back in the States because they will not need the money while they are out at sea or abroad, and their families still have bills that must get paid. Economic cooperation allows families who have dual earners to establish a more egalitarian relationship between the spouses since no one person is seen as the worker and the other as the non-worker.

Children

The sixth component of the definition of a family deals with children as a part of a family. Many researchers (Burgess, 1926; Murdock, 1949; Bailey, 1988) have said that for a family to exist, it must have offspring.¹² This would mean that a couple who is infertile and only wants to raise children if they are biologically related would not be considered a family. This also prevents couples who do not desire to have children from achieving a family status. There are many unions of people who are not able to have children or do not desire to have children who are clearly families.

Established Boundaries

The seventh characteristic of a family deals with the need for the family to establish boundaries. Family boundaries is a concept that stems from family systems theory. According to Janet Beavin Bavelas and Lynn Segal, boundaries are those aspects of a family that prevent the family from venturing beyond the family unit.¹³ Boundaries function as a means for a family to determine the size and the scope of family interactions with the greater system or society. The family can let information into the family or exclude it from the family.

An example of this can be seen in religious parents/guardians who are coming to terms with the fact that their son is gay. These parents/guardians often reject information from the family system that would indicate that homosexuality is natural. In this example, the parents/guardians draw an informational boundary and refuse to let information that could contradict their position into the family system. Also, families do not function entirely in conjunction with the system of which they are a part. Families must filter information or risk information overload. Families have naturally occurring and created boundaries that decide how a family should and should not operate. Many families create boundaries that deal with religious discussion, or they do not allow for any rejection of the family's religious beliefs on any level. This is an example of a boundary that a family can create. Conversely, there are boundaries that a family must respect because of societal laws. Understanding these boundaries is necessary because it allows the researcher a greater understanding of the context in which the family lives.

Love and Trust

The eighth, and final, trait of a family, mutual affection, deals with the concept of love and trust that a family tends to possess to help them journey through conflict situations. Mutual affection also means that an individual must have a desire to be within the family or possess the freedom to leave the family system when they are of age. Families are not coercive entities but entities in which all participants can freely make personal decisions to belong. Leaving the family system does not guarantee that a member of a

family will be able to lose all connections to the family itself. Besides, the family will have had an impact on members that will affect them even if they leave the family of origin and cut all ties.

Understanding the definitions presented about the family and their obvious limitations will help in understanding of the usefulness of this new definition. Too often, definitions of the word “family” have been so narrow in scope that only some families were studied, and thus the research into the family came from only a very narrow and rigid perspective. Defining what constitutes a family is a difficult task, but without a clear definition, the study of family communication cannot be done effectively.

Family Communication Patterns

Two communication researchers, Jack M. McLeod and Steven H. Chaffee, found that most models of families relied on dichotomous ideas (e.g., autocratic/democratic, controlling/permissive, modern/traditional).¹⁴ Instead of relying on these perspectives, McLeod and Chaffee realized that family communication happens along two different continuums: socio-orientation and concept-orientation. In a series of further studies, David Ritchie and Mary Anne Fitzpatrick identified two family communication patterns: conformity orientation and conversation orientation.^{15, 16}

Socio-Orientation

To McLeod and Chaffee, **socio-oriented** (conformity oriented) families are indicated by “the frequency of (or emphasis on) communication that is designed to produce deference, and to foster harmony and pleasant social relationships in the family.”¹⁷ Families high in socio-orientation tend to communicate a similarity of attitudes, beliefs, and values. Similarity and harmony are valued while conflicts are avoided. Family members maintain interdependence within a hierarchical structure. One of the authors comes from a family where similarity and harmony were valued to the extent that any amount of disagreement was frowned upon. The parents never (literally) argued or disagreed in front of the children. Despite the desires of her parents, the personalities of the children soon emerged and revealed that neither child could go along with total similarity and harmony. One child dealt with this difference by learning to keep his opinions to himself. The other sibling, who happened to be the oldest child, never learned to keep her opinion to herself. Her communication style simply did not align with the conformity orientation and friction was the result. You may have similar experiences if your communication style is different from your family’s communication orientation.

Concept-Orientation

To McLeod and Chaffee, **concept-oriented** (conversation oriented) families use “positive constraints to stimulate the child to develop his own views about the world, and to consider more than one side of an issue.”¹⁸ High concept-orientation families engage in open and frequent communication. Family life and interactions are perceived to be pleasurable. Self-expression is encouraged when attempting to make family decisions. Parents/guardians and children communicate in such a way that parents/guardians socialize and educate their children. Understanding the communication pattern within a family can lead to the ability to adapt to the family communication pattern rather than consistently communicating in a manner that is uncomfortable within the family structure.

Four Combinations

To further explain the concepts of socio- and concept-orientations, Jack M. McLeod and Steven H. Chaffee broke the combinations into four specific categories (Figure 11.2).

Consensual

The first family communication pattern is the consensual family, which is marked by both high levels of socio- and concept-orientation. The term “consensual” is used here because there is a tendency in these families to strive for or have pressure for agreement between parents/guardian and children. Children are encouraged to think outside the box as long as it doesn’t impact the parents/guardians’ power or the family hierarchy. However, “These conflicting pressures may induce the child to retreat from the parent/guardian-child interaction. There is some evidence of ‘escape’ by consensual children, such as strikingly heavy viewing of television fantasy programs.”¹⁹

Protective

The second type of family communication pattern is the protective family, which is marked by high levels of socio-orientation and low levels of concept-orientation. In these families, there tends to be a strong emphasis on child obedience and family harmony. As such, children are taught that they should not disagree with their parents/guardians openly or engage in conversations where differences of opinion may be found. McLeod and Chaffee noted that parents/guardians strive to protect their children from any kind of controversy, which may actually make them more vulnerable to outside pressures and persuasion because they have not been taught how to be critical thinkers.

Pluralistic

The third type of family communication pattern is pluralistic, which is the opposite of the protective family and marked by high levels of concept-orientation and low levels of socio-orientation. In these families, “The emphasis in this communication structure seems to be on mutuality of respect and

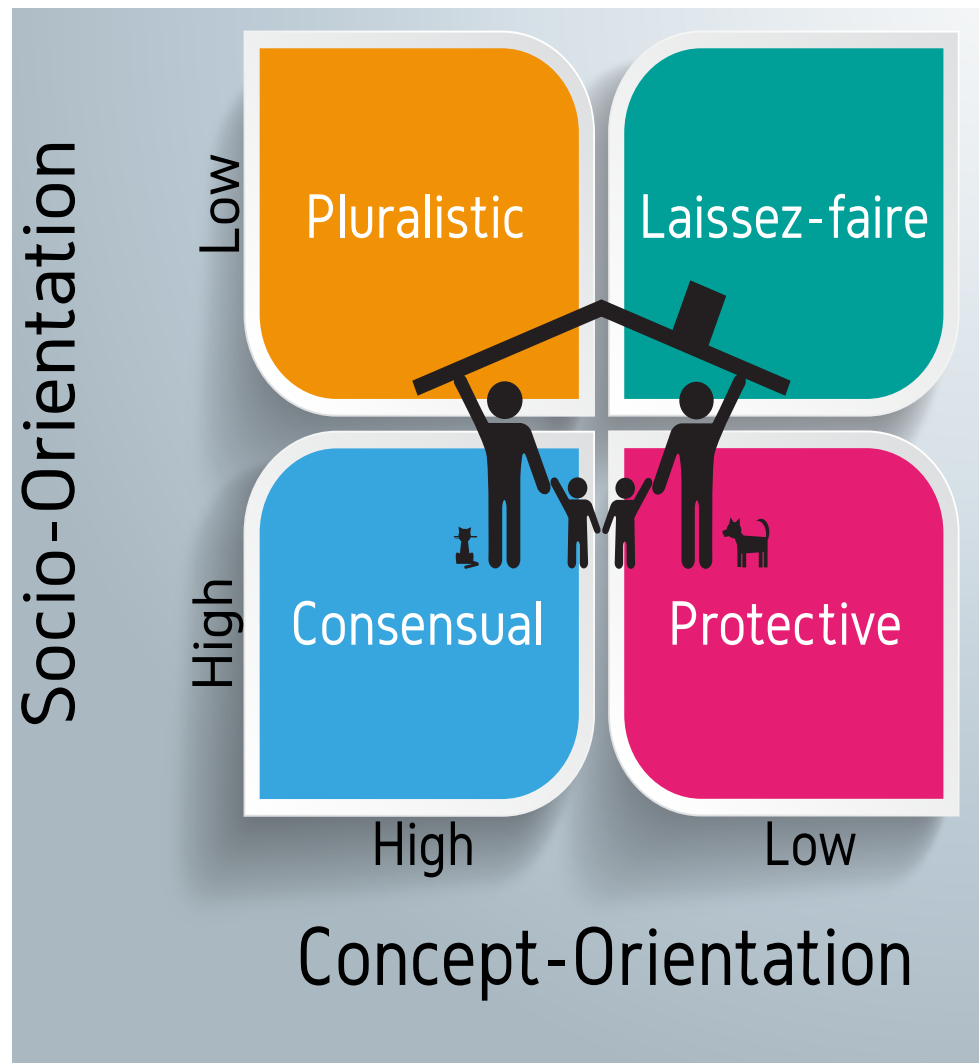

Figure 11.2. Family Communication Pattern

interests: the combination of an absence of social constraint plus a positive impetus to self-expression should foster both communication and competence.”²⁰ Some parents/guardians worry that this type of openness of thought actually creates problems in their children, but McLeod and Chaffee noted that these families have children who are more likely to say they want to grow up and be like their parents/guardians than the other three types.

Laissez-faire

The final family communication pattern, laissez-faire, is marked by both low concept- and socio-orientations. In these families, there tends to be a lack of parent-child interaction or co-orientation. Instead, these children are more likely to be influenced by external factors like the media, peers, and other forces outside of the family unit. McLeod and Chaffee said that these children are more like a control group in an experiment because of the hands-off nature of their communicative relationships with their patterns. As such, it’s somewhat difficult to discuss the effectiveness of this study of family communication.

Research Spotlight



In a 2018 study by Kelly G. Odenweller & Tina M. Harris, the researchers set out to examine the relationship between family communication patterns and adult children’s racial prejudice and tolerance. The researchers used a mostly college-aged sample of 190 adults.

Parental use of socio-oriented family communication patterns was positively related to an adult child’s reported levels of prejudice and bias towards their own group, and negatively related to being racially tolerant. As for concept-orientation, there were no relationships found at all.

Ultimately, a parent’s conformity oriented family communication style can affect their children’s racial biases.

Odenweller, K. G., & Harris, T. M. (2018). Intergroup socialization: The influence of parents’ family communication patterns on adult children’s racial prejudice and tolerance. *Communication Quarterly*, 66(5), 501–521. <https://doi.org/10.1080/01463373.2018.1452766>

Family Systems Theory

At the turn of the 20th Century, philosophers started questioning how humans organize things and our understanding of organizing. One critical theorist was Belarusian-born Alexander Aleksandrovich Bogdanov, who wrote a philosophical treatise on the nature of organization in 1922.²¹ Bogdanov’s ideas ultimately influenced Ludwig von Bertalanffy’s general systems theory. In a series of works, Bertalanffy conceptualized what has become known as general systems theory.²² Bertalanffy defined a **system** as “sets of elements standing in interrelation.”²³ A classic mechanical system is a non-digital watch. Figure 11.3 shows the basic layout of a watch’s innards.

In this illustration, we see how the balance wheel causes the fork pin to move, which turns the escapement wheel. The escapement wheel turns the third wheel (seconds), which turns the second wheel, which

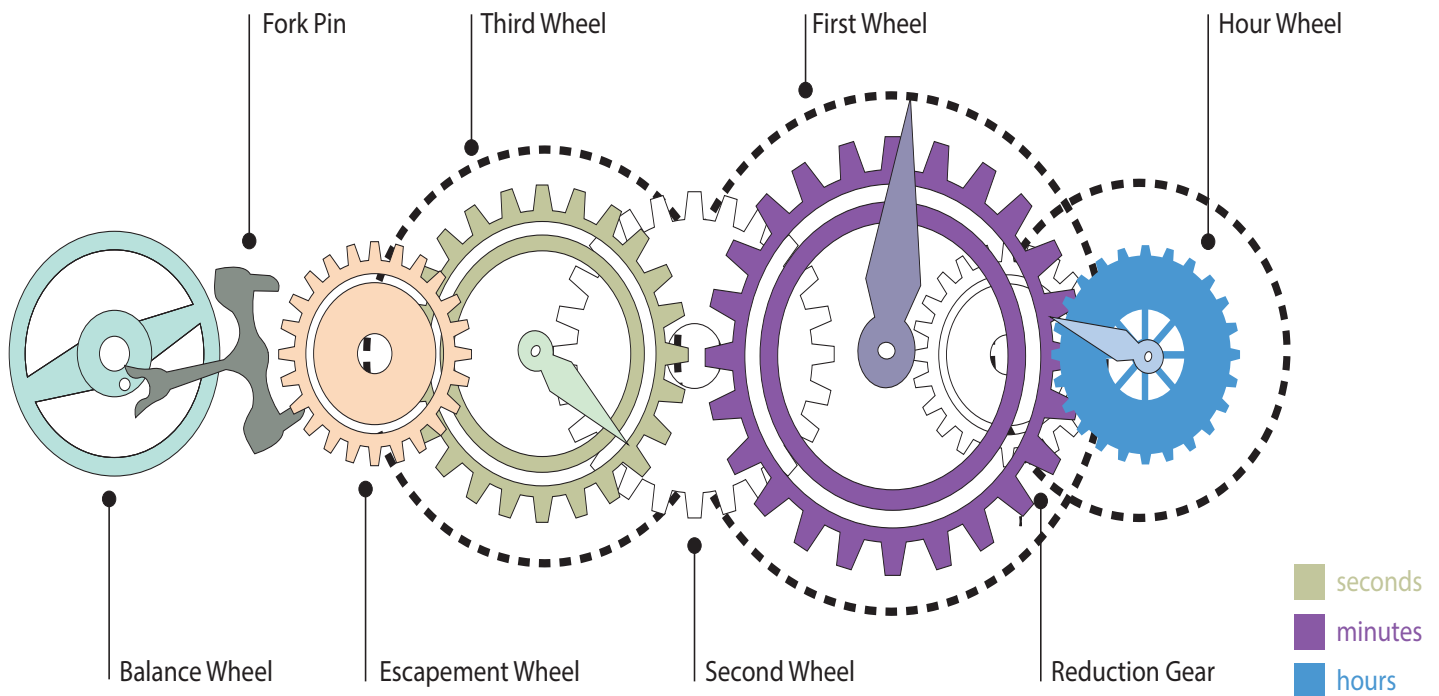

Figure 11.3. Watch System

turns the first wheel (minutes), which turns the reduction gear, which turns the hour wheel. All of these different parts must work together to tell time. If a problem arises at any part of this process, then it will effect the entire system and our ability to tell time accurately.

So, how does this ultimately help us understand family communication? A psychiatrist named Murray Bowen developed family systems theory in the 1950s while working at the National Institute of Mental Health. His theory stemmed from the work of general systems theory discussed by Bertalanffy.²⁴ Like Bertalanffy, Bowen's theory started by examining how everything exists within nature and is governed by natural processes. Two of these processes, individuality and togetherness, became central to these ideas.²⁵ **Individuality** is a "universal, biological life force that propels organisms toward separateness, uniqueness, and distinctiveness."²⁶ **Togetherness**, on the other hand, is "the complementary, universal, biological life force that propels organisms toward relationship, attachment, and connectedness."²⁷ This essential dialectical tension creates an organism's differentiation, or its drive to be both individualistic while maintaining intimate connections with others in the larger environment. This more ecological view of how humans exist becomes a central tenant of Bowen's family systems theory. Bowen argues that human behavior was not greatly determined by social-construction or intra-psychically generated. Instead, Bowen believes that a great deal of human behavior is habitual and rooted in billions of years of evolutionary history.

In his earliest work, Bowen examined schizophrenic patients as he was interested in the development and treatment of schizophrenia. Instead of focusing just on the schizophrenic patient, Bowen started analyzing the broader range of relationships within the individual family units. Ultimately, Bowen argued that schizophrenia might be an individual diagnosis, but is in reality, "a symptom manifestation of an active process that involves the entire family."²⁸ Dr. Bowen goes on to rationalize, "When schizophrenia is seen as a family problem, it is not a disease in terms of our usual way of thinking about disease...When the family is viewed as a unit, certain clinical patterns come into focus that are not easily seen from the more familiar individual frame of reference."²⁹ In essence, when we stop to think about a family as a system, it's much easier to understand the manifestations of behaviors of family members.

Characteristics of Family Systems

Over the years, numerous researchers have furthered the basic ideas of Murray Bowen to further our understanding of family systems. Part of this process has been identifying different characteristics of family systems. According to Kathleen Galvin, Fran Dickson, and Sherilyn Marrow,³⁰ there are seven essential characteristics of family systems: interdependence, wholeness, patterns/regularities, interactive complexity, openness, complex relationships, and equifinality.

Interdependence

The term interdependence means that changes in one part of the system will have ramifications for other parts of the system. For example, if one of the gears in your watch gets bent, the gear will affect the rest of the watch's ability to tell time. In this idea, the behaviors of one family member will impact the behaviors of other family members. To combine this idea with family communication patterns described earlier, parents/guardians that are high in socio-orientation and low in concept-orientation will impact those children's willingness and openness to communicate about issues of disagreement.

On the larger issue of pathology, numerous diseases and addictions can impact how people behave and interact. If you have a family who has a child diagnosed with cancer, the focus of the entire family may shift to the care of that one child. If the parents/guardians rally the family in support, this diagnosis could bring everyone together. On the other hand, it's also possible that the complete focus of the parents/guardians turns to the ill child and the other children could feel unattended to or unloved, which could lead to feelings of isolation, jealousy, and resentment.

Wholeness

The idea of wholeness or holism is to be able to see behaviors and outcomes within the context of the system. To understand how a watch tells time, you cannot just look at the fork pin's activity and understand the concept of time. In the same way, examining a single fight between two siblings cannot completely let you know everything you need to know about how that family interacts or how that fight came to happen. How siblings interact with one another can be manifestations of how they have observed their parents/guardians handle conflict among themselves or even extended family members like aunts/uncles, grandparents, and cousins.

Holism is often discussed in opposite to reductionism. Reductionists believe that the best way to understand someone's communicative behavior is to break it down into the simplest parts that make up the system. For example, if a teenager exhibits verbal aggression, a reductionist would explain the verbally aggressive behavior in terms of hormones (specifically testosterone and serotonin). Holistic systems thinkers don't negate the different parts of the system, but rather like to take a larger view of everything that led to the verbally aggressive behavior. For example, does the teenager mirror their family's verbally aggressive tendencies? Basically, what other parts of the system are at play when examining a single behavioral outcome.

Patterns/Regularities

Families, like any natural organism, like balance and predictability. To help with this balance and predictability, systems (including family systems) create a complex series of both rules and norms. Rules are dictates that are spelled out. Many children grow up hearing, "children are to be seen and not heard." This rule dictates that in social situations, children are not supposed to make noise or actively

communicate with others. Norms, on the other hand, are patterns of behavior that are arrived at through the system. For example, maybe your mother has a home office, and everyone knows that when she is in her office, she should not be disturbed.

Of course, one of the problems with patterns and regularities is that they become deeply entrenched and are not able to be changed or corrected quickly or easily. When a family is suddenly faced with a crisis event, these patterns and regularities may prevent the family from actively correcting the course. For example, imagine you live in a family where everyone is taught not to talk about the family's problems with anyone outside the family. If one of the family members starts having problems, the family may try to circle the wagons and ultimately not get the help it needs. This is an example of a situation that happened to one of our coauthors' families. In this case, one of our coauthor's cousins became an alcoholic during his teen years. We'll call him Jesse. Very few people in the immediate family even know about Jesse's problems. Jesse's mother was a widely known community leader, so there was a family rule that said, "don't make mom or our family look bad." When Jesse's parents found out about his alcoholism (through a DUI), they circled the wagons and tried to deal with the problem as a family. Unfortunately, dealing with a disease like alcoholism by closing ranks is not the best way to get someone treatment. One night Jesse's mother was called out to an accident at a local night club where a drunk driver had hit several people. When Jesse's mother showed up, it was only then that she learned that the drunk driver had been her son.

In this case, the rule about protecting the family's image had become so ingrained, that the family hadn't taken all of the steps necessary to get Jesse the help he needed. Although no one died in the accident, one young woman hit by Jesse was paralyzed for the rest of her life. Jesse ended up going to prison for several years.

Interactive Complexity

The notion of interactive complexity stems back to the original work conducted by Murray Bowen on family systems theory. In his initial research looking at schizophrenics, a lot of families labeled the schizophrenic as "the problem" or "the patient," which allowed them to put the blame for family problems and interactions on the schizophrenic. Instead, Bowen realized that schizophrenia was one person's diagnosis in a family system where there were usually multiple issues going on. Trying to reduce everything down to the one label, essentially letting everyone else "off the hook" for any blame for family problems, was not an accurate portrayal of the family.

Instead, it's important to think about interactions as complex and stemming from the system itself. For example, all married couples will have disagreements. Some married couples take these disagreements, and they become highly contentious fights. These fights are often repetitious and seen over and over again. Mary asks Anne to take out the trash. The next day Mary sees that the trash hasn't been taken out yet. Mary turns to Anne at breakfast and says, "Are you ever going to take out the trash?" Anne quickly replies, "Stop nagging me already. I'll get it done when I get it done." Before too long, this becomes a fight about Anne not listening to Mary from Mary's point-of-view, while the conversation becomes about Mary's constant nagging from Anne's point-of-view. Before long, the argument devolves into an argument about who started the conflict in the first place. Galvin, Dickson, and Marrow argue that trying to determine who started the conflict is not appropriate from a systems perspective, instead, researchers should focus on "current patterns serve to uncover ongoing complex issues."³¹

Openness

The next major characteristic of systems is openness. The term openness refers to how permissive system boundaries are to their external environment. Some families have fairly open boundaries. In essence, these families allow for a constant inflow of information from the external environment and outflow of information to the external environment. Other families are considerably more rigid about system boundaries. For example, maybe a family is deeply religious and does not allow television in the home. Furthermore, this family only allows reading materials that come from their religious sect and actively prevents any ideas that may threaten their religious ideology. In this case, the family has a very rigid and closed boundary. When families close themselves off from the external environment, they essentially isolate themselves. Children who are reared in highly isolated family systems often have problems interacting with other children when they come into contact with them in the external environment (e.g., school). Some families will choose to homeschool their children as another tool to close the family system to foreign ideas and influences.

Complex Relationships

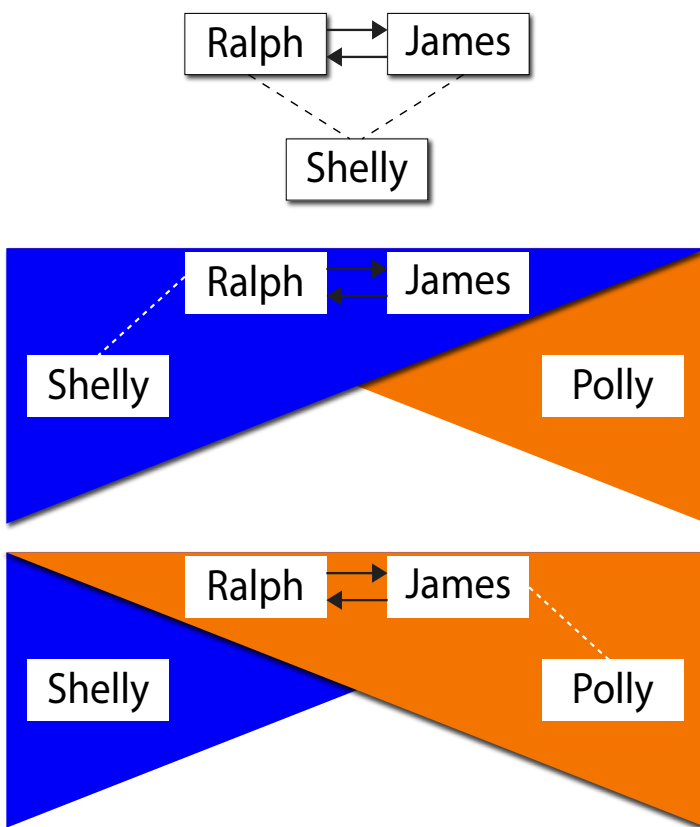

Figure 11.4. Nature of Three

It's important to remember that all family systems also have multiple subsystems. One of the areas that Murray Bowen became very interested in was how family subsystems develop and function during times of crisis. In Bowen's view, a couple may be the basic unit within an emotional relationship. Still, any tension between the couple will usually result in one or both parties turning to others. If there are not others within the family itself, partners will bring external people into the instability. For example, James and Ralph just got married. After a recent argument, Ralph ended up talking to his best friend, Shelly, about the argument (Figure 11.4). Bowen argues a two-person system under stress will draw in a third party to provide balance, which ultimately creates a two-helping-one or a two-against-one dynamic. It's also possible that James decides to talk to his mother, Polly, which creates a different triangle.

Families are filled with relationship triangles. We could describe Ralph and James as parents and Shell and Polly as their daughters just as easily.

These triangles are always being created and defined within a family unit when there is instability between two people. During times of crisis, these triangles take on a solution to the instability in the two-person relationship. Unfortunately, this "solution" is either two-helping-one or a two-against-one.³² Basically, in a triangle, there are now two people on one side and one on the other, so it gives a sense of balance. The more family members we start to include, the more complicated these triangle structures become.

Equifinality

The final characteristic of family systems is equifinality. Equifinality is defined as the ability to get to the

same end result using multiple starting points and paths. Going back to the basic definition of “family” discussed earlier in this chapter, there are many different ways for people to form relationships that are called families. Within family systems theory, the goal is to see how different family systems achieve the same outcomes (whether positive or negative).

MINDFULNESS ACTIVITY



Research has demonstrated that parental mindfulness has an indirect impact on children’s internalizing or externalizing of problems.³³ As such, mindful parenting is an extremely useful tool when raising children (specifically being attentive, non-judgmental, and non-reactive). Furthermore, Jill Suttie recommends three specific factors for successful mindful parenting:

1. Noticing your own feelings when you’re in conflict with your child,
2. Learning to pause before responding in anger,
3. Listening carefully to a child’s viewpoint even when disagreeing with it.³⁴

Myla and Jon Kabat-Zinn define mindful parenting as “Seeing if we can *remember* to bring this kind of attention and openness and wisdom to our moments with our children. It is a true *practice*, its own inner discipline, its own form of meditation.”³⁵ The essence of mindful parenting is about being present in one’s day-to-day interactions with their children. For this activity, answer the following questions. If you are not a parent, think about how your own parents and/or guardians would answer these questions.

1. When you are spending time as a family, are you free from distractions (e.g., cell phones, television)?
2. Does your family have a clear schedule that creates a stable routine (e.g., family mealtimes, bedtimes for children)?
3. Does your family engage in “family time” that does not involve technology?
4. How often do you dedicate time to focus purely on your child’s needs?
5. When engaging in a conflict with your child, do you remove yourself when you start to get angry (taking a “time out”)?
6. How often do you apologize to your child when you’re wrong?
7. When watching your children’s behavior, do you find yourself observing them or judging them?
8. When was the last time you considered your intentions, judgments, and attitude towards your child during an interaction?

Mapping Family Systems

One of the revolutionary tools created by Murray Bowen to understand complicated family relationships is the genogram. A **genogram** is a pictorial representation of a family across generations. Unlike a traditional family tree, a genogram is designed to detail family data and not just basic demographic information (biological sex, birth dates, death dates, etc.). When used effectively, you can track generations of family interactions, medical issues, psychological issues, relationship patterns, and any other variable a researcher or clinician may be interested in studying.³⁶

The standard genogram starts with a couple pairing of some kind. In a genogram, males are

represented by squares and females are represented by circles. Figure 11.5 is a key for common elements in a genogram. Please understand that this is not an exhaustive list. Researchers commonly add symbols to illustrate specific issues of interest. Furthermore, not all of the symbols below are necessarily agreed upon by all researchers who utilize genograms. As such, it's essential to know the key an individual is using when attempting to understand a genogram.

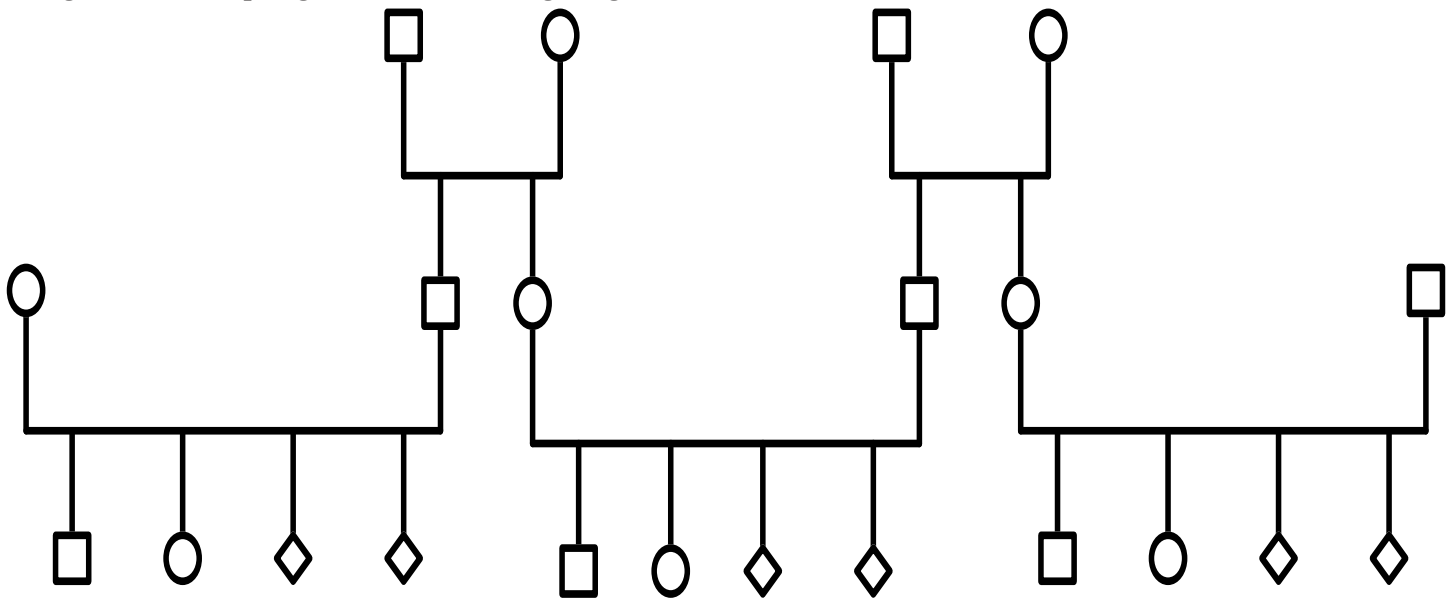

Figure 11.6. Idyllic Family

As you can see in Figure 11.5, your basic genogram allows individuals to look at various basic characteristics of individuals within a family, the types of relationships, types of relationship interactions, and any physical/mental illness and other diseases. When thinking about your average family, many people think of the idyllic family represented in Figure 11.6. In this genogram, we have two heterosexual couples who each have a boy and a girl, who then turn around and have a boy and a girl of their own (and, of course, one dog and one cat). However, most families don't look like this. Families are complicated and messy.

To help us understand genograms, let's look at your typical family, The Skywalkers (Figure 11.7). As you can see, there is a lot going on in this genogram. We have three general familial lines in play within this genogram: The Solo's (to the left), the Skywalker's (in the middle), and the Naberrie's (to the right). We have four generations represented within this genogram. For our purposes, the "index person" is Luke Skywalker (highlighted in the yellow box). For those of you who are unaware, the first trilogy of Star Wars centers around Luke Skywalker, so it makes sense to see him as the index person for our genogram.

Let's examine some of the family interactions. Let's start with Luke and Leia. They are fraternal twins who were separated by birth. Luke is adopted by his uncle Owen Lars and his wife Beru Whitesan. Leia, on the other hand, is adopted by Bail Prestor Organa and Queen Breha Organa. Ultimately, the two do find each other and establish a close relationship as adults, which is why the "cut off repaired" symbol was used between them. Luke also happens to be best friends with Leia's future husband Han Solo. Han has an interesting life before Leia. From what we know, he may have been previously married to Sana Starros (she said they were, he said they weren't). There's also the possibility that Han had an affair with an unknown woman and had a child out of wedlock named Danielle Kieran.

Of course, the bulk of the original trilogy of Star Wars movies centers on the triangle relationship between Luke, Leia, and their father, Anakin Skywalker (also known as Darth Vader). To put it mildly,

Genogram Symbols

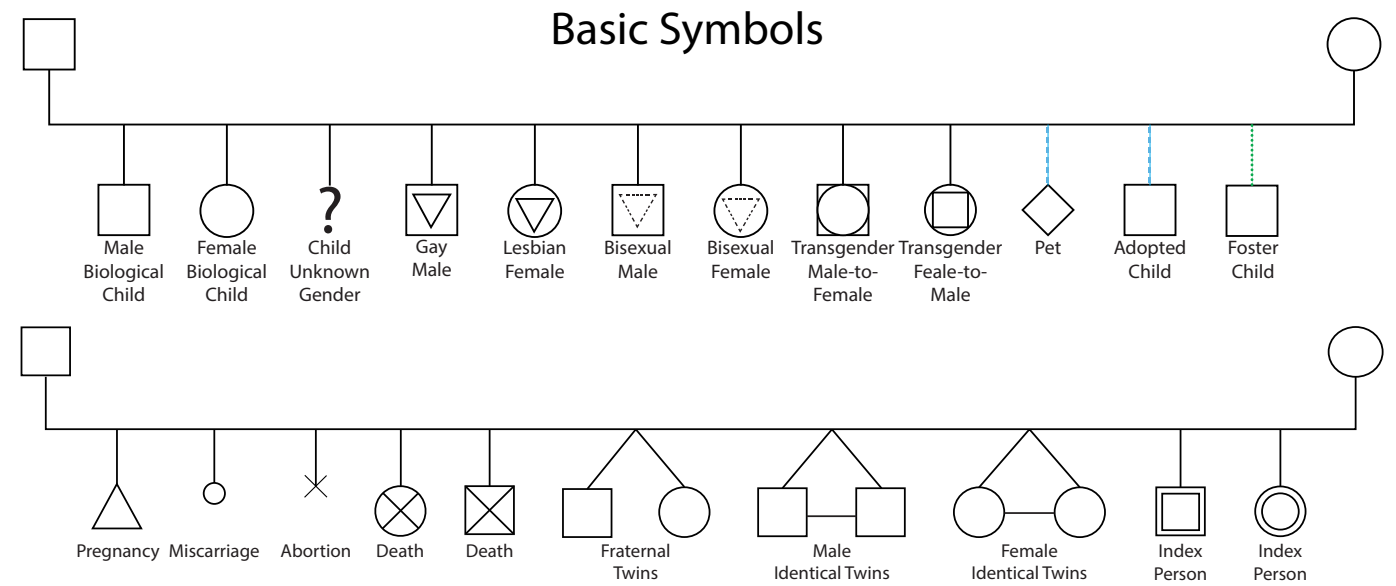

Relationship Types

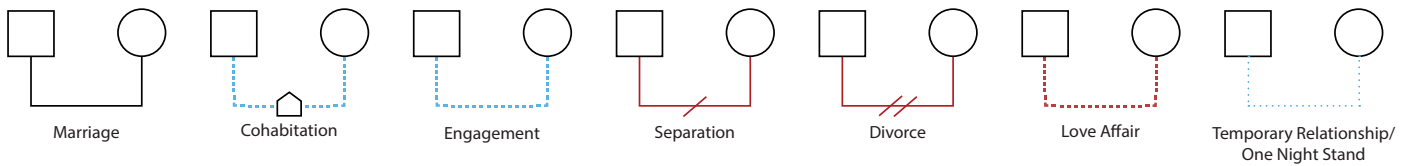

Relationship Interactions

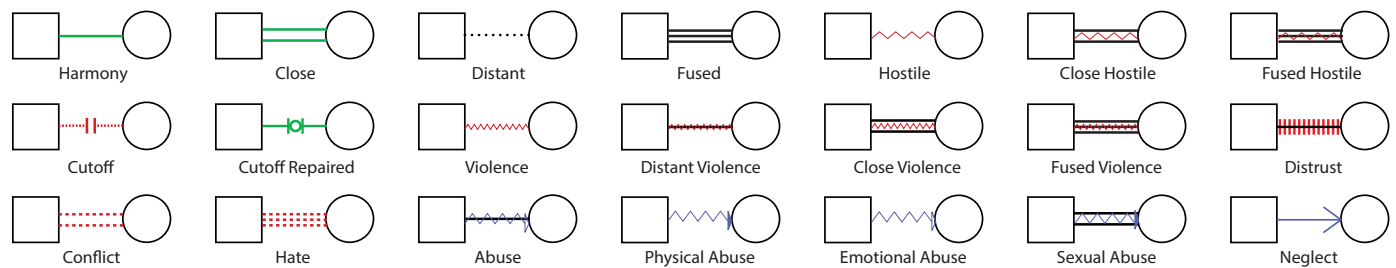

Physical/Mental Illness & Other Diseases

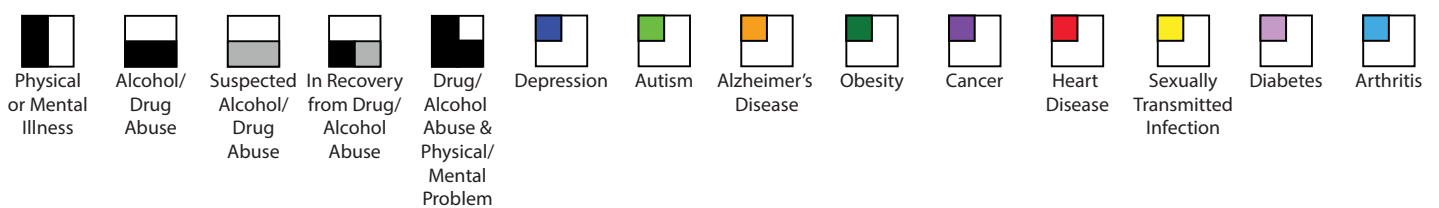

Figure 11.5. Genogram Key

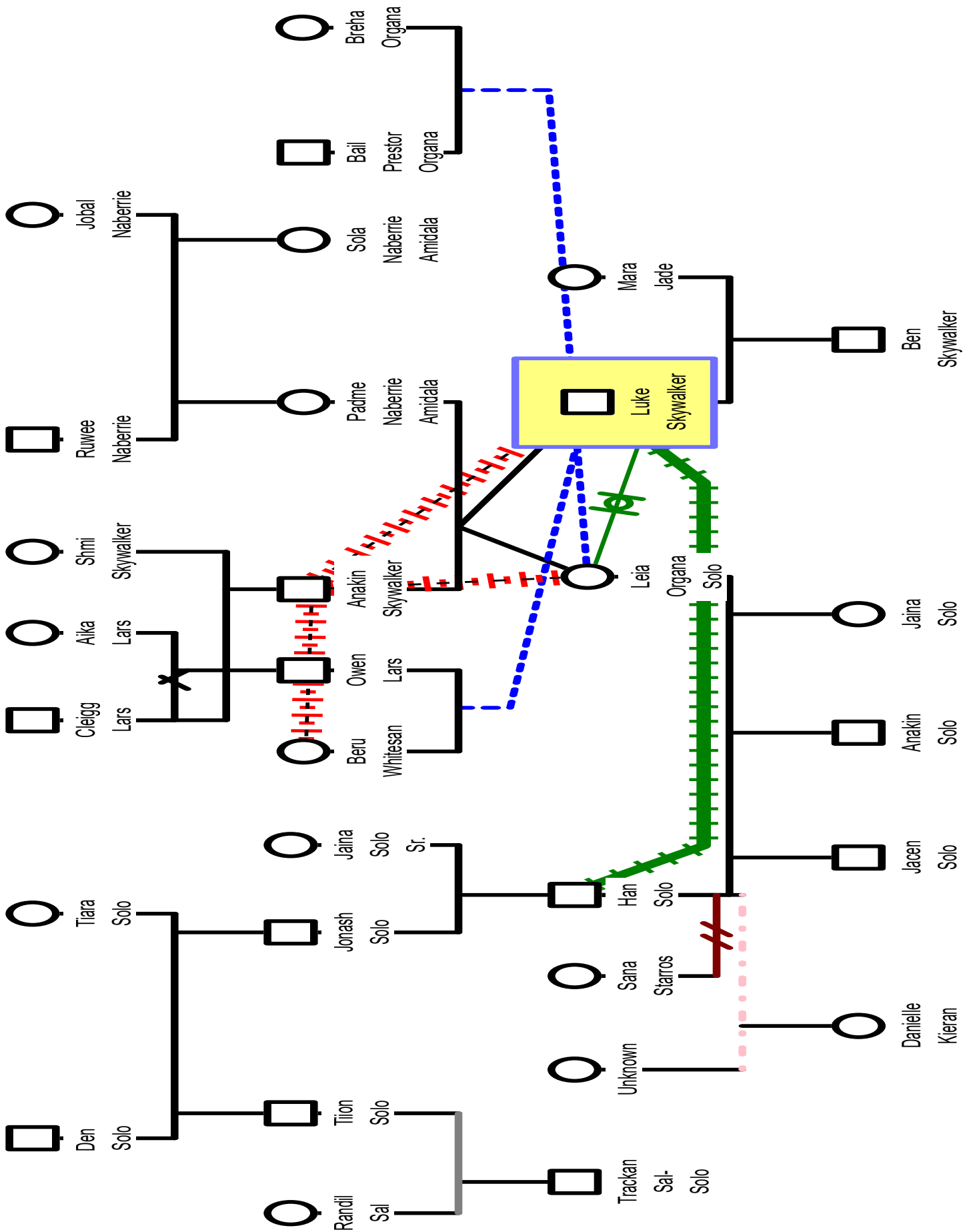

Figure 11.7. The Skywalkers

Vader is a slightly distant father figure and prone to acts of violence. His acts of violence are not only targeted at his children, but also at anyone he perceives to get in his way. During one of his more dramatic acts of violence, Darth Vader destroys the entire planet of Alderaan, which kills Leia's adopted parents in the process. Of course, this is after he gives the order to kill his half-brother Owen and his wife, who were Luke's adopted parents. As we said earlier, families are complicated and messy.

Now, we used the Star Wars world as a tool to help illustrate how genograms can help us breakdown family histories and understand family dynamics. Let's look at a genogram from a real family. The following genogram is created without names, but all parts of the genogram represent an actual family (Figure 11.8).

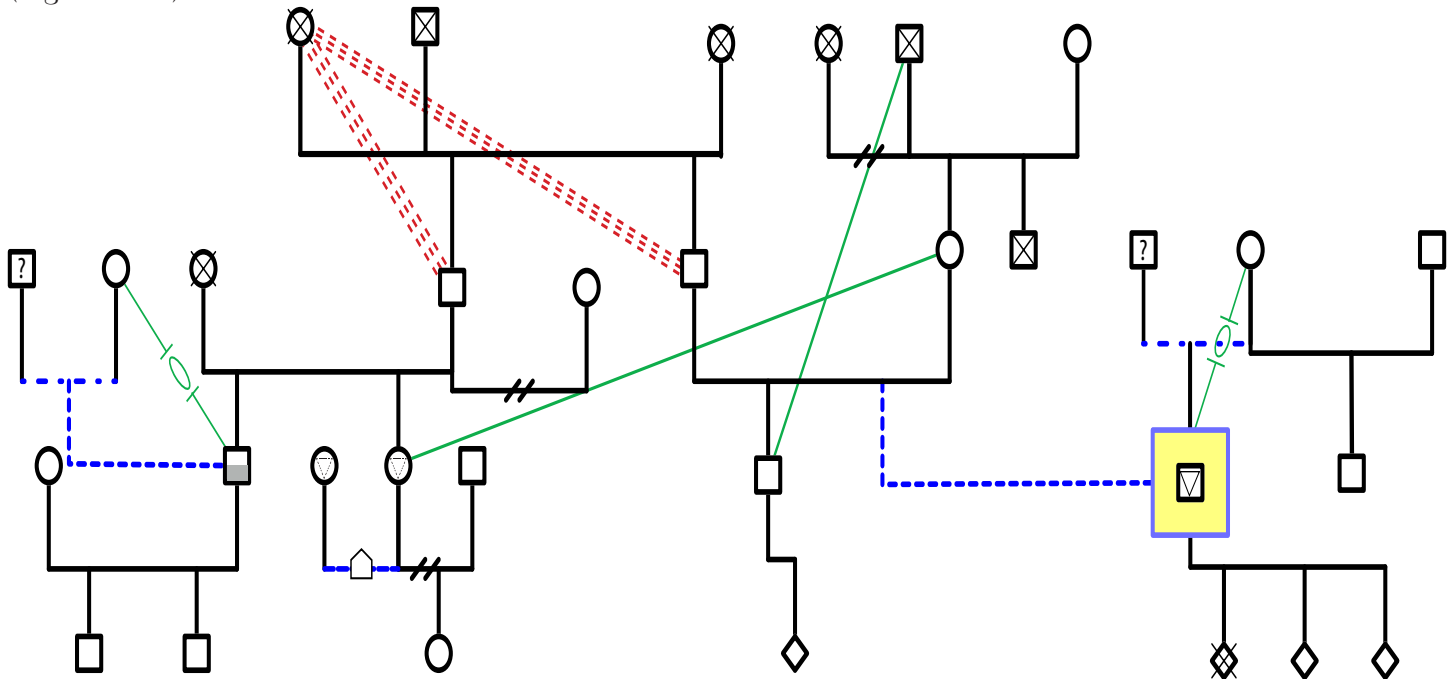

Figure 11.8. Real Family Genogram

Take a few moments and look at this genogram. What do you see? How would you characterize this family? You have a number of close relationships. You have two children who were adopted. Both of whom have repaired the relationships with their birthmothers, but have no apparent connection with their birth fathers. You have single adults with pets. You have three marriages that ended in divorce. For a couple of people, we have no information, which is why we have question marks for two males in the genogram. We have a situation where two male siblings had an intense hatred for their stepmother. We have one gay man who is single and a bisexual woman who is now living with another bisexual woman. We also have one male suspected of alcohol abuse.

We show you this genogram because it's more realistic of how modern families look. Modern family systems aren't always clean and easy to follow. Sure, we could put all of these people on leaves in a family tree, but you would only get a fraction of the picture of what this family looks like. Genograms are an excellent tool for getting a bird's eye view of how a family functions.

Research Spotlight



In 2014, Justin Parent, Jessica Clifton, Rex Forehand, Andrew Golub, Megan Reid, and Emily R. Pichler set out to examine the relationships among parental mindfulness, relationship quality, and parental firm control (“degree to which the parent consistently regulates and monitors the child’s activities and conduct”³⁷). For this study, the researchers specifically examined Black children who had a single mother and the mother had a cohabitating male partner (CMP) who lived with them. The average age of the children participants was 13 years old; the average age of the mother was 39; and the average age of the CMP was 41.

First, the research did not find a relationship between a mother’s mindfulness and her CMP’s mindfulness. For the mothers, mindfulness was positively related to relationship quality, and positively related to parental firm control. For the CMP, mindfulness was positively related to relationship quality, but was not related to parental firm control. We should also mention that mother and CMP relational quality was positively related, and there was a positive relationship between mother and CMP use of parental firm control. The researchers used family systems theory to help explain the CMP’s role within the family system. Specifically, the researchers argue, “It is also important to note that the MCP’s role in different family subsystems may be, at least in part, determined by how a mother defines her male partner’s role. For example, his main role may be to meet her relationship needs and/or contribute to completing general household responsibilities (e.g, grocery shopping, cleaning) rather than setting limits on an adolescent aged child.”³⁸

Parent, J., Clifton, J., Forehand, R., Golub, A., Reid, M., & Pichler, E. R. (2014). Parental mindfulness and dyadic relationship quality in low-income cohabiting black stepfamilies: Associations with parenting experienced by adolescents. *Couple & Family Psychology*, 3(2), 67–82. <https://doi.org/10.1037/cfp0000020>

Key Takeaways

- Although there are numerous definitions for the term “family,” this book uses the following definition: two or more people tied by marriage, blood, adoption, or choice; living together or apart by choice or circumstance; having interaction within family roles; creating and maintaining a common culture; being characterized by economic cooperation; deciding to have or not to have children, either own or adopted; having boundaries; and claiming mutual affection. The family structure is represented by single-mothers, single-fathers, two-parents, and adults living together without children. The idea of family has shifted away from the notion that a family is made up of a mother, father, and children.
- Jack M. McLeod and Steven H. Chaffee originally coined the term “family communication patterns” and broke the concept into two different patterns of family communicative behavior: socio-orientation and concept-orientation. Concept-orientation is the pattern of family communication where freedom of expression is encouraged, communication is frequent, and family life is pleasurable. Conversely, socio-orientation is the pattern of family communication where similarity is valued over individuality and self-expression, and harmony is preferred over expression of opinion.
- Murray Bowen’s family systems theory is an extension of Ludwig von Bertalanffy’s general systems theory. Bowen argued that human behavior is not determined

by social-construction or intra-psychically generated, but is habitual and rooted in billions of years of evolutionary history. As such, to understand how someone behaves or communicates today, it's important to see how this behavior/communication can be understood through generations of family members.

Exercises

- Reflect on your experiences as a family member. How does your own family compare to other families in communication patterns and structure?
- Describe your idea of the ideal family. How would your ideal family communicate? Is this different from your own family?
- Use conformity orientation and conversation orientation to describe two families you know.
- Create your own genogram for your family, including at least three generations. You can create this using a pen and paper, graphic arts software, or genogram software. The genograms used in this book were created using Genogram Pro, <https://www.genopro.com/>. There is also a paired down free version of this software: <https://www.genopro.com/free/>.

11.2 Family Changes

LEARNING OUTCOMES

1. Differentiate among the different stages of a family's life cycle.
2. Explain some of the common problems researchers have identified with family life cycle approaches.

One of the fascinating parts of the study of interpersonal relationships in families is that they are always changing. As the dynamics of a family change, so do the communication networks. For example, a family that starts with a pair of committed adults suddenly becomes a group when they either have their first child, foster their first child, adopt their first child, etc. With the addition of one other life into the family household, the nature and dynamics change almost overnight.

Family Life Cycle

The notion that families go through systematic cycles that resemble other families is nothing new.³⁹ Early research attempted to focus on the differences in families between those that existed in rural and urban settings. One such researcher, Charles Loomis, broke families down into four general categories:

1. Childless couples of child-bearing age
2. Families with children under the age of 14
3. Families with at least one child over the age of 14 but under 36
4. Old families.

Other characteristics that Loomis found could impact the family life cycle were those from the addition of both parents' children and non-parental children (nieces, nephews, etc.). Of course, the age breakdown shown by Loomis primarily had to do with work. Generally, children under the age of 14 were not considered fully capable of work; whereas, those over the age of 14 were considered work-aged. You'll also notice that stage three is generally viewed as the time when a family has the most working adults within the family unit. At this time, especially in rural America, it was assumed that adult children would stay on the homesteads and help with the upkeep and day-to-day duties, whether it was a farm or ranch. These were multi-generational endeavors. Eventually, a family became "old," and the next generation continued the cycle by having their children keep the homesteads running.

Of course, our understanding of how families function has changed quite a bit since the 1930s. Studying family life cycles has been a consistent endeavor across generations of family scholars. For our purposes, we are going to discuss the more recent family life cycle, discussed by David Weaver and Laura Lawton, along with some problems inherently associated with this type of research.⁴⁰

Understanding how families generally function is essential for scholars because it lets us know what major events in someone's life can be predicted. For our purposes, we are going to quickly examine

David Weaver and Laura Lawton's Family Life Cycle (Figure 11.9).

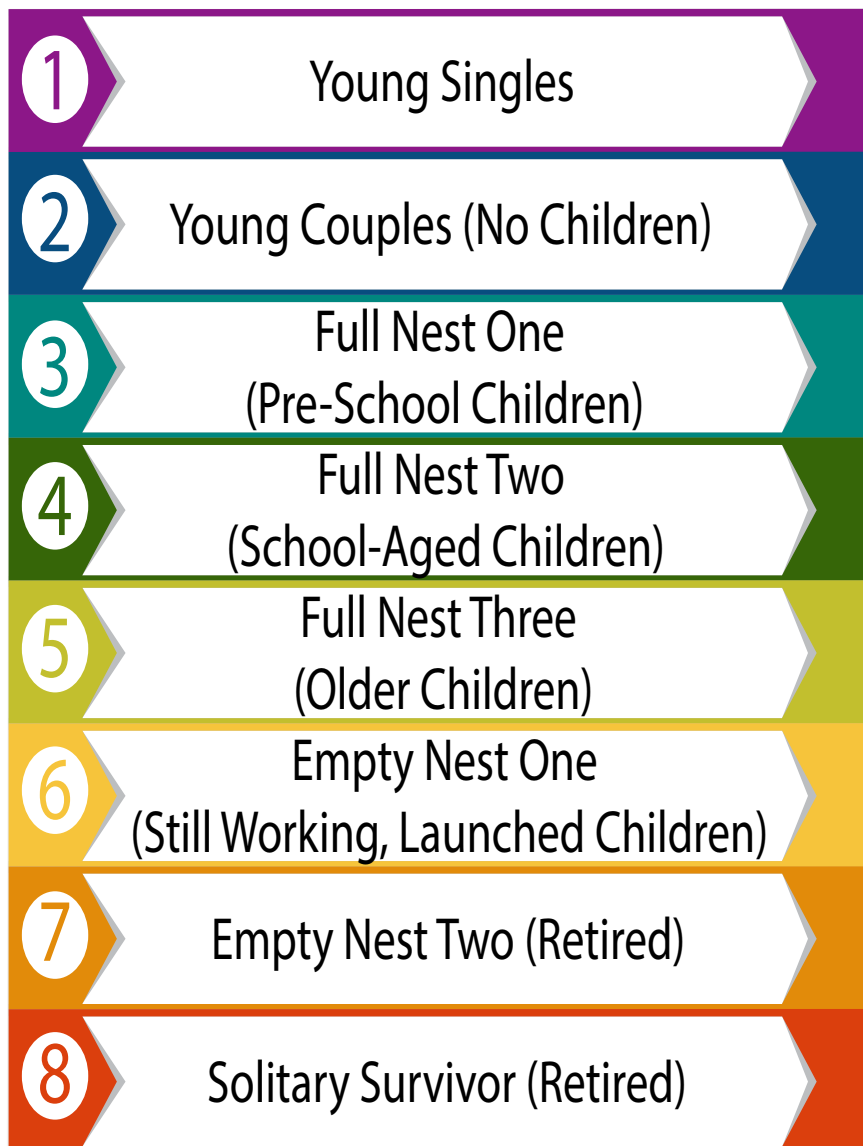

Young Singles

The first stage of any family starts when single people enter in the world and start looking for potential partners. Most people begin to think about this stage when they are around 18 years of age and enter into the world outside of their parents/guardians' house. They go out looking for potential partners through dating and eventual mating. However, we know that in our modern world, this isn't always how this works.

Young Couples (No Children)

Eventually, a couple starts to self-identify as a couple. In today's modern world, we see the couple stage as one that exists with no children. During this time, the focus of the couple is often on developing themselves by going to college or starting a career. Some marketers refer to a couple at this stage as

Figure 11.9. Family Life Cycle

“dinks,” dual incomes, no kids. As you can imagine, dinks are often sought out by marketers because they generally have a higher expendable income level compared to those who do have children or are just starting out.

As couples come together, they enter into a period that many family scholars call third-culture building. Each member of the couple brings with her/him/them a distinct cultural background and upbringing. The more distinct the cultural differences, the easier it is to see where these differences are. For example, maybe you have a couple where one was raised in the Middle East and the other in South America. These two distinct parts of our world have countless numbers of cultural differences that even outsiders can quickly pinpoint. However, all couples’ members can come from different cultural backgrounds, even if the cultures themselves are very similar. For example, you could have a Baptist and a Methodist who were both born and raised in the same town in rural Louisiana. Generally speaking, there may be some minor cultural differences between these two people because of denominational distinctions in their Christian upbringing. Still, these differences aren’t huge (though some may overexaggerate them). But even in these cases where people are very similar, there will be cultural differences that exist that must be dealt with as the couple comes together.

When a couple negotiates their cultural background with the cultural background of their partner, they are building a new “**third-culture.**” Sometimes these cultural differences can be very small. Maybe one member of the couple always opens presents on Christmas Day, and the other member of the couple always opens presents on Christmas Eve. The couple could decide to open one present on Christmas Eve and the rest on Christmas Day. In this case, the couple has negotiated their cultural differences to create a new pattern. Other cultural differences can be much larger. In our example of the couple from the Middle East and South America, we could have the need to negotiate the religious upbringing of a children in the Islamic and Roman Catholic faiths. Maybe the couple is atheist, and will not include any kind of religious teaching into the rearing of children, or the couple could opt for some type of combination of both. It’s also entirely possible that one member of the couple will convert to the other member’s religion to ensure religious upbringing in a specific faith.

Ultimately, third-culture building is a unique part of any couple. Some couples will have fairly minor cultural differences to negotiate, while other couples could have very large cultural differences to negotiate. The important part is that this is a negotiation by the couple.

Full Nest One (Pre-School Children)

Once a couple decides to involve children, Weaver and Lawton break this phase into three distinct categories or stages depending on the age of the children. The first stage with children (full nest one) occurs when a couple has pre-school aged children. Pre-school age children require more parental oversight. We also see couples with children starting to associate more and more with other couples who also have children, which can cause changes to a couple’s social network. Other couples may become very dependent on both their nuclear and extended family for child-rearing help. In contrast, others depend on paid help in the forms of nannies or daycare facilities. When the initial couple consists of dual-income earners, these extended networks become paramount for the ability of the couple to maintain their occupations.

Full Nest Two (School-Aged Children)

In full nest two, the couple has children who are now in school. Once kids go to school, a good chunk of their day is spent in the care of adults outside of the nuclear or extended family. For this reason, the

traditional workday tends to be somewhat more flexible for these parents/guardians, but their evenings and weekends are often filled with family functions. As children grow older, parental oversight and direction become less necessary, but children also start taking on their own busy lives and schedules that often conflict with their parents/guardians' lives and schedules.

Full Nest Three (Older Children)

In full nest three, the couple's children are older and more and more independent; however, they are still somewhat dependent upon their families for food and shelter. As children try to increasingly demand their own identities apart from their parents/guardians, parent/guardian-child relationships are often fraught with various degrees of conflict. On the one hand, you have parents/guardians who have been in a parental oversight role for many years, and on the other, you have children who are seeking their own independence and autonomy. Finding the balance between these polarizing forces is often easier said than done for many families.

Empty Nest One (Still Working, Launched Children)

The next stage is empty nest one, which happens once children are launched, but the parents/guardians are still working. The **launching stage** occurs when late adolescents leave the parental home and venture out into the world as young singles themselves. Historically, late adolescents started the launching stage when they exited the home and went off to college.

However, it's possible that going to college is only a partial-launch. In today's world, many adolescents go off to college and then after college find it almost impossible to function in many large cities on a single salary, so they end up back at home living with their parents/guardians. At the same time, adolescents seek to achieve economic security, but some find it impossible to do so, depending on what's going on within our economy. For example, after the economic downturn of 2008, many recent college graduates had a tough time finding entry-level jobs because they were competing against people with decades of experience who had lost their jobs and desperately needed work (even entry-level work). As I'm writing this, we're seeing the same problem once again as a result of the 2020 Pandemic.

As I'm writing this sentence, we're just at the beginning of the global economic disaster stemming from the COVID-19 outbreak of 2019-2020. Many experts are predicting that we could be looking at a period of economic unease not seen since the Great Depression started in 1929. If this economy does dive into a depression, we'll see more and more late adolescents forced to live longer and longer with their parents/guardians out of economic necessity. Although it was simply too early, in March 2020, to tell what would happen, experts predicted that 80 million jobs are at moderate to high risk of disappearing (more than half the jobs in the U.S. today).⁴¹ By the height of the first wave, around 31 Million U.S. Citizens were filing for unemployment as a result of COVID-19.⁴²

Eventually, most parents/guardians will experience a period when their adult children have launched, and the parents/guardians, themselves, are still working.

Empty Nest Two (Retired)

Empty nest two occurs once both parents/guardians have decided to retire. Now, retirement is one of those options that may not be viable for everyone, so some couples never end up in empty nest two as a necessity. Other couples spend almost the last third of their lives in retirement. In many ways, couples in retirement have a lot of the same flexibility they had when they were young couples.

Solitary Survivor (Retired)

The typical final stage in the family life cycle is when one partner passes away, leaving the other partner on her/his/their own. In essence, an individual suddenly finds her/him/themself older, and yet again, single.

Problems with Life Cycle Research

Probably the most apparent problem with the traditional approach to the family life cycle is that it does not take into account a wide range of differing family possibilities. For example, Elisa Backer noted several other options that could exist outside of the traditional family cycle:

- Young singles (less than 35 years old)
- Young couples (no children) (female less than 35 years old)
- Gay couple (no children)
- Gay couple (with children)
- Older couple (no children) (female 35+ years of age)
- Older retired couple (no children from current marriage)
- Age-gap couple (children from current relationship; with or without children from previous relationship)
- Age-gap couple (no children from current relationship; with or without children from previous relationship)
- Older divorced single (no children)
- Single parent (children still at home)
- Older single (never been married, no children) (35+ years old)
- Couple with pre-school children (youngest child not at school)
- Couple with school-aged children (youngest child at school)
- Couple with older children (all children finished school)
- Empty Nest I (still working, children left home)
- Empty Nest II (retired, children left home)
- Widower (widower who is not working and partner is deceased)
- Widower (still working)⁴³

Another commonly discussed problem with this approach to understanding the family life cycle is that many individuals do not walk through the family life cycle in an exact sequence. For example, someone could be single, get married, get divorced, get married again, have a child, lose a partner, get remarried, have another child (one child is pre-school age one is recently launched), etc. Suddenly, we've gone from a path that seems highly "normalized" and straightforward to one that contains a lot more uncertainty and diversions from the typical path of "family."

As a whole, family life cycles are an excellent tool for having a general understanding of how many families function within society, but many families do not experience the life cycle as a linear process from singlehood to death.

Key Takeaways

- David Weaver and Laura Lawton's Family Life Cycle consists of eight distinct stages: 1) young singles, 2) young couples (no children), 3) full nest one (pre-school children), 4) full nest two (school-aged children), 5) full nest three (older children), 6) empty nest one (still working, launched children), and 7) empty nest two (retired).
- Although the concept of family life cycles is a useful tool for examining families, there are some inherent limitations to this approach. First, the life cycle doesn't allow for different types of family units. Additionally, many individuals do not walk through the family life cycle in an exact sequence.

Exercises

- Use the idea of a family life cycle to map out the cycle of a famous family. You want to choose a family that has completed the full cycle to make this activity easier. Once you've mapped out the family, answer the following questions. Did the life cycle fit this family? How easy was it to determine the different parts of the family life cycle? What critiques would you have of the applicability of the family life cycle approach to this specific family?
- Think about your own family's life cycle. Attempt to plot out the life cycle of your family through at least three generations: your grandparents (or equivalent), your parents (or equivalent), and yourself and any siblings (or equivalent).

11.3 Sibling Types

LEARNING OUTCOMES

1. Explain the two main concepts Shirley McGuire, Susan M. McHale, and Kimberly Updegraff found in research related to siblings.
2. Differentiate among Shirley McGuire, Susan M. McHale, and Kimberly Updegraff's different sibling relationship types.
3. Describe different ways that siblings maintain their relationships.

1

After examining the literature related to siblings, Shirley McGuire, Susan M. McHale, and Kimberly Updegraff realized that two main concepts were commonly discussed in the literature: hostility and warmth.⁴⁴ **Sibling hostility** was characterized by such sibling behaviors as causing trouble, getting into fights, teasing/name-calling, taking things without permission, etc.⁴⁵ **Sibling warmth**, on the other hand, was characterized by sibling behaviors such as sharing secrets, helping each other, teaching each other, showing physical affection, sharing possessions, etc.⁴⁶ Research has shown us that warmth and hostility have an impact on sibling relationships. For example, individuals who have higher levels of sibling

warmth are more likely to engage in prosocial behavior.⁴⁷ Individuals who have sibling relationships that are high in hostility are more likely to report higher levels of aggression, anxiety, depression, and loneliness.⁴⁸

Sibling Relationship Types

McGuire, McHale, and Updegraff knew that these two dimensions were distinct from one another, so they set out to create a typology of sibling relationships based on hostility (high vs. low) and warmth (high vs. low). You can see this typology in Figure 11.10.

Harmonious

The first type of sibling relationship is the harmonious relationship. Harmonious sibling relationships are characterized by low levels of hostility and high levels of warmth. In these relationships, the siblings get along very well and have very low levels of problematic conflict. Often siblings in this category get along so well that they are very close friends in addition to being siblings. When it comes to long-term outcomes, harmonious siblings were found to have lower feelings of loneliness and higher self-esteem.⁴⁹ Research has also found gender effects. When sibling pairs are both female, they are more likely to report harmonious relationships than the other three sibling relationship types. At the same time, the combination of gender and birth-order also makes a difference. Males who are the firstborn are less likely to report harmonious sibling relationships.⁵⁰

Hostile

The opposite type of the harmonious sibling relationship is the hostile sibling relationship, which is characterized by high levels of hostility and low levels of warmth. These relationships are marked by high levels of conflict between the siblings, which can often be highly physically and verbally aggressive. Furthermore, individuals in hostile sibling relationships are more likely to internalize problems as well as experience lower academic success, social competence, and feelings of self-worth.⁵¹ These people often perceive their siblings as rivals within the family unit, so there is an inherent competition for scarce resources. Often these resources are related to parental attention, respect, and love.

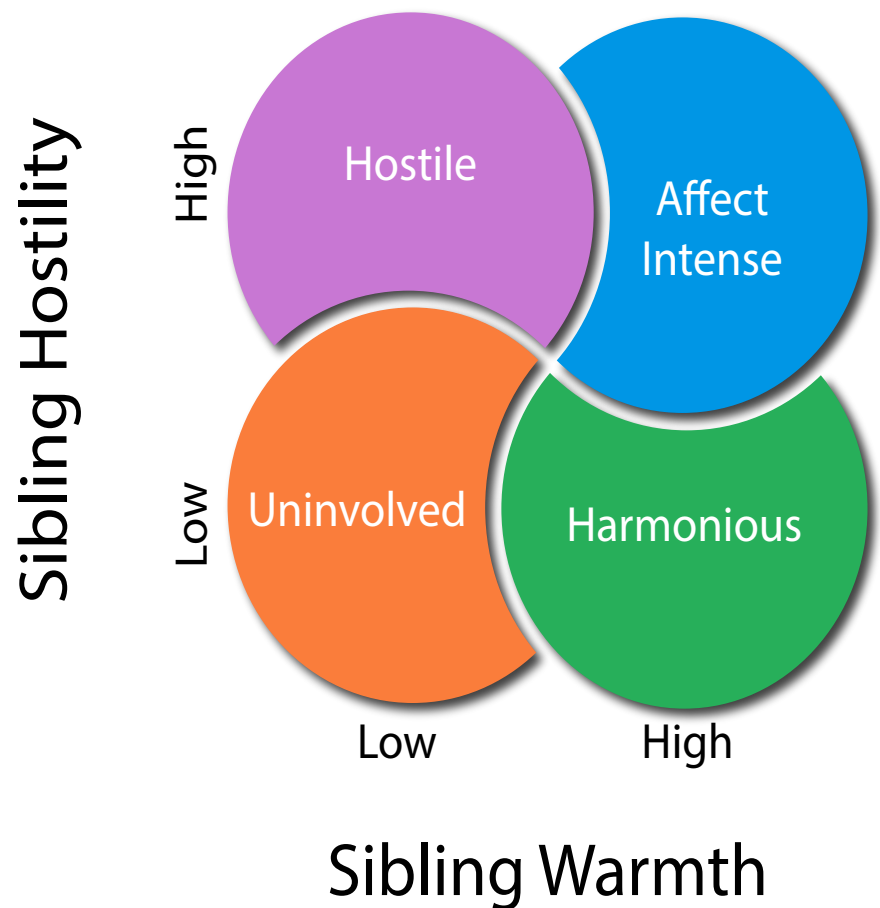

Figure 11.10. Sibling Relationships

Affect-Intense

The third sibling type is the affect-intense relationship. Affect-intense sibling relationships are marked by both high levels of hostility and warmth. These sibling relationships are as nurturing as harmonious relationships and as dominating as hostile relationships. These relationships are also perceived as more satisfying than hostile sibling relationships.⁵² In one study examining affect-intense sibling relationships, researchers found that 38% of siblings from divorced families reported their sibling relationships as affect-intense as compared to only 22% of siblings from intact families.

Uninvolved

The last type of sibling relationship is called the uninvolved, which is characterized by low levels of both hostility and warmth. Uninvolved sibling relationships typically don't have any of the problems associated with affect-intense or hostile sibling relationships. They also do not report any of the benefits that have been found with harmonious sibling relationships.⁵³ Uninvolved sibling relationships also appear to develop later in life. "Perhaps the separation processes and increased focus on peers that begin during adolescence stimulate the development of an uninvolved sibling relationship."⁵⁴

Sibling Relationship Maintenance

One area where communication scholars have been instrumental in the field of sibling relationships has been in relationship maintenance, or the communicative behaviors that one engages in to preserve a relationship with another person. In one of the earliest studies to examine sibling relationships in the field, Scott Myers and a group of students explored the connection between relationship communication and sibling communication satisfaction, liking, and loving.⁵⁵ Equality, receptivity, immediacy, similarity, and composure were all positively related to communication satisfaction. Composure, equality, similarity, and receptivity were all positively related to sibling liking. Equality, similarity, and receptivity were positively related to loving one's sibling. The researchers also noted that individuals who perceived their relationships as more formal reported lower levels of loving their siblings. This first study helped pave the way for future research in examining how relationship communication impacts sibling relationships.

In a follow-up study, Scott Myers and Keith Weber set out to construct a measure for analyzing how individuals use communication to maintain their sibling relationships.⁵⁶ In their research, Myers and Weber found six distinct ways that siblings maintain their relationships through communication: confirmation, humor, social support, family visits, escape, and verbal aggression

Confirmation

The first way that siblings engage in relational maintenance is through confirmation. Confirmation messages help a sibling communicate how much they value the sibling. Sometimes it's as simple as telling a sibling, "I'm pretty lucky to have a brother/sister like you." This sentence can be an easy way to demonstrate how much someone means to you. These types of messages help validate the other sibling and the relationship.

Humor

A second relational maintenance tool that siblings can use is humor. Being able to laugh with one's

sibling is a great way to enjoy each other's company. Often siblings find things completely hilarious that outsiders may not understand because of the unique nature of sibling relationships. Siblings also can lovingly make fun of each other. Now, we're not talking about making fun of someone in a demeaning or mean-spirited manner. For example, one of our coauthors has an older brother who loves to give him a hard time. Recently, our coauthor misspelled something on Facebook, and his brother was right there to point it out and give him a hard time. In some relationships, this could be viewed as criticism, but because of the nature of their relationship, our coauthor knew the incident should be taken in jest.

Social Support

The third way siblings engage in relational maintenances is through social support. Social support is an individual's perception and the actuality that an individual is loved and cared for and has people he/she/they can turn to when assistance or help is needed. Between siblings, this could involve conversations about one's romantic life or even about parental concerns. Another way that siblings often provide social support is by giving and seeking advice from her/his/their sibling(s).

Family Events

The fourth way that families engage in social support is through family events. Not all families are big on family events, but some families participate in close-knit gatherings regularly. Some siblings will avoid these events to avoid seeing their other siblings, but many siblings see these opportunities as a way to keep their sibling relationships going. One of our coauthor's family has problems getting together each year during the holidays because of how busy their schedules are in December. Instead, our coauthor and family go on family trips. Over the years, they've gone to Australia, Alaska, Hawaii, The Bahamas, San Francisco, New York City, New Zealand, and many other places. Currently, they're planning trips to Belize and back to Hawaii. The family looks forward to these vacations together. In addition to these trips, our coauthor's father also arranges periodic family reunions for his side of the family. Our coauthor and their sibling often end up rooming together because both are single. Ultimately, both look forward to these reunions because it gives them a chance to catch up.

Escape

It's often great to attend family events, but we usually only like to attend when we know our sibling will be there. In these cases, we often use our siblings as a form of escape. In fact, some siblings will only attend family get-togethers when they know their sibling(s) will be there. We often have a range of reasons for why we need to escape when we're interacting with our family, but we are sure glad our sibling(s) are there when we need that escape.

Verbal Aggression

The final relational maintenance strategy that siblings have been found to use is verbal aggression. Verbal aggression is generally not viewed as a positive tool for communication. However, some sibling pairs have realized over time that verbally aggressive behavior allows them to get their way or vent their frustrations. However, in the original study by Weber and Myers, the researchers did find that all of the other relational maintenance strategies were positively related to sibling liking, commitment, and trust, but verbal aggression was not.⁵⁷

Key Takeaways

- Shirley McGuire, Susan M. McHale, and Kimberly Updegraff examined the literature related to siblings and found that there were two common variables: hostility and warmth. Sibling hostility is characterized by such sibling behaviors as causing trouble, getting into fights, teasing/name-calling, taking things without permission, etc.... Sibling warmth, on the other hand, is characterized by sibling behaviors such as sharing secrets, helping each other, teaching each other, showing physical affection, sharing possessions, etc.
- Shirley McGuire, Susan M. McHale, and Kimberly Updegraff found four sibling relationship types. The four different types of sibling relationships are based on the degrees to which they exhibit the combination of hostility and warmth. First, harmonious sibling relationships are characterized by low levels of hostility and high levels of warmth. Second, hostile sibling relationships are characterized by high levels of hostility and low levels of warmth. Third, affect-intense sibling relationships are characterized by both high levels of hostility and warmth. Lastly, uninvolved sibling relationships are characterized by low levels of both hostility and warmth.
- Scott Myers and Keith Weber discovered that siblings generally maintain their relationships using several relational maintenance strategies: confirmation, humor, social support, family visits, escape, and verbal aggression.

Exercises

- Think about your sibling relationships. How would you describe your sibling relationships using the four different types of sibling relationships discussed by Shirley McGuire, Susan M. McHale, and Kimberly Updegraff? If you don't have siblings, think of a famous pair of siblings. Based on what you know about their relationship, how would you describe their relationship using the four different types of sibling relationships discussed by Shirley McGuire, Susan M. McHale, and Kimberly Updegraff?
- Think about your sibling relationships. What relational maintenance strategies discussed by Scott Myers and Keith Weber do you use with your siblings? If you don't have siblings, think of a famous pair of siblings. Based on what you know about their relationship, what relational maintenance strategies do these famous siblings use?

11.4 Marriage Relationships

LEARNING OUTCOMES

1. Describe the marriage relational dimensions discussed by Mary Anne Fitzpatrick.
2. Explain the three different types of marital relationships described by Mary Anne Fitzpatrick.
3. Discuss the application of Mary Anne Fitzpatrick's relational dimensions to same-sex marriages.

Earlier in this text, we discussed dating and romantic relationships. For this chapter, we're going to focus on marriages as a factor of family communication. To help us start our conversation of marriage, let's look at some sage wisdom on the subject:

- “Marriage has no guarantees. If that’s what you’re looking for, go live with a car battery.”
– Erma Bombeck
- “The trouble with some women is that they get all excited about nothing - and then marry him.”
– Cher
- “I love being married. It’s so great to find that one special person you want to annoy for the rest of your life.”
– Rita Rudner
- “By all means, marry. If you get a good wife, you’ll become happy; if you get a bad one, you’ll become a philosopher.”
– Socrates
- “Marriage is an endless sleepover with your favorite weirdo.”
– Unknown
- “Many people spend more time in planning the wedding than they do in planning the marriage.”
– Zig Ziglar

Many writers, comedians, political figures, motivational speakers, and others have all written on the subject of marriage. For our purposes, we are going to examine marital types and the research associated with the Prepare/ENRICH studies.

Marital Types

One of the most important names in the area of family communication and marital research, in general, is a scholar named Mary Anne Fitzpatrick. Fitzpatrick was one of the first researchers in the field of communication to devote her career to the study of family communication. Most of her earliest research was in the area of marriage. The culmination of her earliest research on the subject was the publication of her important book, *Between Husbands and Wives: Communication in Marriage* in 1988.⁵⁸ Although this book is over 30 years old now, the information she found and discussed in this book is still highly relevant to our understanding of marital relationships and marital communication.

Relational Dimensions

One of the earliest projects undertaken by Mary Anne Fitzpatrick was the creation of the Relational Dimensions Instrument. The creation of the measure started as part of her dissertation work in 1976,⁵⁹ and was originally fleshed-out in a series of articles.^{60,61} The RDI originally consisted of 200 items based on different ideas expressed in the literature about marriage at the time. Through her research, Fitzpatrick was able to fine-tune the measure to identify eight dimensions of marriage measured by 77 items. These eight dimensions fall into three larger categories: conventional versus nonconventional ideology, interdependence/autonomy, and conflict engagement/avoidance. The RDI can be seen in its entirety in a couple of different locations.⁶²

Conventional vs. Nonconventional Ideology

The first large category of relational dimensions is what Fitzpatrick called ideologies. In this category, Fitzpatrick recognized two different ideologies traditionalism and uncertainty and change.

Ideology of Traditionalism

The first dimension is referred to as the **ideology of traditionalism**. Traditionalism is the idea that a couple has a very historically grounded and conservative perspective of marriage. For example, couples who see themselves as more traditional are more likely to believe that a wife should take her husband's name when they get married. They are also more likely to think that the family should adhere to specific religious traditions and that children should be taught those traditions when growing up. Generally speaking, people with a traditional ideology are going to believe in a more rigid understanding of both the male and female roles within a marriage. As for specific communication issues associated with this ideology, there is a strong belief that families should look composed and keep their secrets to themselves. In other words, families should strive to keep up appearances and not talk about any of the issues going on within the family itself.

Ideology of Uncertainty and Change

The underlying idea of the ideology of uncertainty and change is basically the notion that people should be open to uncertainty. "Indeed, the ideal relationship, from this point-of-view, is one marked by the novel, the spontaneous, or the humorous. The individuals who score highly on this factor seem open to change. They believe that each should develop their potential, and that relationships should not constrain an individual in any way."⁶³

Interdependence vs. Autonomy

The second large category of relational dimensions is what Fitzpatrick called the struggle of interdependence versus autonomy. In every relationship, as people grow closer, there is the intertwining of people's lives as they become more interdependent. At the same time, some people prefer a certain amount of individuality and autonomy outside of the relationship itself. "To figure out how connected spouses are, one has to look at the amount of sharing and companionship in the marriage as well as at the couple's organization of time and space. The more interdependent the couple, the higher the level of companionship, the more time they spend together, and the more they organize their space to promote togetherness and interaction."⁶⁴

Sharing

The third dimension of marriage relationships is sharing. Sharing consists of two basic components. The first component involves discussing the affective or emotional health of each of the partners and the relationship while exhibiting nonverbal affective displays (e.g., touching holding hands in public). The second component expands across the other dimensions. “A high score on this factor would suggest an open sharing of love and caring, and the tendency to communicate a wide range and intensity of feelings. There is a sharing of both task and leisure activities, as well as a considerable degree of mutual empathy. Finally, these relational partners not only visit with friends but also seek new friends and experiences.”⁶⁵

Autonomy

Autonomy is an individual’s independence in their own behaviors and thoughts. In a marriage relationship, autonomy can include having a “man cave” or a home office that is specified as “personal” space for one of the marriage partners. Some couples will even go on separate vacations from one another. In any relational dialectic, there is always the struggle between connectedness and autonomy. Different couples will place differing degrees of importance on autonomy.

Undifferentiated Space

The fifth dimension of marital relationships is **undifferentiated space**, or the idea that there are few constraints on physical spaces within the home. This undifferentiated space means that spouses do not see her/his/their ownership of personal belongings as much as they do ownership as a couple. Furthermore, individuals who score high in undifferentiated space are also more willing to open their homes to family and friends. On the other hand, individuals who have a low undifferentiated space generally see belongings in personal terms. “That’s my room.” “That’s my pen. “This is my mail.” Etc. These individuals are also more protective of their personal space from outsiders. When they do allow outsiders (e.g., family and friends) into the house, they want to forewarn the outsiders that this will happen and may limit access to parts of the house (e.g., office spaces, workshops, master bedrooms, master bathrooms).

Temporal Regularity

The next dimension, **temporal regularity**, examines strict a schedule couples stick to. Do they always get up at the same time? Do they always go to bed at the same time? Do they always eat their meals at the same time? Some marriages run like a well-scheduled train, while other marriages fluctuate temporally daily.

Conflict Engagement vs. Avoidance

The final broad category of relational dimensions examines how couples handle conflict. Some couples will actively avoid conflict, while others openly engage in conflict.

Conflict Avoidance

The seventh dimension of marital relationships is conflict avoidance. Couples who engage in conflict avoidance do not openly discuss any conflicts that occur within the marriage. Individuals who avoid conflict will even avoid expressing their true feelings about topics that could cause conflict. If, and when,

they do get angry, they will hide that emotion from their spouse to avoid the conflict.

Assertiveness

The final relational dimension is assertiveness. When analyzing the items on the Relational Dimensions Instrument, Fitzpatrick noticed that two different patterns emerged. First, she saw a pattern of the use of persuasion or influence to get a partner to do specific things (e.g., watch a TV show, read a book/magazine). At the same time, there is a sense of independence and the desire to stand up for oneself even front of friends. Ultimately, Fitzpatrick believed that “assertiveness” was the best term to capture both of these phenomena.⁶⁶

The Relational Definitions

After creating the relational dimensions, Fitzpatrick then further broke this down into a marriage typology that included three specific marriage types: traditional, independents, and separates.⁶⁷ Figure 11.11

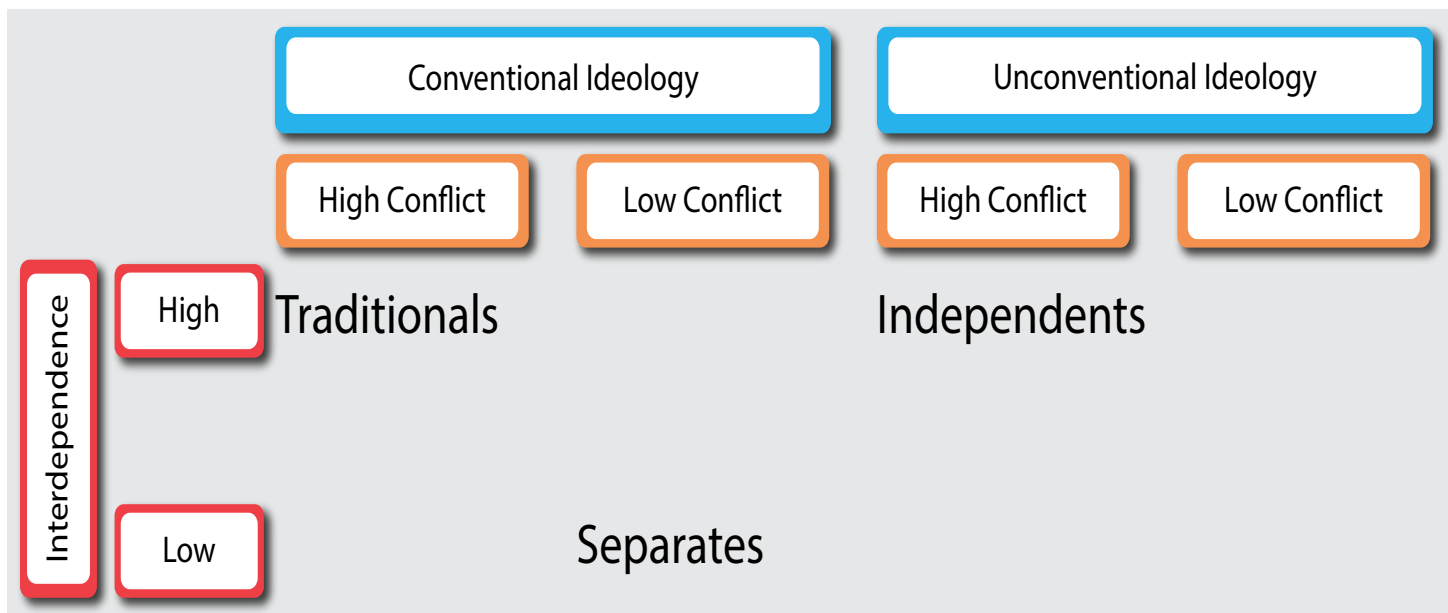

Figure 11.11. Relational Definitions

illustrates how the three relational definitions were ultimately arrived at.

Traditionals

The first relational definition that Fitzpatrick arrived at was called traditionals. **Traditionals** are highly interdependent, have a conventional ideology, and high levels of conflict engagement. First, traditional lives are highly intertwined in both the use of space and time, so they are not likely to feel the need for autonomous space at home or an overabundance of “me time.” Instead, these couples like to be with each other and have a high degree of both sharing and companionship. These couples are more likely to have clear routines that they are happy with. These couples are traditionals also because they do have a conventional ideology. As such, they believe that a woman should take her husband’s name, keep family plans when made, children should be brought up knowing their cultural heritage, and infidelity is never excusable. Lastly, traditionals report openly engaging in conflict, but they do not consider themselves

overly assertive in their conflict with each other. Of the three types, people in traditional marriages report the greatest levels of satisfaction.

Independents

The second relational definition that Fitzpatrick described was called independents. **Independents** have a high level of interdependence, an unconventional ideology, and high levels of conflict engagement. The real difference is their unconventional values in what a marriage is and how it functions. Independents, like their traditional counterparts, have high levels of interdependency within their marriages, so there is a high degree of both sharing and companionship reported by these individuals. However, independents tend to need more “me time” and autonomous space. Independents are also less likely to stick with a clear daily family schedule. To these individuals, marriage is something that compliments their way of life and not something that constrains it. Lastly, independents are also likely to openly engage in conflict and report moderate levels of assertiveness and do not avoid conflicts.

Separates

The final relational definition that Fitzpatrick described was called separates. **Separates** have low interdependence, have a conventional ideology, and low levels of conflict engagement. “Separates seem to hold two opposing ideological views on relationships at the same time. Although a separate is as conventional in marital and family issues as a traditional, they simultaneously support the values of independents and stress individual freedom over relational maintenance.”⁶⁸ Ultimately, these couples tend to focus more on maintaining their individual identity than relational maintenance. Furthermore, these individuals are also likely to report avoiding conflict within the marriage. These individuals generally report the lowest levels of marriage satisfaction of the three.

Same-Sex Marriages

Up to this point, the majority of the information discussed in this section has been based on research explicitly conducted looking at heterosexual marriages. In one study, Fitzpatrick and her colleagues specifically set out to examine the three relational definitions and their pervasiveness among gay and lesbians.⁶⁹ Ultimately, the researchers found that among “gay males, there are approximately the same proportion of traditionals, yet significantly fewer independents and more separates than in the random, heterosexual sample. For lesbians, there were significantly more traditionals, fewer independents, and fewer separates than in the random, heterosexual sample.”⁷⁰ However, it’s important to note that this specific study was conducted just over 20 years before same-sex marriage became legal in the United States.

The reality is that little research exists thus far on long-term same-sex marriages. The legalization of same-sex marriages in July 2015 started a new period in the examination of same-sex relationships for family and family communication scholars alike.⁷¹ As a whole, LGBTQIA+ families, and marriages more specifically, is an under-researched topic. In a 2016 analysis of a decade of research on family and marriage in the most prominent journals on the subject, researchers found that only.02% of articles published during that time period directly related to LGBTQIA+ families.⁷² For scholars of interpersonal communication, the lack of literature is also problematic. In an analysis of the *Journal of Family Communication*, of the 300+ articles published in that journal since its inception in 2001, only nine articles have examined issues related to LGBTQIA+ families. This is an area that future scholars, maybe even

you, will decide to study.

Key Takeaways

- Mary Anne Fitzpatrick started researching marriage relationships in the late 1970s. Her research found a number of specific relational dimensions that couples can take: conventional/nonconventional ideology, interdependence/autonomy, and conflict engagement/avoidance.
- Mary Anne Fitzpatrick described three specific relational definitions. First, traditional are couples who are highly interdependent, have a conventional ideology, and high levels of conflict engagement. Second, independents are couples who have a high level of interdependence, an unconventional ideology, and high levels of conflict engagement. Lastly, separates are couples who have low interdependence, a conventional ideology, and low levels of conflict engagement.
- Little research has examined how LGBTQIA+ couples interact in same-sex marriages. Research has shown that in a decade of studies about family and marriage, only .02% articles had to do with LGBTQIA+ families. In the field of communication, out of the 300+ studies published in the *Journal of Family Communication*, only nine of them involved LGBTQIA+ families. In the one study that examined Mary Anne Fitzpatrick's relational dimensions among same-sex couples, the researchers found that gay males had approximately the same proportion of traditionals, yet significantly fewer independents and more separates than in the random, heterosexual sample. Conversely, among lesbian women there were significantly more traditionals, fewer independents, and fewer separates than in the random, heterosexual sample.

Exercises

- Think about a marital relationship where you know the couple fairly well. Examining the three relational dimensions (conventional/nonconventional ideology, interdependence/autonomy, and conflict engagement/avoidance), how would you categorize this couple? Why?
- Access a copy of Mary Anne Fitzpatrick's Relational Dimensions Instrument (<https://www.researchgate.net/publication/232561704> The instrumental and expressive domains of marital communication), have a married couple that you know to complete the instrument separately. How similar were their responses? How different were their responses?
- Think about a marital relationship where you know the couple fairly well. Based on what you know about this couple, would you consider them traditional, independents, or separates? Why? Please be specific with your answer to

Chapter Wrap-Up

As we discussed at the beginning of this chapter, families are a central part of our lives. Thankfully, several communication scholars have devoted their careers to understanding families. In this chapter, we started by exploring the nature of family relationships with a specific focus on family communication patterns and family systems. Next, we explored the family life cycle. We then discussed the nature of sibling relationships. Lastly, we ended the chapter by discussing marriage.

End of Chapter

KEY TERMS

- Autonomy
- Concept-Oriented
- Family
- Genogram
- Ideology of traditionalism
- Independents
- Individuality
- Launching Stage
- Separates
- Sibling hostility
- Sibling warmth
- Socio-Oriented
- System
- Third-Culture
- Togetherness
- Traditionals
- Undifferentiated space

REAL WORLD CASE STUDY

demonstrate your understanding of these three marital types.

Nick and Diane were strangers flying on Continental flight 05 from London's Gatwick Airport to Houston, TX, when the terrorist attacks on 9-11 struck in the United States. Their plane, along with 38 other wide-body jets, was diverted to Gander International Airport in Newfoundland, Canada. Gander is a city of approximately 10,000 people. What the town lacked in size, the airport made up for in capacity.

Gander International Airport was at one point one of the busiest airports in the world because it was the refueling stop for all planes flying from the United States to Europe and from Europe to the United States. In fact, over the years, Gander played host to Winston Churchill, Frank Sinatra, President Ronald Reagan, Marilyn Monroe, Elvis Presley, and many others who had stop-overs at the airport. As airlines switched to planes with larger fuel capacities, the need for Gander as the refueling stop faded into a thing of the past.

On 9-11, 38 planes, along with 6,122 passengers and 473 flight crew members, suddenly joined the small community. As you can imagine, most cities are not prepared for a population growth of 66% in a matter of hours. Thankfully, the community members of Gander rallied and took care of those passengers and flight crew for four days in what was dubbed Operation Yellow Ribbon.

On the flight, Diane was in the front of the plane while Nick was at the back of the plane. The two had never met or even really laid eyes on each other. Both were taken to a place called Gambo, about 20 minutes outside of Gander. At the shelter there, the two met in line waiting to get blankets. One of them commented about how the blankets smelled, and the two just started talking. Nick, sensing the possibility of a new friend, ended up bunking next to Diane in the shelter. The two shared stories and trail mix. Over the next few days, the two started to fall in love.

One night, the two, along with other passengers, went to a local pub where the two became official Newfoundlanders, by drinking Screech and kissing a cod. During the midst of the festivities, a local justice of the peace made the mistake of assuming the two were a couple. When he found out they weren't, the justice said, "I can marry the two of you." To which Diane responded, "sure!" Admittedly, it was probably the Screech talking, but in that moment, Diane realized that she really was starting to like Nick and that she could see him romantically.

After four days, a hurricane was quickly approaching Newfoundland, so there was a short time period to get the planes off the ground once the U.S.'s airspace was reopened. On the bus heading back to the airport, Diane started to tear up, realizing that this side journey in life was ending. Nick leaned in to comfort her and kiss her on the forehead, but Diane took the opportunity to turn it into a more romantic experience.

Nick ultimately proposed to Diane over the phone in November, and the two were married on September 7, 2002, and they honeymooned in Newfoundland. Nick and Diane Marson are very much real people. You can even follow them on Twitter, @RealNickandDiane. Their story is actually one of the main plot-points in the awarding winning Broadway musical *Come From Away*, which explores the generosity of the people of Gander and the ones who come from away.

1. What do you think it was about this situation that drew the couple together?
1. How would you describe their relationship using the family life cycle?
2. Why do you think Nick and Diane Marson's story has been so captivating to millions of people around the world?

END OF CHAPTER QUIZ

1. Socio-orientation is characterized by all of the following except _____.
 - a. Harmony
 - b. Similarity of values
 - c. Relatively little communication
 - d. Self-expression
2. Concept-orientation is characterized by all of the following except _____.
 - a. Self-expression
 - b. Open communication between parent and child
 - c. Frequent communication between parent and child
 - d. Harmony
3. A _____ is a pictorial representation of a family across generations that can be used to track generations of family interactions, medical issues, psychological issues, relationship patterns, and any other variable a researcher or clinician may be interested in studying.
 - a. Family life cycle
 - b. Family system chart

- c. Genogram
 - d. Genealogy tree
4. In which stage of David Weaver and Laura Lawton's Family Life Cycle are adolescents "launched?"
- a. Full nest two
 - b. Full nest three
 - c. Empty nest one
 - d. Empty nest two
5. Which of Mary Anne Fitzpatrick's marital types is marked by being highly interdependent, having conventional ideology, and having high levels of conflict engagement.
- a. Traditionals
 - b. Independents
 - c. Separates
 - d. Temporals

References

- 1 Burgess, E. W. (1926). The family as a unity of interacting personalities. *The Family*, 7(1), 3-9. <https://doi.org/10.1177/104438942600700101>
- 2 Burgess, E. W. (1963). *The family: From institution to companionship* (3rd ed.). American Book Company; pg. 2.
- 3 Murdock, G. P. (1949). *Social structure*. Macmillan; pg. 141.
- 4 Malinowski, B. (1927). *Sex and reproduction in savage society*. Commentator.
- 5 Bailey, B. L. (1988). *From the front porch to back seat: Courtship in twentieth-century America*. Johns Hopkins University Press.
- 6 Mintz, S., & Kellog, S. (1988). *Domestic revolutions: A social history of American family life*. Free Press.
- 7 Otto, L.B. (1988). America's youth: A changing profile. *Family Relations*, 37(4), 385-391.
- 8 Bochner, A. P. (1975). *Family communication research: a critical review of approaches, methodologies and substantive findings* [Paper presentation]. Annual Meeting, Speech Communication Association, Chicago, IL, United States.
- 9 Bochner, A. P. (1988). Conceptual frontiers in the study of communication in families: An introduction to the literature. *Family Relations*, 37, 385-391; pg. 328.
- 10 Gerstel, N., & Gross, H. E. (1982). Commuter marriages: A review. *Marriage & Family Review*, 5(2), 71-93. https://doi.org/10.1300/J002v05n02_05; pg. 81.
- 11 Burgess, E. W. (1926). The family as a unity of interacting personalities. *The Family*, 7(1), 3-9. <https://doi.org/10.1177/104438942600700101>
- 12 Burgess, E. W. (1926). The family as a unity of interacting personalities. *The Family*, 7(1), 3-9. <https://doi.org/10.1177/104438942600700101>
- Murdock, G. P. (1949). *Social structure*. Macmillan; pg. 141.
- Bailey, B. L. (1988). *From the front porch to back seat: Courtship in twentieth-century America*. Johns Hopkins University Press.
- 13 Bavelas, J. B., & Segal, L. (1982). Family systems theory: Background and implication. *Journal of Communication*, 32(3), 99-107. <https://doi.org/10.1111/j.1460-2466.1982.tb02503.x>
- 14 McLeod, J. M., & Chaffee, S. H. (1972). The construction of social reality. In J.T. Tedeschi (Ed.), *The social influence processes* (pp. 50-99). Aldine-Atherton.
- 15 Ritchie, L. D., & Fitzpatrick, M. A. (1990). Family communication patterns: Measuring intrapersonal perceptions of interpersonal relationships. *Communication Research*, 17 (4), 523-544. <https://doi.org/10.1177/009365090017004007>
- 16 Ritchie, L. D. (1991). Family communication patterns: An epistemic analysis and conceptual reinterpretation. *Communication Research*, 18(4), 548-565. <https://doi.org/10.1177/009365091018004005>
- 17 McLeod, J. M., & Chaffee, S. H. (1972). The construction of social reality. In J.T. Tedeschi (Ed.), *The social influence processes* (pp. 50-99). Aldine-Atherton; pg. 83.
- 18 Ibid.; pg. 83.
- 19 Ibid.; pg. 86.
- 20 Ibid.; pg. 85.
- 21 Bogdanov, A. A. (1980). *Essays in tektology: The general science of organization* (G. Gorelik, Trans.). Intersystems Publications.
- 22 Bertalanffy, L. von (1934). *Modern theories of development* (J. H. Woodger, Trans.). Oxford University Press.
- Bertalanffy, L. von (1951). Problems of general systems theory. *Human Biology*, 23, 302-312.
- Bertalanffy, L. von (1955). General systems theory. *Main Currents in Modern Thought*, 11, 75-83.
- Bertalanffy, L. von (1968). *General systems theory*. George Braziller.
- 23 Bertalanffy, L. von (1968). *General systems theory*. George Braziller; pg. 38.
- 24 Bowen, M. (1978). *Family therapy in clinical practice*. Aronson.

- 25 Kerr, M. E., & Bowen, M. (1988). *Family evaluation: An approach based on Bowen theory*. Norton.
- 26 Regina, W. F. (2011). *Applying family systems theory to mediation: A practitioner's guide* [Adobe digital edition]. University Press of America; pg. 16.
- 27 Ibid.; pgs. 16-17.
- 28 Bowen, M. (2004). *Family therapy in clinical practice* (Updated ed.). Rowan & Littlefield; pg. 65.
- 29 Ibid; pg. 65.
- 30 Galvin, K. M., Dickson, F. C., & Marrow, S. R. (2006). Systems theory: Patterns and (w)holes in family communication. In D. P. Braithwaite and L. A. Baxter (Eds.), *Engaging theories in family communication: Multiple perspectives* (pp. 309-324). Sage.
- 31 Ibid.; pg. 313.
- 32 Kerr, M. E. (2019). *Bowen theory's secrets: Revealing the hidden life of families*. W. W. Norton.
- 33 Parent, J., McKee, L. G., N. Rough, J., & Forehand, R. (2016). The association of parent mindfulness with parenting and youth psychopathology across three developmental stages. *Journal of Abnormal Child Psychology*, 44(1), 191-202. <https://doi.org/10.1007/s10802-015-9978-x>
- 34 Suttie, J. (2016, June 13). How mindful parenting differs from just being mindful: According to new research, children who experience mindful parenting are less likely to use drugs or get depression or anxiety. *Mindful*. <https://www.mindful.org/mindful-parenting-may-keep-kids-trouble/>; para. 8.
- 35 Kabat-Zinn, M., & Kabat-Zinn, J. (1997). *Everyday blessings: The inner work of mindful parenting*. Hyperion.
- 36 McGoldrick, M., Gerson, R., & Shellenberger, S. (1999). *Genograms: Assessment and intervention* (2nd ed.). W. W. Norton.
- 37 Parent, J., Clifton, J., Forehand, R., Golub, A., Reid, M., & Pichler, E. R. (2014). Parental mindfulness and dyadic relationship quality in low-income cohabiting black stepfamilies: Associations with parenting experienced by adolescents. *Couple & Family Psychology*, 3(2), 67–82. <https://doi.org/10.1037/cfp0000020>; pg. 8.
- 38 Ibid.; pg. 12.
- 39 Loomis, C. P. (1936). The study of the life cycle of families. *Rural Sociology*, 1(2), 180-199.
- 40 Weaver, D., & Lawton, L. (2014). *Tourism management* (5th ed.) John Wiley & Sons.
- 41 Isidore, C. (2020, March 16). More than half of American jobs are at risk because of coronavirus. *CNN Business*. <https://www.cnn.com/2020/03/16/economy/job-losses-coronavirus/index.html>
- 42 Cohen, P., & Hsu, T. (2020, June 11). 'Rolling shock' as job losses mount even with reopenings: Nearly three million new unemployment claims brought the two-month total to more than 36 million, even with some still frustrated in seeking benefits. *The New York Times*. <https://tinyurl.com/ybh3pyzl>
- 43 Backer, E. (2012). Investigating the “family life cycle” model in tourism. In H. Schänzel, I. Yeoman, & E. Backer (Eds.), *Family tourism: Multidisciplinary perspectives* (pp. 156–170). Channel View Publications; pg. 167.
- 44 McGuire, S., McHale, S. M., & Updegraff, K. (1996). Children's perceptions of the sibling relationship in middle childhood: Connections within and between family relationships. *Personal Relationships*, 3(3), 229–239. <https://doi.org/10.1111/j.1475-6811.1996.tb00114.x>
- 45 Stocker, C., & McHale, S. (1992). The nature and family correlates of preadolescents' perceptions of their sibling relationships. *Journal of Social and Personal Relationships*, 9(2), 179–195. <https://doi.org/10.1177/0265407592092002>
- 46 Ibid.
- 47 Padilla-Walker, L. M., Harper, J. M., & Jensen, A. C. (2010). Self-regulation as a mediator between sibling relationship quality and early adolescents' positive and negative outcomes. *Journal of Family Psychology*, 24(4), 419-428. <https://doi.org/10.1037/a0020387>
- 48 Epkins, C. C., & Dedmon, A. M. M. (1999). An initial look at sibling reports on children's behavior: Comparisons with children's self-reports and relations with siblings' self-reports and sibling relationships. *Journal of Abnormal Child Psychology*, 27(5), 371-381. <https://doi.org/10.1023/A:1021975901564>
- 49 Sherman, A. M., Lansford, J. E., & Volling, B. L. (2006). Sibling relationships and best friendships in young adulthood: Warmth, conflict, and well-being. *Personal Relationships*, 13(2), 151–165. <https://doi.org/10.1111/j.1475-6811.1996.tb00114.x>

org/10.1111/j.1475-6811.2006.00110.x

50 Derkman, M. M. S. (2011). *Siblinks: The implications of siblings for adolescents' adjustment and parent-child relationships* (Unpublished doctoral dissertation). Radboud University, Nijmegen, Netherlands. Retrieved from: <http://repository.ubn.ru.nl/bitstream/2066/91240/1/91240.pdf>

51 Buist, K. L., & Vermande, M. (2014). Sibling relationship patterns and their associations with child competence and problem behavior. *Journal of Family Psychology*, 28, 529-537. <http://dx.doi.org/10.1037/a0036990>

52 Derkman, M. M. S. (2011). *Siblinks: The implications of siblings for adolescents' adjustment and parent-child relationships* [Unpublished doctoral dissertation]. Radboud University. Retrieved from: <http://repository.ubn.ru.nl/bitstream/2066/91240/1/91240.pdf>

53 Buist, K. L., & Vermande, M. (2014). Sibling relationship patterns and their associations with child competence and problem behavior. *Journal of Family Psychology*, 28(4), 529-537. <https://doi.org/10.1037/a0036990>

54 Ibid.; pg. 534.

55 Myers, S. A., Cavanaugh, E. K., Dohmen, L. M., Freeh, J. L., Huang, V. W., Kapler, M. R., Leonatti, A., Malicay, M. M., Schweig, V., Sorensen, H. J., Vang, M. M., & Wise, D. C. (1999). Perceived sibling use of relational communication messages and sibling satisfaction, liking, and loving. *Communication Research Reports*, 16(4), 339-352. <https://doi.org/10.1080/08824099909388735>

56 Myers, S. A., & Weber, K. D. (2004). Preliminary development of a measure of sibling relational maintenance behaviors: Scale development and initial findings. *Communication Quarterly*, 52(4), 334-346. <https://doi.org/10.1080/01463370409370204>

57 Ibid.

58 Fitzpatrick, M. A. (1988). *Between husbands and wives: Communication in marriage*. Sage. Retrieved from: https://www.researchgate.net/publication/232440676_Between_Husbands_Wives_Communication_in_Marriage_Sage_series_in_interpersonal_communication_Vol_7

59 Fitzpatrick, M. A. (1976). *A typological examination of communication in enduring relationships* [Unpublished Ph.D. Dissertation]. Temple University.

60 Fitzpatrick, M. A. (1977). A typological approach to communication in relationships. In B. Rubin (Ed.), *Communication yearbook I* (pp. 263-275). Transaction – International Communication Association.

61 Fitzpatrick, M. A., & Best, P. (1979). Dyadic adjustment in traditional, independent, and separate relationships. *Communication Monographs*, 46(3), 167-178. <https://doi.org/10.1080/03637757909376004>

62 Fitzpatrick, M. A., & Indvik, J. (1982). The instrumental and expressive domains of marital communication. *Human Communication Research*, 8(3), 195-213. <https://doi.org/10.1111/j.1468-2958.1982.tb00664.x>

Fitzpatrick, M. A. (1988). *Between husbands and wives: Communication in marriage*. Sage.

63 Fitzpatrick, M. A. (1977). A typological approach to communication in relationships. In B. Rubin (Ed.), *Communication yearbook I* (pp. 263-275). Transaction – International Communication Association; pg. 266.

64 Fitzpatrick, M. A. (1988). *Between husbands and wives: Communication in marriage*. Sage; pg. 73.

65 Ibid.; pg. 70.

66 Ibid..

67 Fitzpatrick, M. A. (1977). A typological approach to communication in relationships. In B. Rubin (Ed.), *Communication yearbook I* (pp. 263-275). Transaction – International Communication Association.

Fitzpatrick, M. A., & Best, P. (1979). Dyadic adjustment in traditional, independent, and separate relationships. *Communication Monographs*, 46(3), 167-178. <https://doi.org/10.1080/03637757909376004>

68 Noller, P., & Fitzpatrick, M. A. (1993). *Communication in family relationships*. Allyn & Bacon; pg. 185.

69 Fitzpatrick, M. A., Jandt, F. E., Myrick, F. L., & Edgar, T. (1994). Gay and lesbian couple relationships. In J. Ringer (Ed.), *Queer words, queer images: Communication and the construction of homosexuality* (pp. 265-277). New York University Press.

70 Ibid.; pg. 271.

- 71 Umberson, D., Thomeer, M. B., Kroeger, R. A., Lodge, A. C., & Xu, M. (2015). Challenges and opportunities for research on same-sex relationships. *Journal of Marriage & Family*, 77(1), 96–111. <https://doi.org/10.1111/jomf.12155>
- 72 Zrenchik, K., & Craft, S. M. (2016). The state of GLBT family research: An opportunity to critically

END OF CHAPTER QUIZ

ANSWER KEY

1) D 2) D 3) C 4) D 5) A



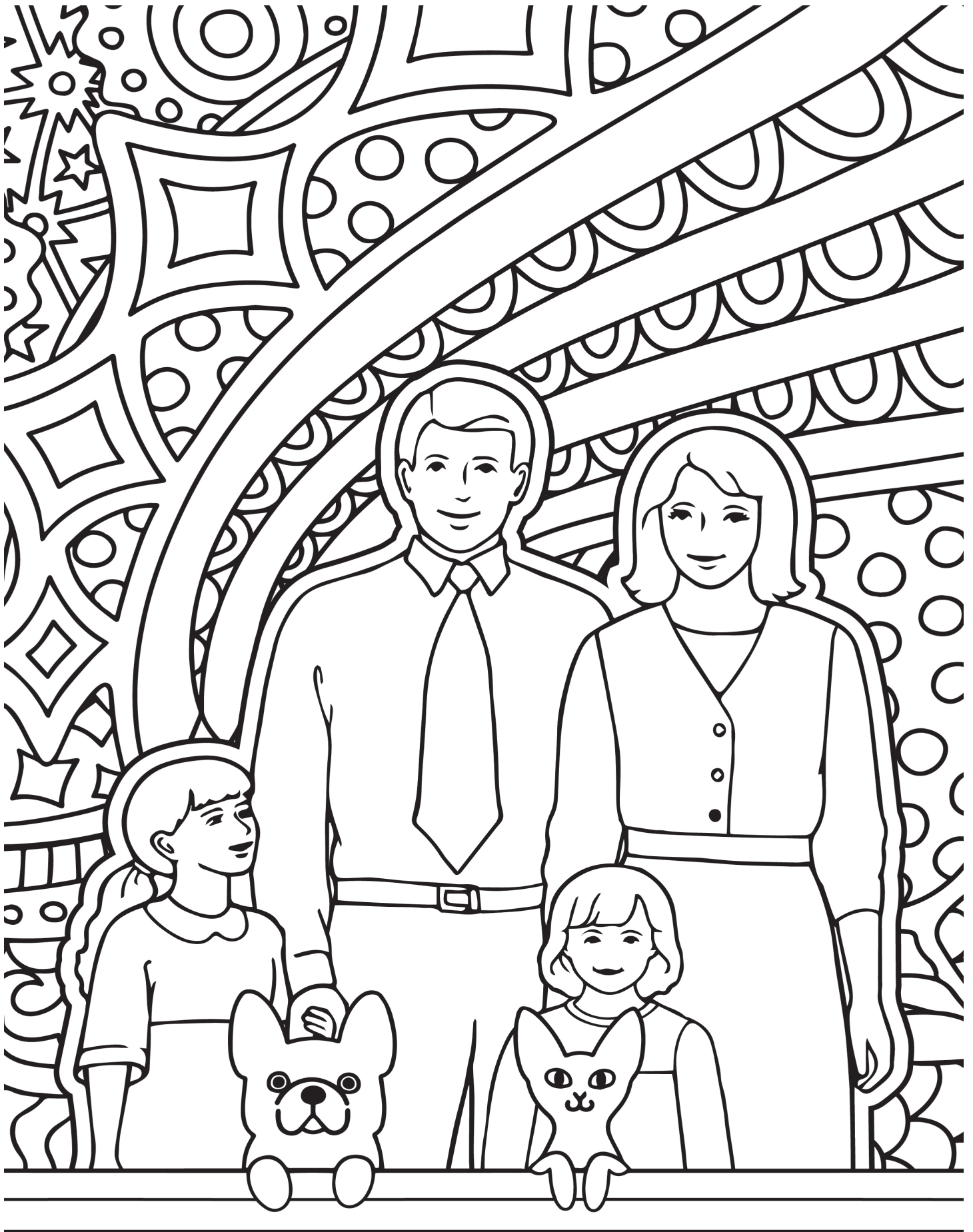



Image by [Alexandra Koch](#) from [Pixabay](#)

Chapter 12

Interpersonal Communication in Mediated Contexts

In today's world, we all spend a lot of time on various devices designed to make our lives easier. From smartphones to social media, we are all in constant contact with family, friends, coworkers, etc. Since the earliest days of communication technologies, we have always used these technologies to interact with one another. This chapter will examine how technology mediates our interpersonal relationships.

12.1 Technology and Communication

LEARNING OUTCOMES

1. Explain the history of computer-mediated communication.
2. Recognize some of the important figures in the creation of the Internet, the World Wide Web, and computer-mediated communication.

Since the Internet's creation in 1969, public access to the Internet and the creation of the World Wide Web (WWW) in 1991, and the proliferation of Internet Service Providers (ISPs) through the late 1990s, the technology that shapes your life today and will shape your life tomorrow is still relatively new. Here are some relatively recent landmarks in social media sites, technology, and apps: LinkedIn (2003), iTunes (2003), Facebook (2004), YouTube (2005), Twitter (2006), iPhone (2007), Drop Box (2008), Google Docs (2009), Kickstarter (2010), Google+ (2011), Google Glass (2012), Oculus Rift (2013), and iWatch (2014). As you can imagine, just limiting this list is hard. Some of these products you're probably very familiar with while others may be altogether new to you.



Figure 12.1a Abacus
“A Chinese Abacus.” by [Shieldforyoureyes](#). This file is licensed under the [Creative Commons Attribution 3.0 Unported](#) license.

So, our first question should be, what is a computer. In its earliest use, “computers” referred to people who performed massive numbers of calculations by hand or using a tool like an abacus (Figure 12.1a) or slide rule (Figure 12.1b). As you can imagine, this process wasn't exactly efficient and took a lot of human resources. The 2016 movie *Hidden Figures* relates the true story

From Math to Punch Cards

Before we get started, it's essential to understand the evolution of what we call computer-mediated communication or CMC. Although in recent years some scholars have adopted the broader term “communication and technology,” we don't think this is necessary, because a computer of some kind is always at the center of these communicative interactions.

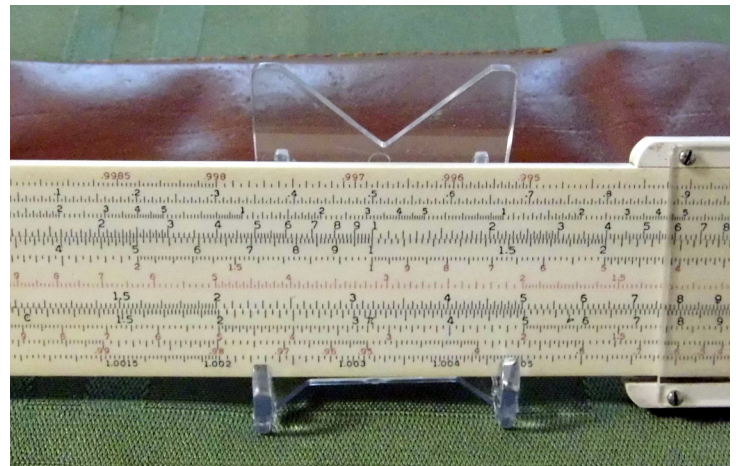

Figure 12.1c Slide Rule
“Vintage Compass Slide Rule.” by [Joe Haupt](#). This file is licensed under the [Creative Commons Attribution 2.0 Unported](#) license.



Figure 12.2 Jacquard Loom
“NMS Jacquard loom 2.JPG.” by Ad Meskens. This file is licensed under the [Creative Commons Attribution 3.0 Unported](#) license.

of a group of African American computers who created the calculations to land the first Astronaut on the Moon.¹

The first mechanical ancestor of the computer we have today was created in 1801 by a Frenchman named Joseph Marie Jacquard, who created a loom that used punched wooden cards to weave fabric (Figure 12.2). The idea of “punch cards” would be the basis of many generations of computers up to the 1960s. Of course, the punch cards went from being wood cards to cardboard or cardstock over the course of their history. Some of the earliest statistical research in the field of communication was conducted using punchcards. As you can imagine, between 1801 and the 1960s, many people worked to advance early computer technology. Many wonderful books can introduce you to the full history of how we came to the modern personal computer.²

The 1970s saw the start of the explosion of the personal computer (e.g., the release of the Apple II line in 1977). In 1981, IBM released the IBM PC, also known as the Acorn, which ran on Microsoft DOS, which was followed up by Apple’s Lisa in 1983, which had a graphic user interface. From that point until now, Microsoft and Apple (Macintosh) have cornered the market on personal computers.

Getting Computers to Interact

One thing that we have seen is that with each new computer development is new technologies emerging that have helped us communicate and interact. One significant development in 1969 changed the direction of human communication forever. Starting in 1965, researchers at the Massachusetts Institute of Technology were able to get two computers to “talk” to each other. Of course, it’s one thing to get two computers side-by-side to talk to each other, but could they get computers at a distance to talk to each other (in a manner similar to how people use telephones to communicate at a distance)?

Researchers at both UCLA and Stanford, with grant funding from the U.S. Department of Defense Advanced Research Projects Agency (ARPA), set out to get computers at a distance to talk to each other. In 1969, UCLA student Charley Kline attempted the first computer-to-computer communication over a distance from his terminal in Los Angeles to a terminal at Stanford using a computer network. Although it had been possible for remote computers to interact with one another, scientists had to have separate computers for each remote computer they were connecting with. The 1969 breakthrough, was the

creation of a system that could allow all computers to use a single network to interact.³ The first message to be sent was to be a simple one, “login.” The letter “l” was sent, then the letter “o,” and then the system crashed. So, the first message ever sent over what would become the Internet was “lo.” An hour later, Kline got the system up and running again, and the full word “login” was sent.

In the earliest years of the Internet, most people didn’t know it existed. The Internet was primarily a tool for the Department of Defense to allow researchers at multiple sites across the country to work on defense projects. It was called the Advanced Research Projects Agency Network (**ARPANET**). In 1973, the University College of London (England) and the Royal Radar Establishment (Norway) connected to ARPANET, and the term “Internet” was born. A year later, in 1974, a commercialized version of ARPANET called Telenet became the first Internet service provider (ISP).

Allowing People to Communicate

The early Internet was not exactly designed for your average user, so it took quite a bit of skill and “know how” to use the Internet and find information. Of course, while the Internet was developing, so was its capability for allowing people to communicate and interact with one another. In 1971, Ray Tomlinson was working on two programs that could be used over ARPANET: SNDMSG and READMAIL. From his lab at MIT, Tomlinson sent a message from one computer to another computer sitting right next to it, sending the message through ARPANET and creating the first electronic email. Tomlinson also forever changed our lives by introducing the “@” symbol as the separator the Internet uses when sending and receiving messages.

In addition to email, another breakthrough in computer-mediated communication was the development of Internet forums or **message/bulletin boards**, which are online discussion sites where people can hold conversations in the form of posted messages. Steve Walker created an early message board for ARPANET. The primary message list for professionals was MsgGroup. The number one message board that was not business related was SF-Lovers, a science fiction list. As you can see, from the earliest days of the Internet, people were using the Internet as a tool to communicate and interact with people who had similar interests.

One early realization about email and message boards was that people relied solely on text to interpret messages, which lacked nonverbal cues to aid in interpretation. On September 19, 1982, Scott Fahlman, a research professor of computer science at Carnegie Mellon, came up with an idea. You see, at Carnegie Mellon in the early 1980s (like most research universities at the time), they had their own bulletin board system (BBS), which discussed everything from campus politics to science fiction. As Fahlman noted,

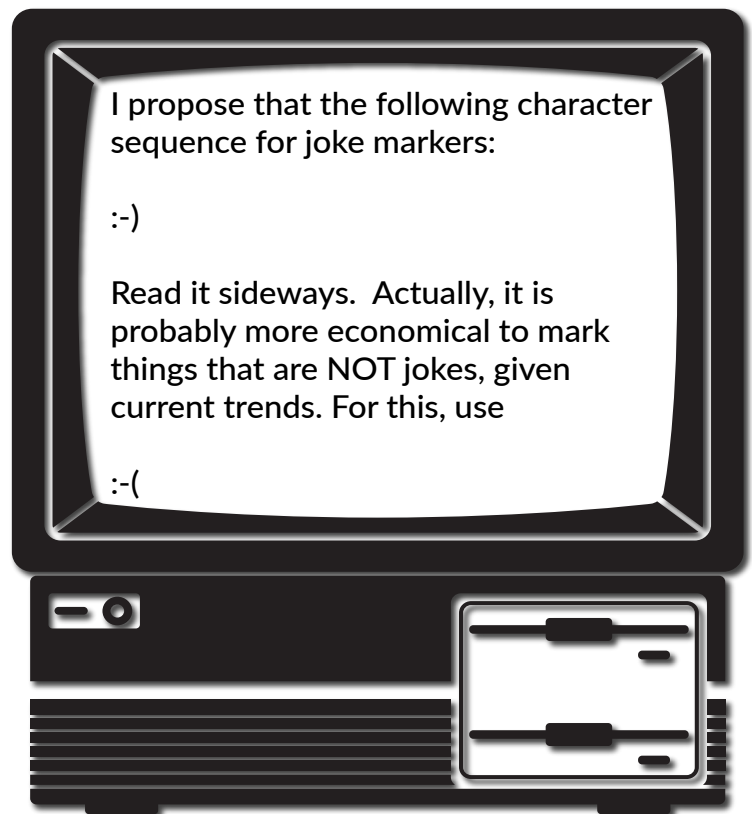

Figure 12.3 Emoticon Email

“Given the nature of the community, a good many of the posts were humorous, or at least attempted humor.” But “The problem was that if someone made a sarcastic remark, a few readers would fail to get the joke and each of them would post a lengthy diatribe in response.”⁴ After giving some thought to the problem, he posted the message seen in Figure 12.3. Thus, the **emoticon** (emotion icon) was born. An emoticon is a series of characters which is designed to help readers interpret a writer’s intended tone or the feelings the writer intended to convey. Over the years, many different emoticons were created like the smiley and sad faces, lol (laughing out loud), ROFL (rolling on the floor laughing), :-O (surprise), :-* (kiss), :-P (sticking your tongue out), :-/ (quizzical), :-X (sealed lips), 0:-) (angel), *\0/* (cheerleader), and so many others. As we’ve discussed previously in this text, so much of how we understand each other is based on our nonverbal behaviors, so these emoticons were an attempt to bring a lost part of the human communicative experience to a text-based communicative experience.

Asynchronous Communication

Some technologies are what we call **asynchronous**, a mediated form of communication in which the sender and receiver are not concurrently engaged in communication. When Person A sends a message, Person B does not need to be on the computer at the same time to receive the message. There could be a delay of hours or even days before that message is received and Person B responds. In this case, asynchronous messages are akin to letter writing.

We still engage in a wide range of asynchronous CMC. Some common forms of asynchronous communication today include email, texting, social media posts, and classroom discussion boards. Think about your own CMC behavior. What asynchronous methods for CMC do you engage in daily?

Synchronous Communication

Let’s switch gears for a bit and talk about the history of **synchronous** communication on the Internet. As the Internet grew and speed and infrastructure became more established, synchronous CMC was developed, a mediated form of communication in which the sender and receiver are concurrently engaged in communication. When Person A sends a message, Person B is receiving that message in real time, like they would in a face-to-face (FtF) interaction.

The first synchronous mode of communication was the chatroom. In 1988, Jarkko “WiZ” Oikarinen wrote the code for the first Internet Relay Chat (IRC) client and server at the University of Oulu, Finland. IRC was initially started as a system to replace an existing BBS, but WiZ realized that he had something completely different. With IRC, individuals from around the world could login using an IRC Chat Client (software on their computer), which would allow them to access a server elsewhere in the world to interact with people in real time

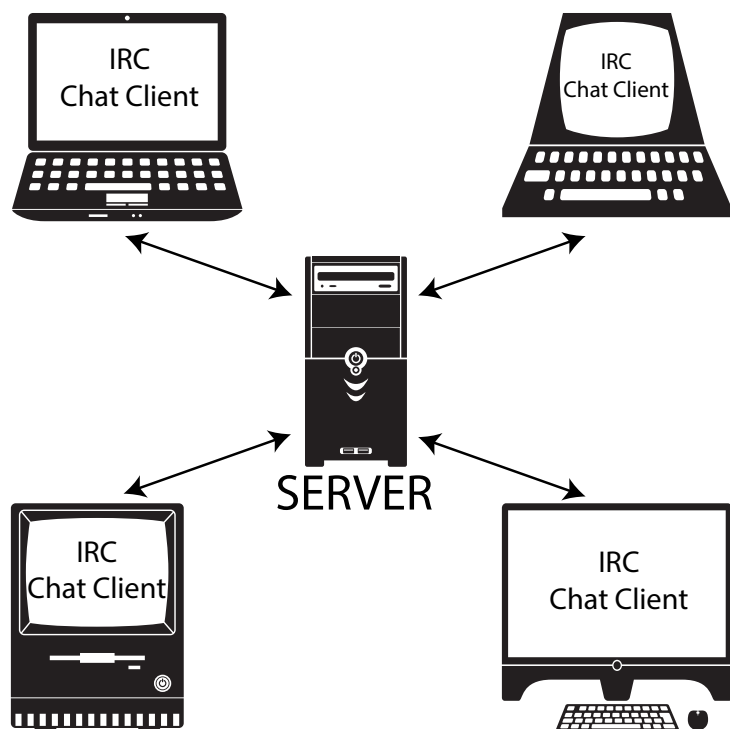

Figure 12.4 Internet Relay Chat

(Figure 12.4). The invention of IRC led to the proliferation of chatrooms throughout the 1980s and 90s.

New technology was also developed through the European organization Groupe Speciale Mobile (GSM). The goal of the GSM was to create protocols for second-generation global cellphone networks. One of the protocols that was created was the **Short Messaging Service (SMS)**. The concept was developed in 1985 by Friedhelm Hillebrand and Bernard Ghillebaert, but the first SMS message wouldn't be sent until 1992. SMS originated from the radio telegraphy in radio memo pagers using standardized phone protocols, and was later defined as part of the Global System for Mobile Communications series of standards in 1985. The “short” part of SMS refers to the maximum length of the messages that could be sent at the time: 160 characters (letters, numbers, or symbols in the Latin alphabet). If you haven't figured it out yet, the system created by Hillebrand and Ghillebaert is the system most of you use every day to send text messages. Although texting can be either asynchronous or synchronous, historically it was one of the earliest technologies to facilitate real-time (synchronous) online communication.

The World Wide Web

Our last major invention that indeed was groundbreaking came about in 1990. Tim Berners-Lee, a scientist working for Conseil Européen pour la Recherche Nucléaire (CERN), had an idea to help capture information from the people who worked at CERN. The typical length of time someone spent conducting research at CERN was only two years, so that meant a lot of new people coming and going without a way to capture what was being done. As Berners-Lee noted, “The actual observed working structure of the organisation is a multiply connected ‘Web’ whose interconnections evolve with time.”⁵ Furthermore, “The technical details of past projects are sometimes lost forever, or only recovered after a detective investigation in an emergency. Often, the information has been recorded, it just cannot be found.”⁶ You see, Berners-Lee realized that so much information is learned on the job and then leaves with the people as they leave the job. Berners-Lee proposed a new system for keeping electronic information. After getting some initial positive feedback, Berners-Lee and Robert Cailliau wrote a management report explaining hypertext:

HyperText is a way to link and access information of various kinds as a Web of nodes in which the user can browse at will. It provides a single user interface to large classes of information (reports, notes, data-bases, computer documentation and on line help). We propose a simple scheme incorporating servers already available at CERN...

A program which provides access to the hypertext world we call a browser...⁷

CERN was not really concerned with the Internet as its primary scope and emphasis, so CERN and Berners-Lee agreed to release the source code for the World Wide Web (WWW) to the world in April 1993. In 1994, Berners-Lee left CERN and took a job at MIT where he created the International World Wide Web Consortium (W3C) to develop common standards for communication on the WWW. W3C still exists today, and the WWW celebrated its 30th birthday on March 10, 2019. The 5th variation of the hypertext markup language (HTML) created by the W3C is currently in use. You're probably using HTML5 daily and don't even realize it. As the W3C notes, “HTML5 contains powerful capabilities for Web-based applications with more powerful interaction, video support, graphics, more styling effects, and a full set of APIs. HTML5 adapts to any device, whether desktop, mobile, tablet, or television.”⁸

Key Takeaways

- Starting with the invention of the Internet in 1969, computer-mediated

communication has evolved over the years as technology has advanced.

- Many important figures have helped create computer-mediated communication as we know it today. Some of the key players include Ray Tomlinson (inventor of email), Scott Fahlman (creator of emoticons/emojis), Jarkko “WiZ” Oikarinen (inventor of chatrooms), Friedhelm Hillebrand and Bernard Gillebaert (creators of text messaging), and Tim Berners-Lee (inventor of the World Wide Web). These are just a handful of the many women and men who had a part in the development of computer-mediated communication.

Exercises

- When you look back at your own life, which computer-mediated technologies do you remember interacting with? Think back to your earliest experiences with CMC. How has your own CMC behavior and use of technology evolved over time.
- Check out the World Wide Web Consortium’s (W3C) website (<https://www.w3.org/>) and see what projects they’re working on today. Why is the W3C still relevant today?

12.2 The CMC Process

LEARNING OUTCOMES

1. Differentiate between synchronous and asynchronous communication.
2. Explain the role of nonverbal cues in computer-mediated communication.
3. Describe the various rules and norms associated with computer-mediated communication and their importance to netiquette.
4. Examine the human communication factors related to computer-mediated communication.
5. Discuss the process and importance of forming impressions online.

As interpersonal communication scholars, our interest in CMC is less about the technologies that people are using and more about how people are using technology to interact with one another. So instead of focusing on how one goes about coding new software, interpersonal communication scholars focus on how new technologies and software help facilitate interpersonal communication. For example, Pat and Sam are playing the latest Massive Multiplayer Online Roleplaying Game (e.g., Word of Warcraft, Fortnite). In Figure 12.5 we have two people playing a video game over the together but from different locations. Through a technology called VoIP, Sam and Pat can play video games at the same time while talking to each other through the use of headsets.

Synchronous and Asynchronous Communication

In this section, we're going to delve more deeply into the areas of synchronous and asynchronous communication. In Figure 12.5, Sam and Pat are in some kind of underworld, fiery landscape. Pat is playing a witch character, and Sam is playing a vampire character.

The two can coordinate their movements to accomplish in-game tasks because they can talk freely to one another while playing the game in real time. As previously discussed, this type of CMC is synchronous communication, or communication that happens in real time. Conversely, asynchronous communication is the exchange of messages with a time lag. In other words, in asynchronous communication, people can communicate on their own schedules as time permits instead of in real time. For example, Figure 12.6 shows a conversation between two college students. In this case, two college students are using SMS, commonly called texting) to interact with each other. The conversation starts at 2:25 PM. The first person initiates the conversation, but doesn't get a response until 3:05 PM. The third turn in the interaction then doesn't happen until 5:40 PM. In this exchange, the two people interacting can send responses at their convenience, which is one of the main reasons people often rely on asynchronous communication. Other common forms of asynchronous communication include emails, instant messaging, online discussions, etc....

Now, is it possible for people to use the same SMS technology to interact synchronously? Of course. One of our coauthors remembers two students on a trip who were sitting next to each other and texting back-and-forth because they didn't want their conversation to be overheard by others in the van. Their interaction was clearly mediated, and in real time, so it would be considered synchronous communication.

Nonverbal Cues

One issue related to CMC is nonverbal communication. Historically, most of the media people have used to interact with one another have been asynchronous and text-based, making it difficult to fully ascertain the



Figure 12.5 Video Game Play



Figure 12.6 Asynchronous Communication via SMS (Text Messaging)

meaning behind a string of words. Mary J. Culnan and M. Lynne Markus believe that the functions nonverbal behaviors meet in interpersonal interactions simply go unmet in CMC.⁹ If so, interpersonal communication must always be inherently impersonal when it's conducted using computer-mediated technologies. This perspective has three underlying assumptions:

1. Communication mediated by technology filters out communicative cues found in FtF interaction,
2. Different media filter out or transmit different cues, and
3. Substituting technology-mediated for FtF communication will result in predictable changes in intrapersonal and interpersonal variables.¹⁰

Let's breakdown these assumptions. First, CMC interactions "filter out" communicative cues found in FtF interactions. For example, if you're on the telephone with someone, you can't make eye contact or see their gestures, facial expressions, etc.... If you're reading an email, you have no nonverbal information to help you interpret the message because there is none. In these examples, the nonverbal cues have been "filtered out" by the media being used. We will revisit this information later in this chapter when we look at a range of theories related to CMC.

Unfortunately, even if we don't have the nonverbals to help us interpret a message, we interpret the message using our perception of how the sender intended us to understand this message, which is often wrong. How many times have you seen an incorrectly read text or email start a conflict? Of course, one of the first attempts to recover some sense of nonverbal meaning was the emoticon that we discussed earlier in this chapter.

CMC Rules and Norms

As with any type of communication, some rules and norms govern how people communicate with one another. For example, Twitter has an extensive Terms of Service policy that covers a wide range of communication rules. For our purposes here, let's examine their rules related to hate speech:

Hateful conduct: You may not promote violence against or directly attack or threaten other people on the basis of race, ethnicity, national origin, sexual orientation, gender, gender identity, religious affiliation, age, disability, or serious disease. We also do not allow accounts whose primary purpose is inciting harm towards others on the basis of these categories.

Hateful imagery and display names: You may not use hateful images or symbols in your profile image or profile header. You also may not use your username, display name, or profile bio to engage in abusive behavior, such as targeted harassment or expressing hate towards a person, group, or protected category.¹¹

This statement is an obvious example of a rule that exists on the Twitter platform. Of course, some have argued that these rules are pretty flexible at times, given the type of hateful political speech that is often Tweeted by different political figures.

In addition to clearly spelled out rules that govern how people communicate via different technologies, there are also norms. A norm, in this context, is an accepted standard for how one communicates and interacts with others in the CMC environment. For example, one norm by **TYPING IN ALL CAPITAL LETTERS**, which is considered yelling, people can get frustrated. There's actually not a consensus on when the use of all caps as a form of yelling first came to be. We do know that

newspapers in the 1880s often used all capital letters to emphasize headlines (basically have them jump off the page). At some point in the early 1980s, using all caps as a form of yelling became quite the norm, which was noted in a message post by Dave Decot in 1984 (Figure 12. 7).¹²

In this example, you see three different attempts to create possible systems for emphasizing words. The first is the use of all capital letters for making words seem “louder,” which, as already mentioned, eventually became known as yelling.

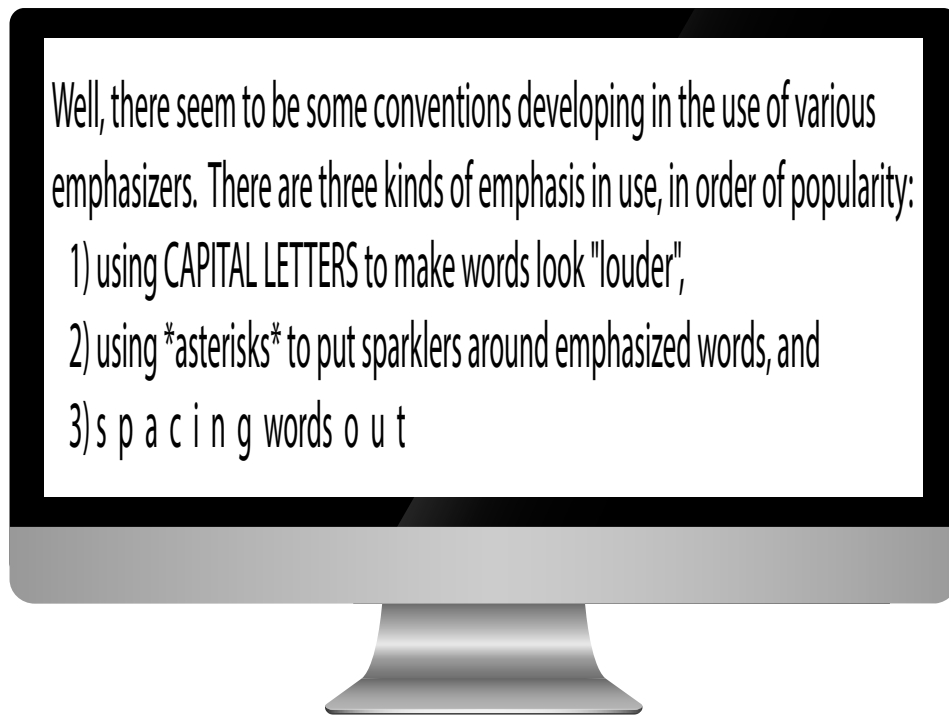

Figure 12.7 The Creation of YELLING

Netiquette

Over the years, numerous norms have developed to help individuals communicate in the CMC context. They're so common that we have a term for them, netiquette. **Netiquette** is the set of professional and social rules and norms that are considered acceptable and polite when interacting with another person(s) through mediating technologies. Let's breakdown this definition.

Research Spotlight



In a 2019 study conducted by Jale Ataşalar and Aikaterini Michou, the researchers set out to examine how mindfulness related to problematic Internet use (i.e., Internet addiction). This study was conducted in Ankara, Turkey, and examined 165 Turkish early adolescents (mean age was 13).

To measure mindfulness, the researchers revised the Mindful Attention Awareness

Scale created by Kirk Brown and Richard Ryan.¹³ The revised scale was used to measure the degree to which individuals engaged in mindful behaviors while online.

Overall, the researchers found that people who were mindful online were less likely to report engaging in problematic Internet use.

Ataşalar, J., & Michou, A. (2019). Coping and mindfulness: Mediators between need satisfaction and generalized problematic Internet use. *Journal of Media Psychology, 31*(2), 110–115. <https://doi.org/10.1027/1864-1105/a000230>

Contexts

First, our definition of netiquette emphasizes that different contexts can create different netiquette needs. Specifically, how one communicates professionally and how one communicates socially are often quite different. For example, you may find it entirely appropriate to say, “What’s up?!” at the beginning of an email to a friend, but you would not find it appropriate to start an email to your boss in this same fashion. Furthermore, it may be entirely appropriate to downplay or disregard spelling errors or grammatical problems in a text you send to a friend, but it is completely inappropriate to have those same errors and problems in a text sent to a professional-client or coworker. One of the biggest challenges many employers have with young employees who are fresh out of college is that they don’t know how to differentiate between appropriate and inappropriate communicative behavior in differing contexts.

This lack of professionalism is also a problem commonly discussed by college and university faculty and staff. Think about the last email you sent to one of your professors? Was this email professional? Did you remember to sign your name? You’d be amazed at the lack of professionalism many college and university faculty and staff see in the emails sent by your peers. Here are some general guidelines for sending professional emails:

- Include a concise, direct subject line.
- Do not mark something as “urgent” unless it really is.
- Begin with a proper greeting (Dear Mr. X, Professor Y:, etc.)
- Double-check your grammar.
- Correct any spelling mistakes.
- Include only essential information. Be concise.
- State your intention clearly and directly.
- Make sure your message is logically organized.
- Be polite and ensure your tone is appropriate.
- Avoid all CAPS or all lowercase letters.
- Avoid “textspeak” (e.g., plz, lol)
- If you want the recipient to do something, make the desired action very clear.
- End with a polite closing (using “please” and “thank you”).
- Do not send an email if you’re angry or upset.
- Edit and proofread before hitting “send.”
- Use “Reply All” selectively (very selectively)

Rules and Norms

Second, our definition of netiquette combines both rules and norms. Part of being a competent communicator in a CMC environment is knowing what the rules are and respecting them. For example, if you know that Twitter’s rules ban hate speech, then engaging in hate speech using the Twitter platform shows a disregard for the rules and would not be considered appropriate behavior. In essence, hate speech is anti-netiquette. We also do not want to ignore the fact that in different CMC contexts, different norms often develop. For example, maybe you’re taking an online course and you’re required to engage in weekly discussions. One common norm in an online class is to check the previously replies to a post before posting your reply. If you don’t, then you are jumping into a conversation that’s already occurred and throwing your two-cents in without knowing what’s happening.

Acceptable and Polite CMC Behavior

Third, netiquette attempts to govern what is both acceptable and polite. Yelling via a text message may be acceptable to some of your friends, but is it polite given that typing in all caps is generally seen as yelling? Being polite shows others respect and demonstrates socially appropriate behaviors.

MINDFULNESS ACTIVITY



If you've spent any time online recently, you may have noticed that it can definitely feel like a cesspool. There are many trolls, making the Internet a place where civil interactions are hard to come by. Mitch Ablett came up with five specific guidelines for interacting with others online:

1. Be kind and compassionately courteous with all posts and comments.
2. No hate speech, bullying, derogatory or biased comments regarding self, others in the community, or others in general.
3. No Promotions or Spam.
4. Do not give mental health advice.
5. Respect everyone's privacy and be thoughtful in the nature and depth of your sharing.¹⁴

Think about your interactions with others in the online world. Have you ever communicated with others without considering whether your own intentions and attitude are appropriate?

Online Interaction

Fourth, our definition involves interacting with others. This interaction can be one-on-one, or this interaction can be one-to-many. The first category, one-on-one, is more in the wheelhouse of interpersonal communication. Examples include sending a text to one person, sending an email to one person, talking to one person via Skype or Zoom, etc. The second category, one-to-many, requires its own set of rules and norms. Some examples of common one-to-many CMC could include engaging in a group chat via texting, "replying all" to an email received, being interviewed by a committee via Skype, etc. Notice that our examples for one-to-many involve the same technologies used for one-on-one communication. =

Range of Mediating Technologies

Lastly, netiquette can vary based on the different types of mediating technologies. For example, it may be considered entirely appropriate for you to scream, yell, and curse when your playing with your best friend on Fortnite, but it wouldn't be appropriate to use the same communicative behaviors when engaging in a video conference over Skype. Both technologies use VoIP, but the platforms and the contexts are very different, so they call for different types of communicative behaviors. Some differences will exist in netiquette based on whether you're in an entirely text-based medium (e.g., email, texting) or one where people can see you (e.g., Skype, WebEx, Zoom). Ultimately, engaging in netiquette requires you to learn what is considered acceptable and polite behavior across a range of different technologies.

Communication Factors

Communication factors are an essential part of understanding how computer-mediated communication

impacts interpersonal relationships. In this section, we're going to examine two specific communication factors that have been researched in a variety of CMC contexts: communication apprehension and impression formation.

Communication Apprehension

Most of the research examining CA and CMC started at the beginning of the 21st Century. Until 1996 when America Online (AOL) provided unlimited access to the Internet for a low monthly fee, most people did not have access to the Internet because of the cost. It wasn't until the public became more actively involved in interacting through technology that communication scholars became interested in communication traits related to CMC. One early study conducted by Scott W. Campbell and Michael R. Neer investigated whether an individual's level of communication apprehension (CA) could predict how they felt about CMC.¹⁵ In the study, the authors predicted that an individual's level of CA could predict whether the individuals believed that CMC was an effective medium for interpersonal communication; however, the researchers did not find a significant relationship. Furthermore, the researchers found that there wasn't a significant relationship between CA and people's satisfaction with their CMC experiences. Here's how the researchers attempted to make sense of these findings:

One plausible interpretation is that high apprehensives simply do not view CMC positively or negatively. Yet, they recognize that it reduces the threat posed to them in FtF settings. An equally plausible explanation is that high apprehensives do not regard CMC as an interpersonal obstacle to overcome because it is not FtF, but a substitute that fails to challenge or override their apprehension level.¹⁶

Jason S. Wrench and Narissra M. Punyanunt-Carter furthered the inquiry into CA and CMC by exploring how people reacted to different types of CMC. Specifically, Wrench and Punyanunt-Carter were interested in examining email CA, online chatting CA, and instant messaging CA. You can see the measures that Wrench and Punyanunt-Carter created for this study in Table 12.1. It's important to emphasize that the technologies listed in Table 12.1 here were the technologies most commonly used by the public when this study was conducted in the mid-2000s.

In addition to CMCA, Wrench and Punyanunt-Carter were also interested in an individual's skill levels with CMC. CMC skill was defined as three distinct concepts: computer efficacy (individuals' confidence in using a computer), Internet efficacy (individuals' confidence in using the Internet), and CMC competence. Brian H. Spitzberg believed that CMC competence consisted of three important factors: 1) people must be motivated to interact with others competently, 2) people must possess specialized knowledge and technical know-how, and 3) people must learn the rules and norms for communicating in the CMC context.¹⁷ Wrench and Punyanunt-Carter found that CMCA was negatively related to computer efficacy, Internet efficacy, and CMC competence.

In a subsequent study by Daniel Hunt, David Atkin, and Archana Krishnan, the researchers set out to examine CMCA and Facebook interactions, using a revised version of the Wrench and Punyanunt-Carter CMCA scales to measure Facebook CA.¹⁸ The study showed that CMCA decreased one's motivation to use Facebook as a tool for interpersonal communication. These findings were similar to those of Narissra M. Punyanunt-Carter, J. J. De La Cruz, and Jason S. Wrench, who examined CMCA on the social media app Snapchat.¹⁹ In this study, the researchers examined CMCA with regards to satisfying a combination of both functional and entertainment needs. Functional needs were defined as needs that drive an individual to accomplish something (e.g., feel less lonely, solve a problem, meet new people, decision making). Entertainment needs were defined as needs that allow an individual to keep

Instructions: This set of questions asks you about how you feel while communicating using email. If you have never used email, please leave this section blank. Work quickly and indicate your first impression. Please indicate the degree to which each statement applies to you by marking whether you:

Strongly Disagree 1	Disagree 2	Neutral 3	Agree 4	Strongly Agree 5
-------------------------------	----------------------	---------------------	-------------------	----------------------------

1. When communicating using email, I feel tense.
2. When communicating using email, I feel calm.
3. When communicating using email, I feel jittery.
4. When communicating using email, I feel nervous.
5. When communicating using email, I feel relaxed.

Instructions: This set of questions asks you about how you feel while communicating in online chat rooms, IRCs, or MUDDS. If you have never used chat rooms, IRCs, or MUDDS, please leave this section blank. Work quickly and indicate your first impression. Please indicate the degree to which each statement applies to you by marking whether you:

Strongly Disagree 1	Disagree 2	Neutral 3	Agree 4	Strongly Agree 5
-------------------------------	----------------------	---------------------	-------------------	----------------------------

1. When communicating in a chat room, IRC, or MUDD, I feel tense.
2. When communicating in a chat room, IRC, or MUDD, I feel calm.
3. When communicating in a chat room, IRC, or MUDD, I feel jittery.
4. When communicating in a chat room, IRC, or MUDD, I feel nervous.
5. When communicating in a chat room, IRC, or MUDD, I feel relaxed.

Instructions: This set of questions asks you about how you feel while communicating using Internet Messaging Programs like AOL Instant Messenger, Yahoo Messenger, or MSN Messenger. If you have never used Internet Messaging Programs, please leave this section blank. Work quickly and indicate your first impression. Please indicate the degree to which each statement applies to you by marking whether you:

Strongly Disagree 1	Disagree 2	Neutral 3	Agree 4	Strongly Agree 5
-------------------------------	----------------------	---------------------	-------------------	----------------------------

1. When communicating using an Internet messaging program, I feel tense.
2. When communicating using an Internet messaging program, I feel calm.
3. When communicating using an Internet messaging program, I feel jittery.
4. When communicating using an Internet messaging program, I feel nervous.
5. When communicating using an Internet messaging program, I feel relaxed.

Scoring

Email Apprehension

A: Add scores for items 1, 3, and 4 and place total on line. _____

B: Add scores for items 2 and 5 and place total on line. _____

Take the total from A and add 12 to the score. Place the new number on the line. _____

Final Score: Now subtract B from C. Place your final score on the line. _____

Chatting Apprehension

A: Add scores for items 6, 8, 9, 10 and place total on line. _____

B: Add scores for items 7 and 10 and place total on line. _____

Take the total from A and add 12 to the score. Place the new number on the line. _____

Final Score: Now subtract B from C. Place your final score on the line. _____

Instant Messaging Apprehension

A: Add scores for items 11, 13, and 14 and place total on line. _____

B: Add scores for items 12 and 15 and place total on line. _____

Take the total from A and add 12 to the score. Place the new number on the line. _____

Final Score: Now subtract B from C. Place your final score on the line. _____

Interpretation

Scores on all three measures should be between 5 and 25. For email apprehension, scores under 9.5 are considered low and scores over 9.5 are considered high. For chatting apprehension, scores under 11.5 are considered low and scores over 11.5 are considered high. For instant messaging apprehension, scores under 9 are considered low and scores over 9 are considered high.

Reference

Wrench, J. S., & Punyanunt-Carter, N. M. (2007). The relationship between computer-mediated-communication competence, apprehension, self-efficacy, perceived confidence, and social presence. *Southern Journal of Communication*, 72(4), 355-378. <https://doi.org/10.1080/10417940701667696>

Table 12.1 Computer-Mediated Communication Apprehension (CMCA)

Reprinted with permission of the authors here.

her/him/themselves occupied (e.g., because it's fun, because it's convenient, communicate easily). In this study, Punyanunt-Carter, De La Cruz, and Wrench found that individuals with high levels of Snapchat CA were more likely to use Snapchat for functional purposes than for entertainment purposes.

In a second study conducted by Punyanunt-Carter, De La Cruz, and Wrench, the researchers set out to examine social media CA in relation to introversion, social media use, and social media addiction.²⁰ In this study, the researchers found that social media CA was positively related to introversion, which is in line with previous research examining CA and introversion. Furthermore, introversion was negatively related to social media use, but social media CA was not related to social media use. Lastly, both social media CA and introversion were negatively related to social media addiction. Overall, this shows that individuals with social media CA are just not as likely to use social media, so they're less likely to become addicted to it.

So, what does all of this tell us? From our analysis of CA and CMC, we've come to understand that people with high levels of CA tend to function better in a CMC environment than in a FtF one, they're still less likely to engage in CMC as compared to those people with low levels of CMCA. People with low levels of CMCA just see CMC as another platform for communication.

Online Impression Formation

In the 21st Century, so much of what we do involves interacting with people online. How we present ourselves to others through our online persona (**impression formation**) is very important. How we communicate via social media and how professional our online persona is can be a determining factor in getting a job.

It's important to understand that in today's world, anything you put online can be found by someone else. According to the 2018 CareerBuilder.com social recruiting survey, a survey of more than 1,000 hiring managers, 70% admit to screening potential employees using social media, and 66% use search engines to look up potential employees.²¹ In fact, having an online persona can be very beneficial. Forty-seven percent of hiring managers admit to not calling a potential employee when the employee does not have an online presence. You may be wondering what employers are looking for when they check out potential employees online. The main things employers look for are information to support someone's qualifications (58%), whether or not an individual has a professional online persona (50%), to see what others say about the potential candidate (34%), and information that could lead a hiring manager to decide not to hire someone (22%).²² According to CareerBuilder.com, here are the common reasons someone doesn't get a job because of her/his/their online presence:

- Job candidate posted provocative or inappropriate photographs, videos or information: 40 percent
- Job candidate posted information about their alcohol or drug use: 36 percent
- Job candidate made discriminatory comments related to race, gender, religion, etc.: 31 percent
- Job candidate was linked to criminal behavior: 30 percent
- Job candidate lied about qualifications: 27 percent
- Job candidate had poor communication skills: 27 percent
- Job candidate bad-mouthed their previous company or fellow employee: 25 percent
- Job candidate's screen name was unprofessional: 22 percent
- Job candidate shared confidential information from previous employers: 20 percent
- Job candidate lied about an absence: 16 percent
- Job candidate posted too frequently: 12 percent²³

As you can see, many organizations believe that what you put online says a lot about you as a person, so they are checking the Internet for information. If what you have online is inappropriate, it may prevent you from getting hired, but fortunately, what you have online can also help get you hired. The same CareerBuilder.com study found that 57% of hiring managers have found information about a candidate online that has solidified their decision to hire that person. Here is a list of what hiring managers found that made them want to hire someone:

- Job candidate's background information supported their professional qualifications for the job: 37 percent
- Job candidate was creative: 34 percent
- Job candidate's site conveyed a professional image: 33 percent
- Job candidate was well-rounded, showed a wide range of interests: 31 percent
- Got a good feel for the job candidate's personality, could see a good fit within the company culture: 31 percent
- Job candidate had great communications skills: 28 percent
- Job candidate received awards and accolades: 26 percent
- Other people posted great references about the job candidate: 23 percent
- Job candidate had interacted with company's social media accounts: 22 percent
- Job candidate posted compelling video or other content: 21 percent
- Job candidate had a large number of followers or subscribers: 18 percent ²⁴

As you can see, having an online presence is important in the 21st Century. Some people make the mistake of having no social media presence, which can backfire. In today's social media society, having no online presence can look very strange to hiring managers. You should consider your social media presence as an extension of your resume. At the very least, you should have a profile on LinkedIn, the social networking site most commonly used by corporate recruiters. ²⁵

Research Spotlight



Mikaela Pitcan, Alice E. Marwick, and Danah Boyd set out to explore how young people of low socioeconomic status handled issues of privacy and presentation in social media. The researchers interviewed 28 young adults who considered themselves to be upwardly mobile. The researchers found two general themes through their interviews: respectability tactics and judgments of female sexuality.

First, the researchers found that the participants “self-censored in a manner they described as presenting a ‘neutral’ or ‘vanilla’ face, catering to the respectability norms of the most powerful potential viewers—often potential employers or high-status community members—rather than peers.”²⁶ The participants realized that having a social media presence was important, but they also knew that others could judge their social media use, so they were cognitively aware of what they posted. Furthermore, the participants were cognizant that their social media use today could be read by others in the future, so they had to consider a long-term perspective when it came to appropriateness online.

Second, there was a pattern of judging females' use of social media in sexually explicit ways. When it came to respectably presenting one's self online, women were judged more harshly for their inclusion of sexually

themed posts.

Pitcan, M., Marwick, A. E., & Boyd, D. (2018). Performing a vanilla self: Respectability politics, social class, and the digital world. *Journal of Computer-Mediated Communication*, 23(3), 163-179. <https://doi.org/10.1093/jcmc/zmy008>

Co-Present Interactions and Mediated Communication

For this discussion, we need to focus on the idea of **co-present interactions**, in which people are physically occupying the same space while interacting with one another. Historically, most interpersonal communication has involved co-present interactions, but with the advent of a range of communication technologies, people no longer have to be co-present to interact. On the flip side, there are many people who are co-present but use technology as a way of avoiding FtF interactions with those around them. One of our professor friends recently remarked, “when I started my career, I always had to tell students to quiet down at the beginning of class. Now, they’re already quiet because they’re all looking at their cellphones ignoring those around them.”

Now we often have to encourage collocated social interactions, and we wonder how we can get people sitting next to each other to talk to one another. Thomas Olsson, Pradthana Jarusriboonchai, Paweł Woźniak, Susanna Paasovaara, Kaisa Väänänen, and Andrés Lucero argue that there are two basic communication problems facing people today, “(1) the use of current technology disrupting ongoing social situations, and (2) lack of social interaction in collocated situations where it would be desirable.”²⁷ When people don’t interact with one another, they tend to become more socially isolated and lonely, which can lead to a feeling of disengagement with those around them.

How many times have you seen people eating out together yet spending the entire time on their smartphones? Many people believe that this type of multitasking actually enhances productivity, but research tends to disagree with this notion. One study actually demonstrated that when people are confronted with constant distractions like phones ringing or email alerts chiming on a smartphone, people lose an average of 10 IQ points due to these distractions.²⁸ This drop in IQ is equivalent to missing an entire night of sleep. Furthermore, those generations that have grown up with technology are more likely to engage in multitasking behavior.²⁹ In a 2014 study conducted by Jonathan Bowman and Roger Pace, the researchers tested the impact of cell phone usage vs. FtF conversations while performing a complex cognitive task.³⁰ Not surprisingly, individuals who interacted via cell phones were less adept at performing the task than those engaged in FtF interactions. Furthermore, individuals involved in the FtF interactions were more satisfied with their interactions than their peers using a cellphone. The authors of the article also found that, “People think they are effectively communicating their message while dual-tasking even though they are not.”³¹

So how can technology benefit social interactions? In the Olsson et al. study, the researchers examined several different studies that were designed to help foster collocated social interactions.³² Table 12.2 from the Olsson et al. illustrates the basic findings from their study.

Role of technology	Social design objectives	Design approaches
Enable (previous work beyond which the reviewed literature explores)		

Facilitate	<ul style="list-style-type: none"> • Facilitating ongoing social situations • Enriching means of social interaction • Supporting sense of community • Breaking ice in new encounters 	<ul style="list-style-type: none"> • Shared digital workspace • Open space for shared activity • Topic suggestions • Disclosing information about others
Invite	<ul style="list-style-type: none"> • Increasing awareness • Revealing common ground • Avoiding cocooning in social silos • Engaging people in collective activity 	<ul style="list-style-type: none"> • Open space for shared activity • Matchmaking • Self-expression • Topic suggestions • Open space for shared activity
Encourage	<ul style="list-style-type: none"> • Encouraging, incentivizing or triggering people to interact 	<ul style="list-style-type: none"> • Introducing constraints

<https://doi.org/10.1007/s10606-019-09345-0>

<http://creativecommons.org/licenses/by/4.0/>

Table 12.2 Mapping the social design objectives and design approaches interpreted from the papers to abstract enhancement categories (Roles of Technology)

In Table 12.2 you are introduced to four different ways that technology can help facilitate collocated social interaction. You are also presented with the design objectives for each of these different ways to encourage collocated social interaction along with specific design approaches that technology creators can use to help foster collocated social interaction. Let’s look at each of these in turn.

Enabling

First, “**enabling** interaction refers to the role of a technological artifact making it possible or allowing for social interaction to take place.”³³ The goal of enabling is to set up situations where collocated social interaction is possible. As such, there’s less information about specific design objectives and approaches even though most of the research in the area of helping people interact has historically focused on enabling.

Facilitating

Second, “**facilitating** interaction refers to making it easier to converse, collaborate or otherwise socially interact, or to support desirable feelings, equality or suitable interaction dynamics while doing so.”³⁴ The goal of facilitating collocated social interactions is to help ease tension and encourage people to interact while minimizing possible negative experiences people may face. One of the ways to achieve facilitating is to have an open space for a shared activity. For example, an online college or university may have coffee shop nights or alumni events in various cities. The alumni events don’t necessarily have specific agendas,

but the goal is to provide a space where people can meet and interact.

Inviting

Third, “**inviting** interaction is about the role of informing people of the available proximal social possibilities, which can motivate to spontaneously engage in new encounters.”³⁵ In this case, the focus is on providing people the ability to invite social interaction or respond to invitations to engage in social interaction. One of the best examples of this type of use of technology to help facilitate collocated social interaction is <https://www.meetup.com/>. Meetup provides a range of different activities and groups people can join that then meet up in the real-world. For example, in the next 24 hours, there is a Swing Dance Cruise, Writer’s Group, and Meditation Workshop I could go to just in my local area.

Encouraging

Lastly, “**encouraging** interaction is about incentivizing or persuading people to start interacting or maintaining ongoing interaction.”³⁶ In the case of encouraging, it’s not just about providing opportunities, but also using technology to help nudge people into collocated social interaction. For example, an application could require students in an online class who live near each other to get together to study or work on a course project together. You may notice that the common design approach here is introducing constraints. This means that people are required to meet up and engage in collocated social interaction to accomplish a task because neither can do it on their own. Video games have been using a version of this for years. In many social video games, a single player will not have all of the abilities, skills, weapons, etc. to accomplish a specific goal on their own. They must work with other players to accomplish a task. The only difference here is that the tasks are being completed in a FtF context instead of a mediated context.

Key Takeaways

- Synchronous communication is communication that happens in real time, whereas asynchronous communication has a time lag between the exchange of messages.
- Nonverbal behaviors are not inherent in many forms of computer-mediated communication. With text-based messages (email, texts, IRC, etc.), there are no nonverbal cues to attend to at all. In other mediated forms (e.g., Skype, Facetime, Zoom), we can see the other person, but it’s still not the same as an interaction in a FtF context.
- Netiquette is the set of professional and social rules and norms for acceptable and polite behaviors when interacting with another person(s) through mediating technologies.
- A number of human communication variables have been examined within the CMC context: communication apprehension, communication competence, etc.

Exercises

- Think about the asynchronous and synchronous computer-mediated communication technologies you use regularly. Are nonverbal behaviors filtered

- in or out? How does this impact your ability to understand the other person?
- Have you ever violated netiquette while interacting with other people? What happened? How did other people react?
- Take a few minutes to Google yourself and see what information is easily available about you on the Internet. You may need to try a couple of variations of your name and even add your hometown if your name is very common. If you find information about yourself, how could a potential employer react to that information? Do you need to clean up your Internet profile? Why?

12.3 Taking the Self Online

LEARNING OUTCOMES

1. Explain Erik Erikson's conceptualization of identity.
2. Describe how Erving Goffman's theory can help us explain online identities.
3. Discuss the three types of online identities described by Andrew F. Wood and Matthew J. Smith.

In Chapter 3, we discussed the world of intrapersonal communication. At the beginning of Chapter 3 chapter, we had you describe yourself by answering the question, “Who am I?” 20 different times. Look back at that list. Now, think about yourself in the CMC context. Are you the same person in a FtF interaction as you are in a CMC interaction? Maybe, but maybe not. For example, maybe you're a very shy person in FtF interactions, and likewise you have problems talking with complete strangers online. However, maybe you're a very quiet person in FtF interactions, but when you're playing World of Warcraft, you suddenly become very loud and boisterous. One of the beautiful things about CMC for many people is that they can be almost anyone or anything they want to be online. In this section, we're going to examine some specific factors related to one's online self: identity, personality traits, communication traits, privacy, anonymity, and trust.

Erik Erikson

Many social psychologists over the years have attempted to define and conceptualize what is meant by the term “identity.” One of the more prominent contributors to this endeavor was Erik Erikson. Erikson believed that an individual's identity was developed through a series of stages of psychosocial development that occur from infancy to adulthood. At each of the different stages, an individual faces various crises that will influence her/his/their identity positively or negatively. Each crisis pits the psychological needs of the individual against the larger needs of society, which is why these crises are psychosocial in nature. You can see these stages, the crises that occur, the basic virtues associated with the crises, and the central question that is asked at each stage in Figure 12.8.³⁷

Our question then, is how does technology impact an individual's identity development? To answer this question, we need to understand Erikson's concept of “pseudospeciation,” or the tendency of humans to try to differentiate themselves from other humans.³⁸ Basically, we create in-groups (groups to which we belong) and out-groups (groups to which we do not belong). As Erikson explained, humans

Psychosocial Crisis	Trust vs. Mistrust	Autonomy vs. Shame	Initiative vs. Guilt	Industry vs. Inferiority	Identity vs. Role Confusion	Intimacy vs. Isolation	Generativity vs. Stagnation	Ego Integrity vs. Despair
Basic Virtue	Hope	Will	Purpose	Competency	Fidelity	Love	Care	Wisdom
Age	0 to 1½	1½ to 3	3 to 5	5 to 12	12 to 18	18 to 40	40 to 65	65+
Key Question	Am I Safe?	Can I do it on my own, or do I need help?	Am I good or bad?	How can I be good?	Who am I, and where am I going?	Am I loved and wanted?	Will I provide something of real value?	Have I lived a full life?

Figure 12.8 Erikson’s Stages of Identity Development

have a need “to feel that they are of some special kind (tribe or nation, class or caste, family, occupation, or type), whose insignia they will wear with vanity and conviction, and defend (along with the economic claims they have staked out for their kind) against the foreign, the inimical, the not-so-human kinds.”³⁹ This need to differentiate ourselves from others is especially prominent in those individuals who are under 18 years of age.⁴⁰

Millennials came of age during the influx of new technologies associated with Web 2.0. Subsequent generations have grown up with technology from birth. Ever seen a baby using an iPad? It happens. Erikson died the same year as the first major Web browser, Netscape, came on the market. Obviously, he did not have anything to say about the influx of technology and identity formation specifically. However, he had seen the invention of other technologies and how they had impacted identity formation, specifically movies:

“interspersed with close-ups of violence and sexual possession and all this without making the slightest demand on intelligence, imagination, or effort. I am pointing here to a widespread imbalance in adolescent experience because I think it explains new kinds of adolescent outbursts and points to new necessities of mastery.”⁴¹

Avi Kay believes that today’s social media and other technologies are even more impactful than movies were in Erikson’s day:

An argument can certainly be made that the immediacy, pervasiveness, and intensity of the ideas and images afforded by the advent of movies pale compared to those of the Internet and social media. As such, reactions to those ideas and images via the Internet can only be expected to provoke even greater passions than those Erikson observed among the youth of his generation.⁴²

Kay specifically discusses how the Internet is being used as a tool to radicalize young people in Islamic

countries, and the same is also true of many young people in the United States who are radicalized through the Internet into hate groups here. The Internet is a fantastic tool, but the types of information that it can expose an adolescent to during their formative years can send them on a prosocial or anti-social path. Thankfully, there is hope. As Erikson said, “There is no reason to insist that a technological world, as such, need weaken inner resources of adaptation, which may, in fact, be replenished by the goodwill and ingenuity of a communicating species.”⁴³ Although many forces try to sway adolescents towards anti-social behavior and ideologies, technology isn’t inherently bad for identity formation. Technology can also be used to help forge positive identities.

Your Online Identity

We just discussed how an individual’s identity could be shaped by her/his/their interaction with technology, but what about the identity we display when we’re online. In the earliest days of the Internet, it was common for people to be completely anonymous on the Internet (more on this shortly). For our purposes, it’s important to realize that people often present themselves differently in CMC contexts. For example, someone chatting with a complete stranger on Tinder but completely differently when texting with her/his/their mother.

Erving Goffman and Identity

Erving Goffman, in his book *The Presentation of Self in Everyday Life*, was the first to note that when interacting with others, people tend to guide or control the presentation of themselves to the other person.⁴⁴ As people, we can alter how we look (to a degree), how we behave, and how we communicate, and all of these will impact the perception that someone builds of us during an interaction. And while we’re attempting to create an impression of ourselves, the other person is also attempting to create a perception of who you are as a person.

In an ideal world, we hope how we’re presenting ourselves will be how the other person interprets this self-presentation, but it doesn’t always work out that way. Goffman coined the term dramaturgical analysis to describe this type of interactive sensemaking because he saw the faces people put on when interacting with others as similar to the roles actors play onstage. In this respect, Goffman used the term “front stage” to the types of behavior we exhibit when we know others are watching us (e.g., an interpersonal interaction). “Backstage” then is the behavior we engage in when we have no audience present, so we are free from the rules and norms of interaction that govern our day-to-day interactions with others. Basically, when we are alone, we can let our hair down and relax by getting out of the character we perform on stage. At the same time, we also prepare for future interactions on stage while we’re backstage. For example, maybe a woman will practice a pick up line she plans on using in a bar after work, or a man will rehearse what he’s going to say when he meets his boyfriend’s parents at dinner that night.

Erving Goffman died in 1982 well before the birth of the WWW and the Internet as most of us know it today, so he didn’t write about the issue of online identities. Syed Murtaza Alfarid Hussain applied Goffman’s dramaturgical approach to Facebook.⁴⁵ Alfarid Hussain argues that Facebook can be seen as part of the “front stage” for interaction where we perform our identities. As such, Facebook “provides the opportunity for individuals to use props such as user profile information, photo posting/sharing/tagging, status updates, ‘Like’ and ‘Unlike’ others posts, comments or wall posts, profile image/cover page image, online befriending, group/community membership, weblinks and security and privacy settings.”⁴⁶ If you’re like us, maybe you sat in front of your smartphone, tablet computer, laptop, or desktop computer

and wanted to share a meme, but realized that many people you're friends with on Facebook wouldn't find the meme humorous, so you didn't share the meme. When you do this, you are negotiating your identity on stage. You are determining and influencing how others will view you through the types of posts you make, the shares you make, and even the likes you give to others' posts.

In a study examining identity in blogging and the online 3D multiverse SecondLife, Liam Bullingham and Ana C. Vasconcelos found that most people who blog and those who participated on SecondLife (in their study) "were keen to re-create their offline self online. This was achieved by creating a blogging voice that is true to the offline one, and by publishing personal details about the offline self online, or designing the avatar to resemble the offline self in SL, and in disclosing offline identity in SL."⁴⁷ In "Goffman-speak," people online attempt to mimic their onstage performances across different mediums. Now clearly, not everyone who blogs and hangs out in SecondLife will do this, but the majority of the individuals in Bullingham and Vasconcelos' study did. The authors noted differences between bloggers and SL users. Specifically, SL users have:

more obvious options to deviate from the offline self and adopt personae in terms of the appearance of the 3D avatar. In blogging, it is perhaps expected that persona adoption does not occur, unless a detachment from the offline self is obvious, such as in the case of pseudonymous blogging. Also, the nature of interaction is different, with blogging resembling more closely platform performances and the SL environment offering more opportunities for contacts and encounters.⁴⁸

Types of Online Identities

Unlike traditional FtF interactions, online interactions can blur identities as people act in ways impossible in FtF interaction. Andrew F. Wood and Matthew J. Smith discussed three different ways that people express their identities online: anonymous, pseudonymous, and real life (Figure 12.9).⁴⁹

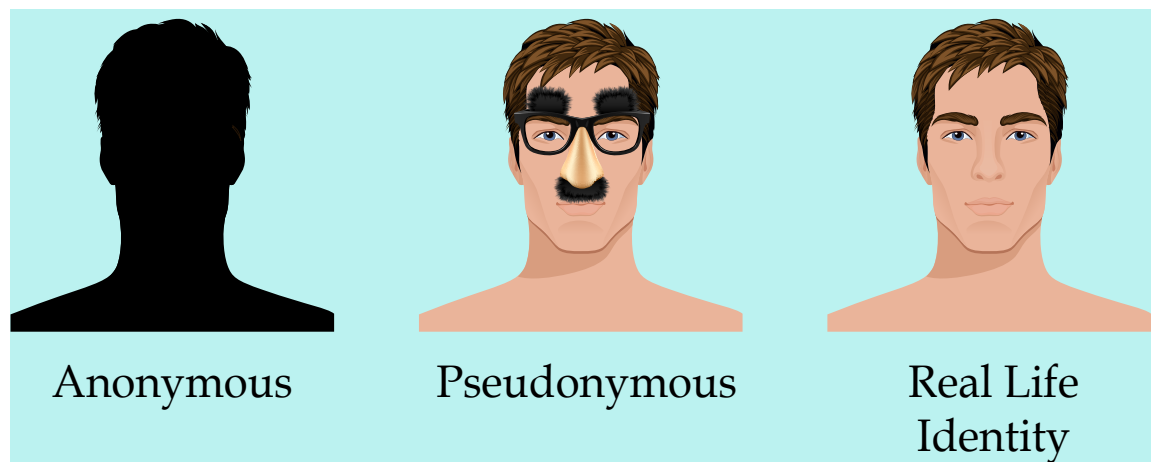

Figure 12.9 Types of Online Identities

Anonymous Identity

First, people in a CMC context can behave in a way that is completely **anonymous**. In this case, people in CMC interactions can communicate in a manner that conceals their actual identity. Now, it may be possible for some people to figure out who an anonymous person is (e.g., the NSA, the CIA), but if someone wants to maintain her or his anonymity, it's usually possible to do so. Think about how many fake Facebook, Twitter, Tinder, and Grindr accounts exist. Some exist to try to persuade you to go to a website (often for illicit purposes like hacking your computer), while others may be "catfishing" for the fun of it.

Catfishing is a deceptive activity perpetrated by Internet predators when they fabricate online identities on social networking sites to lure unsuspecting victims into an emotional/romantic relationship. In the 2010 documentary *Catfish*, we are introduced to Yaniv “Nev” Schulman, a New York-based photographer, who starts an online relationship with an 8-year-old prodigy named Abby via Facebook. Over the course of nine months, the two exchange more than 1,500 messages, and Abby’s family (mother, father, and sister) also become friends with Nev on Facebook. Throughout the documentary, Nev and his brother Ariel (who is also the documentarian) start noticing inconsistencies in various stories that are being told. Music that was allegedly created by Abby is found to be taken from YouTube. Ariel convinces Nev to continue the relationship knowing that there are inconsistencies and lies just to see how it will all play out. The success of *Catfish* spawned a television show by the same name on MTV.

From this one story, we can easily see the problems that can arise from anonymity on the Internet. Often behavior that would be deemed completely inappropriate in a FtF encounter suddenly becomes appropriate because it’s deemed “less real” by some. One of the major problems with online anonymity has been cyberbullying. Teenagers today can post horrible things about one another online without any worry that the messages will be linked back to them directly. Unlike FtF bullying victims who leave the bullying behind when they leave school, teens facing cyberbullying cannot even find peace at home because the Internet follows them everywhere. In 2013 12-year-old Rebecca Ann Sedwick committed suicide after being the perpetual victim of cyberbullying through social media apps on her phone. Some of the messages found on her phone after her suicide included, “Why are you still alive?” and “You haven’t killed yourself yet? Go jump off a building.” Rebecca suffered this barrage of bullying for over a year and by around 15 different girls in her school. Sadly, Rebecca’s tale is one that is all too familiar in today’s world. Nine percent of middle-school students reported being victims of cyberbullying, and there is a relationship between victimization and suicidal ideation.⁵⁰

It’s also important to understand that cyberbullying isn’t just a phenomenon that happens with children. A 2009 survey of Australian Manufacturing Workers’ Union members, found that 34% of respondents faced FtF bullying, and 10.7% faced cyberbullying. All of the individuals who were targets of cyberbullying were also bullied FtF.⁵¹

Many people prefer anonymity when interacting with others online, and there can be legitimate reasons to engage in online interactions with others. For example, when one of our authors was coming out as LGBTQIA+, our coauthor regularly talked with people online as they melded the new LGBTQIA+ identity with their Southern and Christian identities. Having the ability to talk anonymously with others allowed our coauthor to gradually come out by forming anonymous relationships with others dealing with the same issues.

Pseudonymous Identity

The second category of interaction is pseudonymous. Wood and Smith used the term pseudonymous because of the prefix “pseudonym”: “**Pseudonym** comes from the Latin words for ‘false’ and ‘name,’ and it provides an audience with the ability to attribute statements and actions to a common source [emphasis in original].”⁵² Whereas an anonym allows someone to be completely anonymous, a pseudonym “allows one to contribute to the fashioning of one’s own image.”⁵³

Using pseudonyms is hardly something new. Famed mystery author Agatha Christi wrote over 66 detective novels, but still published six romance novels using the pseudonym Mary Westmacott. Bestselling science fiction author Michael Crichton (of Jurassic Park fame), wrote under three different pseudonyms (John Lange, Jeffery Hudson, and Michael Douglas) when he was in medical school.

Even J. K. Rowling (of Harry Potter fame) used the pseudonym Robert Galbraith to write her follow-up novel to the series, *The Cuckoo's Calling* (2013). Rowling didn't want the media hype or inflated reader expectations while writing her follow-up novel. Unfortunately for Rowling, the secret didn't stay hidden very long.

There are many famous people who use pseudonyms in their social media: @TheTweetOfGod (comedy writer and Daily Show producer, David Javerbaum), @pewdiepie (online personality and producer Felix Arvid Ulf Kjellberg), @baddiewinkle (Octogenarian fashionista and online personality Helen Van Winkle), @doctor.mike (family practitioner and internet celebrity Dr. Mike Varshavski), and more. Some of these people used parts of their real names, and others used fully pseudonymous names. All of them have enormous Internet followings and have used their pseudonyms to build profitable brands. So, why do people use a pseudonym?

The veneer of the Internet allows us to determine how much of an identity we wish to front in online presentations. These images can range from a vague silhouette to a detailed snapshot. Whatever the degree of identity presented, however, it appears that control and empowerment are benefits for users of these communication technologies.”⁵⁴

Some people even adopt a pseudonym because their online actions may not be “on-brand” for their day-job or because they don't want to be fully exposed online.

Real Life Identity

Lastly, some people have their real-life identities displayed online. You can find JasonSWrench on Facebook, Instagram, Snapchat, Twitter, LinkedIn, etc.... Our coauthor made the decision to have his social networking site behavior very public from the beginning. Part of the reason was that when he first joined Facebook in 2007, he was required to use his professional school email address that ended with .edu. In the early days, only people with .edu email addresses could join Facebook. Jason also realizes that this behavior is a part of his professional persona, so he doesn't put anything on one of these sites he wouldn't want other professionals (or even you) to see and read. When it comes to people in the public eye, most of them use some variation of their real names to enhance their brands. That's not to say that many of these same people don't have multiple online accounts, some of which may be completely anonymous or even pseudonymous.

Key Takeaways

- Erikson believed that an individual's identity is developed through a series of stages of psychosocial development that occur from infancy to adulthood. At each stage, we face a different set of crises that pits an individual's psychological needs versus the larger societal needs. Part of this development is impacted by the introduction of new technologies, which can be both good for society and problematic.
- Erving Goffman in his book *The Presentation of Self in Everyday Life*, uses the term “front stage” to describe the types of behavior we exhibit when we know others are watching us (e.g., an interpersonal interaction), and he uses the term “backstage” to refer to behavior we engage in when we have no audience present, so we are free from the rules and norms of interaction that govern our day-to-day interactions

- with others.
- Andrew F. Wood and Matthew J. Smith discussed three specific types of online identities that people can formulate: anonymous (the person behind a message is completely unknown), pseudonymous (someone uses a pseudonym, but people often know who the real person behind the message is), and real life (when our online and FtF identities are the same).

Exercises

- Of the two theoretical approaches to identity (Erikson and Goffman), which do you think is the better tool for explaining how your online identity and offline identity were formed? Why?
- When it comes to your online CMC behavior, do you have an anonymous, pseudonymous, and real-life identity? How are these similar? How are they different?

12.4 Theories of Computer-Mediated Communication

LEARNING OUTCOMES

1. Describe uses and gratifications theory and how it helps us understand CMC behavior.
2. Describe social presence theory and how it helps us understand CMC behavior.
3. Describe media richness theory and how it helps us understand CMC behavior.
4. Describe social information processing theory and how it helps us understand CMC behavior.

Most of the early work in computer-mediated communication from a theoretical perspective was conducted using mediated-communication theories that have been developed to discuss the differences between print, radio, and television, and applying them to the Internet. As such, we don't see the proliferation of theories. In this section, we are going to explore four theories and their implications for CMC.

Uses and Gratifications Theory

The first major theory used to explain CMC is the uses and gratifications theory. **Uses and gratifications theory** was originally devised in the mid-1970s to explain why people use the types of mass media they do.⁵⁵ The basic premise of the theory is that people choose various media because they get something out of that media, or it makes them happy in some way. From this perspective, people choose various media because they have specific goals that they want to fulfill. Zizi Papacharissi and Alan Rubin were the first scholars to apply the uses and gratifications theory to how people use the Internet.⁵⁶

They found five basic reasons people were using the Internet: interpersonal utility (allows people to interact with others), pass time (helps people kill time), information seeking (people look for specific information they want or need), convenience (it's faster than FtF or even a phone call), and entertainment (people enjoy using the Internet). In this first study, the researchers found that people who used the Internet for interpersonal utility were less satisfied with life and more anxious in FtF communication interactions when compared to those who did not. Please remember that this study was conducted in 2000, so times are quite different now, so the finding from the Papacharissi and Rubin may be different if conducted today..

In a 2008 follow-up study, the picture of Internet socializing was quite different, so it's not surprising that the results were indicative of changes in public consumption.⁵⁷ The researchers found when people try to substitute FtF interpersonal interactions for CMC interactions, they do not find their CMC interactions as rewarding. Conversely, when people supplement their FtF interpersonal interactions with CMC interactions, they are fulfilled by those CMC interactions.

Social Presence Theory

The second major theory that has been used to help explain CMC is social presence theory. Social presence theory was created by John Short, Ederyn Williams, and Bruce Christie.⁵⁸ Presence is a psychological state of mind and how we relate to technology. When we are truly present, we forget that we are actually using technology. Presence is “at the heart of humans’ desire to use media to move beyond the limits of body and the sensory channels.”⁵⁹ Often the term “presence” when used in this contact refers to the physical world and how technology mimics the physical world. For example, when you put on a virtual reality helmet, how does your mind and body react? People who experience high levels of presence in a virtual reality simulation will experience real physiological effects. In one study, Dino Krupić, Barbara Žuro, and Philip Corr examined whether a virtual environment could stimulate fear responses in individuals who have a fear of heights.⁶⁰

In this study, individuals wore a virtual helmet and “walked the plank” To measure fear response, participants wore a moodmetric ring which measures electrodermal activity, which is a physiological indication of stress responses. Can VR be used to create physiological stress responses? Yes. We should also mention that the study also examined whether mindfulness practices could help decrease stress responses in VR settings, which it did.

Social presence then is “the degree to which we as individuals perceive another as a real person and any interaction between the two of us as a relationship.”⁶¹ Our perceptions of social presence are largely based on the degree to which we have the ability to interpret nonverbal cues from the people we are interacting with.

When it comes to CMC, various technologies will elicit varying degrees of perceptions of presence from people. For example, reading information on a website probably is not going to make you forget that you are reading text on a screen. On the other hand, if you're engaging in a conversation with your best friend via text messaging, you may forget about the technology and just view the interaction as a common one you have with your friend. In essence, people can vary in how they perceive social presence. One of our coauthors regularly has students in a CMC course spend time in a couple of virtual worlds like SecondLife and World of Warcraft. SecondLife is a virtual world where people can create avatar and interact in a 3D simulated environment. However, it's not a game - it's a 3D virtual world. There is no point system and there is no winning or beating the system. Instead, it's a place for people to socialize and interact. On the other hand, World of Warcraft (WOW) is first and foremost a game.

Although there are definitely highly interactive components involved in WOW and people make life-long friends in WOW, WOW is a virtual world that has a specific end result focused on winning.

These different worlds have different purposes, but people can feel highly present in either or both. When students who are not familiar with these virtual worlds enter them, they often have a hard time understanding how people can spend hours upon hours interacting with others within these virtual worlds. The students view this as a “strange” experience and experience no social presence at all. Conversely, people who “live” in these virtual worlds regularly experience high levels of social presence. We do know that those individuals who report higher levels of social presence tend to have more rewarding online interpersonal interactions and are more likely to perceive themselves as competent communicators within these mediated environments.⁶²

Media Richness Theory

The third major theory that has been applied to CMC is media richness theory. Media richness theory was first proposed by Richard L. Daft and Robert H. Lengel.⁶³ **Richness** is defined as “the potential information carrying capacity of data.”⁶⁴ In Lengel’s doctoral dissertation, he proposed that media varied in richness depending on how much information is provided through the communication.⁶⁵ For example, in print media, all we have is text. As such, we don’t have nonverbal behaviors of the author to help us interpret the words we are reading. With FtF communication, on the other hand, we have the full realm of nonverbal behaviors that we can attend to in an effort to understand the sender’s message. As such, Lengel argued that media escalates in richness in the following order: computer output, formal memos, personal memos, telephone conversations, and FtF interactions. You’ll notice that this analysis of media was originally designed to help individuals understand the media choices organizational members have in the workplace.

So, where does this leave us with CMC? Well, from the basic premise of media richness theory, we can ascertain that the richer the media, the less ambiguous a message is for a receiver.⁶⁶

Social Information Processing Theory

Up to this point, the first three theories we examined that have been used to explain why people use CMC have all been theories originally designed to examine media before the proliferation of CMC. The first truly unique theory designed to look at CMC from a communication perspective came from Joseph Walther’s social information processing theory, in 1992.⁶⁷ As someone with a background in communication, Walther realized that our impressions of those we interact with and our interpersonal interactions with them change over time, yet the previous three theories applied to CMC didn’t take into account how interpersonal relationships evolve as the interactants spend more time getting to know one another. For example, both media richness theory and social presence theory focus on the nonverbal aspects of CMC and assume that because of the lack of nonverbal cues in CMC, people will inherently find it inherently less rich and/or less present when compared to FtF interactions. Walther argues that the filtering out of nonverbal cues doesn’t hinder an individual’s ability to form an impression of someone over time in a CMC context. Walther asserts that over time, relationships formed in a CMC context can develop like those that are FtF. He does admit that these relationships will take more time to develop, but the relationships can reach the same end states as relationships formed FtF.

Walther later expanded his ideas of social information processing to include a new concept he dubbed hyperpersonal interactions.⁶⁸ **Hyperpersonal** interactions are those that go above and beyond

those possible in traditional FtF interactions. For example, many people who belong to online self-help groups discuss feelings and ideas that they would never dream of discussing with people in an FtF interaction unless that person was their therapist. Furthermore, during CMC interactions an individual can refine their message in a manner that is impossible to do during an FtF interaction, which help them present a specific face to an interactant. I'm sure we've all written a text, Facebook post, or email and then decided to delete what we'd just written rather than post or send it because it was not in our best interest to put it out in the world. In CMC interactions, we have this ability to fine-tune our messages before transmitting, whereas in FtF messages, we don't have the ability to sit and ponder our responses writing and rewriting them until we're ready to orally communicate during a FtF interaction. Furthermore, in FtF interactions, there is an expectation that the interaction keeps moving at a steady pace without the ability to edit one's ideas; whereas, with CMC we can take time to fine-tune our messages in a way that is impossible during an FtF interaction. All of this helps an individual create the public face that they want to be known by.

Key Takeaways

- Uses and gratifications theory helps explain why people use the types of mass media they do. Papacharissi and Rubin found that there were five reasons why people use the Internet: interpersonal utility (allows people to interact with others), pass time (helps people kill time), information seeking (enables people to locate specific information they want or need), convenience (it's faster than FtF or even a phone call), and entertainment (people enjoy using the Internet).
- Social presence theory helps us understand whether or not individuals using CMC technologies perceive the people they are interacting with as "real." Our perceptions of social presence are largely based on the degree to which we can interpret nonverbal cues from the people we are interacting with.
- Media richness theory helps us understand CMC behavior by examining the capacity that a type of media has for transmitting data. As media becomes richer and has more nonverbal content, the easier it is for a receiver to interpret the message accurately, which can, in turn, lead to more successful social interactions online.
- Social information processing (SIP) theory helps researchers understand the development of interpersonal relationships in CMC contexts. SIP argues that overtime relationships formed in a CMC context can develop like those relationships that develop FtF.

Exercises

- Uses and gratifications theory is one of the oldest theories in media, and continues to be one of the most commonly studied. For this exercise, find a research study conducted in the previous five years that examines gratifications theory as related to CMC. Look for the outcomes from that specific study and report them back to your class.
- Compare and contrast social presence theory, media richness theory, and

social information processing theory and their explanation of the importance of nonverbal communication in CMC relationships.

- If you've experienced a hyperpersonal relationship online, think about that relationship as you answer the following questions. If you have not had a hyperpersonal relationship online, then talk with someone who has and answer the following questions.
 - How did this hyperpersonal relationship develop?
 - What was different about this relationship when compared to FtF relationships?
 - Do you still have this relationship today? Why or why not?

Chapter Wrap-Up

This chapter explored many of the ways that modern communication technologies help us interact with each other. Whether we're talking over a headset to someone through our gaming console or texting our roommate, we use these technologies to communicate with people all the time. The first part of this chapter explored the history of computer-mediated communication, which was followed by a discussion of the process of computer-mediated communication. We then discussed identity formation in virtual environments. We ended the chapter by looking at four of the most commonly discussed theories related to computer-mediated communication. Hopefully, you realize that this chapter barely scratches the surface when it comes to how people are using technology to create and enhance their interpersonal

End of Chapter

KEY TERMS

- Anonymous CMC Identities
- ARPANET
- Asynchronous Communication
- Catfishing
- Co-Present Interactions
- Emoticons
- Hyperpersonal
- Impression Formation
- Message/Bulletin Boards
- Netiquette
- Pseudonymity CMC Identity
- Real-life CMC Identity
- Richness
- Social Presence
- Synchronous Communication
- Uses and Gratifications Theory

REAL WORLD CASE STUDY

relationships.

Jenny wasn't meeting any potential boyfriends living in Denver. As a 28-year-old woman, she's found meeting people more and more difficult. She's not really into the bar scene, so meeting people in that environment is pretty much out. One day a friend of hers at work tells her about a new smartphone app called Fndr. The app allows people to see how many people are also looking for dates within a geographic location.

She decides to download the app and see what all of the fuss is about. She creates a profile, uploads a professional picture, and decides to take a chance. Immediately, she sees a screen filled with men all looking for relationships. There is Chad, who is 1.5 miles away. There is Andrew, who is 678 feet from her. Then there was Bobby, who was less than 100 feet from her. *That's very creepy*, Jenny thinks to herself. She looks at Bobby's profile, which shows a picture of a bare-chested male torso. *God, he's ripped!* She looks at another photo that shows his back flexed. That's when she notices his eagle tattoo on the bottom center of his back. *Oh my god! That's Martha's Husband!!!*

1. If you were Jenny, how would you respond to finding someone's husband on a social media site for people looking for relationships?
1. Do you think Jenny should confront Martha's husband through Fndr?
2. Do you think computer-mediated communication has made infidelity in the 21st Century easier?

END OF CHAPTER QUIZ

1. What is the term for principles for behavior and communication that are appropriate and effective in workplace settings called?
 - a. professionalism
 - b. communication competence
 - c. communication intelligence
 - d. etiquette
 - e. formality
2. Rob just received an email from one of his employees. The email is all in lowercase with zero punctuation. Rob only knows when a new sentence is reached when a capital letter rises out of nowhere. Rob's employee has violated what?
 - a. CMC norms
 - b. CMC rules
 - c. netiquette
 - d. nonverbal cues
 - e. presence
3. Max writes fan fiction that he publishes on WattPad under the name M.L. Patterson. He has a pretty large following of readers. He's recently realized that most of his readers assume that he's a female based on the use of his initials instead of his first name. What type of identity does Max's WattPad presence most represent?
 - a. anonymous
 - b. pseudonymous
 - c. real life
 - d. non-identifiable
 - e. identifiable
4. Dae-Jae is a computer designer in Korea. He works in the training department of a large multinational automobile company. He's been tasked with creating a new virtual training program for salespeople around the world. One of his biggest concerns is ensuring that the game he designs for this training is able to immerse people in as a realistic environment as possible. Dae-Jae really wants learners to feel like they are interacting with a real customer. Which theory of mediated communication best

describes what Dae-Jae is concerned with?

- a. media richness theory
 - b. social presence theory
 - c. medium is the message
 - d. social information processing theory
 - e. uses and gratifications theory
5. Alima is hanging out with her best friend at a local diner. She's chit-chatting with her best friend, but both of them are also constantly texting other people. What type of interaction does this example most clearly illustrate?
- a. co-present
 - b. dual-processing
 - c. effective
 - d. communicatively competent
 - e. rewarding

References

- 1 Holland, B. (2018, August 22). Human computers: The women of NASA. *The History Channel*. <https://www.history.com/news/human-computers-women-at-nasa>
- 2 Campbell-Kelly, Aspray, W., Ensbeneger, N., & Yost, J. R. (2014). *Computer: A history of the information machine* (3rd ed.). Westview Press.
- Frauenfelder, M. (2013). *The computer: an illustrated history from its origins to the present day*. Carlton.
- Garfinkle, S. L., & Grunspan, R. H. (2018). *The computer book: From the abacus to artificial intelligence, 250 milestones in the history of computer science*. Sterling.
- 3 Raz, G. (2019, October 29). 'Lo' and behold: A communication revolution. *National Public Radio*. <https://www.npr.org/templates/story/story.php?storyId=114280698>
- 4 Happy 25th, Emoticon. (2007, Summer). Carnegie Mellon University. Retrieved from <https://www.cmu.edu/homepage/beyond/2007/summer/happy-25th-emoticon.shtml>; para. 5.
- 5 Berners-Lee, T. (1990, May). Information management: A proposal. Retrieved from <http://cds.cern.ch/record/369245/files/dd-89-001.pdf>; pg. 3.
- 6 Ibid.; pg. 3.
- 7 Berners-Lee, T., & Cailliau, R. (1990, November 12). WorldWideWeb: A proposal for a HyperText project. Retrieved from http://cds.cern.ch/record/2639699/files/Proposal_Nov-1990.pdf
- 8 What is HTML5? (2013, December 12). Retrieved from <https://www.w3.org/html/wiki/FAQs>
- 9 Culnan, M. J., & Markus, M. L. (1987). Information technologies. In F. M. Jablin, L. L. Putman, K. H. Roberts, and L. W. Porter (Eds.), *Handbook of organizational communication: An interdisciplinary perspective* (pp. 420-443). Sage.
- 10 Culnan, M. J., & Markus, M. L. (1987). Information technologies. In F. M. Jablin, L. L. Putman, K. H. Roberts, and L. W. Porter (Eds.), *Handbook of organizational communication: An interdisciplinary perspective* (pp. 420-443). Sage; pg. 423.
- 11 Twitter. (n.d.). Hateful conduct policy. Retrieved from: <https://help.twitter.com/en/rules-and-policies/hateful-conduct-policy>
- 12 Decot, D. (1984, March 13). ***Asterisks***. Retrieved from: <https://groups.google.com/forum/#%21msg/net.flame/VbghoeOfwyI/E2mCIWj2GV8J>
- 13 Brown, K. W., & Ryan, R. M. (2003). The benefits of being present: Mindfulness and its role in psychological well-being. *Journal of Personality and Social Psychology*, 84(2), 822–848. <https://doi.org/10.1037/0022-3514.84.4.822>
- 14 Abblett, M. (2019, September 3). 5 rules for sharing genuinely and safely online: No matter what kind of social community you find yourself in, it is important to abide by a few specific guidelines for safe sharing. *Mindful*. <https://www.mindful.org/5-rules-for-sharing-genuinely-and-safely-online/>
- 15 Campbell, S. W., & Neer, M. R. (2001). The relationship of communication apprehension and interaction involvement to perceptions of computer-mediated communication. *Communication Research Reports*, 18(4), 391–398. <https://doi.org/10.1080/08824090109384820>
- 16 Ibid.; pgs. 396-397.
- 17 Spitzberg, B. H. (2006). Preliminary development of a model and measure of computer mediated communication (CMC) competence. *Journal of Computer-Mediated Communication*, 11(2), 629–666. <https://doi.org/10.1111/j.1083-6101.2006.00030.x>
- 18 Hunt, D., Atkin, D., & Krishnan, A. (2012). The influence of computer-mediated communication apprehension on motives for Facebook use. *Journal of Broadcasting & Electronic Media*, 56(2), 187–202. <https://doi.org/10.1080/08838151.2012.678717>
- 19 Punyanunt-Carter, N. M., De La Cruz, J. J., & Wrench, J. S. (2017). Investigating the relationships among college students' satisfaction, addiction, needs, communication apprehension, motives, and uses & gratifications with Snapchat. *Computers in Human Behavior*, 75, 870–875. <https://doi.org/10.1016/j.chb.2017.06.034>
- 20 Punyanunt-Carter, N. M., Cruz, J. J. D. L., & Wrench, J. S. (2018). Analyzing college students' social me-

dia communication apprehension. *CyberPsychology, Behavior & Social Networking*, 21(8), 511–515. <https://doi.org/10.1089/cyber.2018.0098>

21 CareerBuilder.com. (2018, August 9). *More than half of employers have found content on social media that caused them NOT to hire a candidate, according to recent CareerBuilder survey* [Press Release]. Retrieved from: <http://press.careerbuilder.com/2018-08-09-More-Than-Half-of-Employers-Have-Found-Content-on-Social-Media-That-Caused-Them-NOT-to-Hire-a-Candidate-According-to-Recent-CareerBuilder-Survey>

22 Ibid.

23 Ibid.; para. 6.

24 Ibid.; para. 7.

25 obVite (2013). *2013 social recruiting survey results*. San Mateo, CA: Author.

26 Pitcan, M., Marwick, A. E., & Boyd, d. (2018). Performing a vanilla self: Respectability politics, social class, and the digital world. *Journal of Computer-Mediated Communication*, 23(3), 163-179. <https://doi.org/10.1093/jcmc/zmy008>; pg. 170.

27 Olsson, T., Jarusriboonchai, P., Woźniak, P., Paasovaara, S., Väänänen, K., & Lucero, A. (2019, February 14). Technologies for enhancing collocated social interaction: Review of design solutions and approaches. *Computer Supported Cooperative Work*. <https://doi.org/10.1007/s10606-019-09345-0>; pg. 2

28 Hewlett-Packard (2005). Abuse of technology can reduce UK workers' intelligence. Small & Medium Business press release, April 22. Retrieved July 11, 2014, from <http://www.scribd.com/doc/6910385/Abuse-of-technology-can-reduce-UK-workers-intelligence>

29 Carrier, L. M., Cheever, N. A., Rosena, L. D., Benitez, S., & Chang, J. (2009). Multitasking across generations: Multitasking choices and difficulty ratings in three generations of Americans. *Computers in Human Behavior*, 25(2), 483-489. <https://doi.org/10.1016/j.chb.2008.10.012>

30 Bowman, J. M., & Pace, R. C. (2014). Dual-tasking effects on outcomes of mobile communication technologies. *Communication Research Reports*, 31(2), 221-231. <https://doi.org/10.1080/08824096.2014.907149>

31 Ibid.; pg. 228.

32 Olsson, T., Jarusriboonchai, P., Woźniak, P., Paasovaara, S., Väänänen, K., & Lucero, A. (2019, February 14). Technologies for enhancing collocated social interaction: Review of design solutions and approaches. *Computer Supported Cooperative Work*. <https://doi.org/10.1007/s10606-019-09345-0>

33 Ibid.; pg. 39

34 Ibid.; pg. 39

35 Ibid.; pg. 40

36 Ibid.; pg. 40

37 Erikson, E. H. (1968). *Identity: Youth and crisis*. W. W. Norton & Company.

38 Erikson, E. (1985). Pseudospeciation in the nuclear age. *Political Psychology*, 6(2), 213–217. <https://doi.org/10.2307/3790901>

39 Erikson, E. H. (1962). Reality and actuality an address. *Journal of The American Psychoanalytic Association*, 10(3), 451-474. <https://doi.org/10.1177/000306516201000301>

40 Erikson, E. H. (1988). Youth: Fidelity and diversity. *Daedalus*, 117(3), 1–24.

41 Ibid.; pg. 11.

42 Kay, A. (2018). Erikson Online: Identity and pseudospeciation in the Internet age. *Identity: An International Journal of Theory and Research*, 18(4), 264-273. <https://doi.org/10.1080/15283488.2018.1523732>; pg. 269.

43 Erikson, E. (1964). *Insight and responsibility*. Norton; pg. 103-104.

44 Goffman, E. (1959). *The presentation of self in everyday life*. Anchor Books.

45 Alfarid Hussain, S. M. (2015). Presentation of self among social media users in Assam: Appropriating Goffman to Facebook users' engagement with online communities. *Global Media Journal: Indian Edition*, 6(1&2), 1–14. <https://tinyurl.com/sblll8a>

46 Alfarid Hussain, S. M. (2015). Presentation of self among social media users in Assam: Appropriating Goffman to Facebook users' engagement with online communities. *Global Media Journal: Indian Edition*, 6(1&2), 1–14. <https://tinyurl.com/sblll8a>; pg. 3.

- 47 Bullingham, L., & Vasconcelos, A. C. (2013). "The presentation of self in the online world." Goffman and the study of online identities. *Journal of Information Science*, 39(1), 101–112. <https://doi.org/10.1177/0165551512470051>; pg. 110.
- 48 Ibid.; pg. 110.
- 49 Wood, A. F., & Smith, M. J. (2005). *Online communication: Linking technology, identity, & culture* (2nd ed.). Routledge.
- 50 Hinduja, S., & Patchin, J. W. (2010). Bullying, cyberbullying, and suicide. *Archives of Suicide Research*, 14, 206-221.
- 51 Privitera, C. (2009). Cyberbullying: The new face of workplace bullying? *Cyberpsychology & Behavior*, 12(4), 395-400. <https://doi.org/10.1089/cpb.2009.0025>
- 52 Wood, A. F., & Smith, M. J. (2005). *Online communication: Linking technology, identity, & culture* (2nd ed.). Routledge; pg. 64.
- 53 Ibid.; pg. 66.
- 54 Ibid.; pgs. 66-67.
- 55 Katz, E., Blumler, J. G., & Gurevitch, M. (1974). Utilization of mass communication by the individual. In J. G. Blumler, & E. Katz (Eds.), *The uses of mass communications: Current perspectives on gratifications research* (pp. 19-32).: Sage.
- 56 Papacharissi, Z. & Rubin, A. M. (2000). Predictors of Internet use. *Journal of Broadcasting & Electronic Media*, 44(2), 175–196. https://doi.org/10.1207/s15506878jobem4402_2
- 57 Pornsakulvanich, V., Haridakis, P., & Rubin, A. M. (2008). The influence of dispositions and Internet motivation on online communication satisfaction and relationship closeness. *Computers in Human Behavior*, 24(5), 2292–2310. <https://doi.org/10.1016/j.chb.2007.11.003>
- 58 Short, J. A., Williams, E., & Christie, B. (1976). *The social psychology of telecommunications*. Wiley.
- 59 Lee, K.-M., & Nass, C. (2005). Social-psychological origins of feelings of presence: Creating social presence with machine-generated voices. *Media Psychology*, 7(1), 31-45. https://doi.org/10.1207/S1532785X-MEP0701_2
- 60 Krupić, D., Žuro, B., & Corr, P. J. (in press). Anxiety and threat magnification in subjective and physiological responses of fear of heights induced by virtual reality. *Personality and Individual Differences*. <https://doi.org/10.1016/j.paid.2019.109720>
- 61 Wood, A. F., & Smith, M. J. (2005). *Online communication: Linking technology, identity, & culture* (2nd ed.). Routledge; pg. 72.
- 62 Wrench, J. S., & Punyanunt-Carter, N. M. (2007). The relationship between computer-mediated-communication competence, apprehension, self-efficacy, perceived confidence, and social presence. *Southern Journal of Communication*, 72(4), 355-378. <https://doi.org/10.1080/10417940701667696>
- 63 Daft, R. L., & Lengel, R. H. (1983, May). *Information richness: A new approach to managerial behavior and organization design* (Report no. TR-ONR-DG-02). Office of Naval Research.
- 64 Ibid.; pg. 7.
- 65 Lengel, R. H. (1983). *Managerial information process and communication-media source selection behavior* [Unpublished Doctoral Dissertation]. Texas A&M University.
- 66 D'Ambra, J. D., Rice, R. E., & O'Conner, M. (1998). Computer-mediated communication and media preference: An investigation of the dimensionality of perceived task equivocality and media richness. *Behaviour and Information Technology*, 17(3), 164-174. <https://doi.org/10.1080/014492998119535>
- 67 Walther, J. B. (1992). Interpersonal effects in computer-mediated interaction: A relational perspective. *Communication Research*, 19(1), 52–90. <https://doi.org/10.1177/009365092019001003>
- 68 Walther, J. B. (1996). Computer-mediated communication: Impersonal, interpersonal, and hyperpersonal interaction. *Communication Research*, 23(1), 3-43. <https://doi.org/10.1177/009365096023001001>

END OF CHAPTER QUIZ

ANSWER KEY

1) A 2) A 3) B 4) B 5) A





Image by [Gerd Altmann](#) from [Pixabay](#)

Chapter 13

Interpersonal Relationships at Work

Second to spending time with your family, you'll probably end up spending more time working than anything else you do for the rest of your life (besides sleeping). Figure 13.1 shows you what the average full-time working person's day is like.

During the five-day work week, we spend more time with the people we work with than the people we live with during the five-day workweek. So, it shouldn't be too surprising that our workplace relationships tend to be very important to our overall quality of life. In previous chapters, we've looked at the importance of a range of different types of relationships. In this chapter, we're going to explore some areas directly related to workplace interpersonal relationships, including professionalism, leader-follower relationships, workplace friendships, romantic relationships in the workplace, and problematic workplace relationships. Finally, we'll end this chapter by discussing essential communication skills for work in the 21st Century.

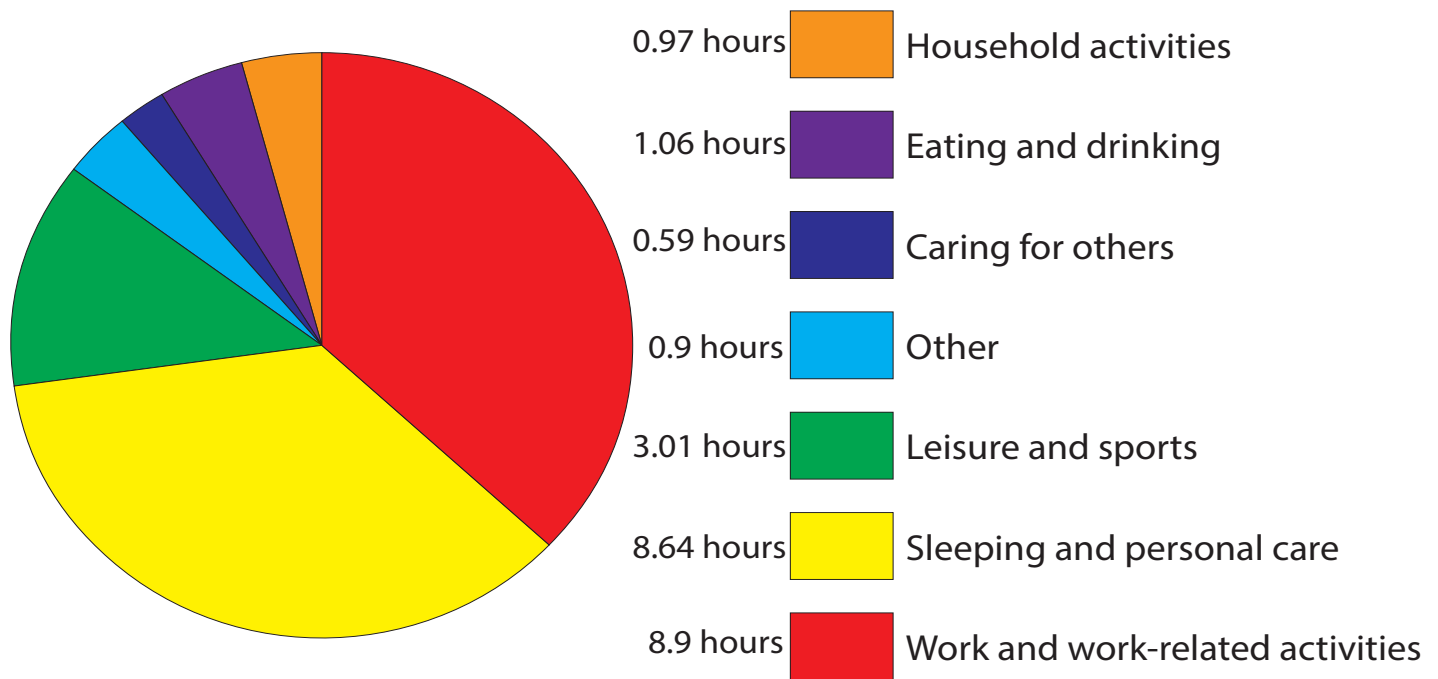

Average hours per day spent in selected activities on days worked by employment status.

SOURCE: Bureau of Labor Statistics, American Time Use Survey, 2017

Figure 13.1 Daily Life Breakdown

13.1 The Requirements of Professionalism

LEARNING OUTCOMES

1. Define the terms profession and professionalism.
2. Define the term “ethics” and recall several modern ethical lapses in organizations.
3. Understand the importance of respecting one’s coworkers.
4. Explain the concept of personal responsibility in the workplace.
5. Differentiate between formal and informal language.

What is professionalism? A **profession** is an occupation that involves mastery of complex knowledge and skills through prolonged training, education, or practical experience. Becoming a member of a specific profession doesn’t happen overnight. Whether you seek to be a public relations expert, lawyer, doctor, teacher, welder, or electrician, each profession requires interested parties to invest themselves in learning to become a professional or a member of a profession who earns their living through specified expert activity. It’s much easier to define the terms “profession” and “professional” than it is to define the term “professionalism” because each profession will have its take on what it means to be a professional within a given field.

According to the United States Department of Labor,¹ professionalism “does not mean wearing a suit or carrying a briefcase; rather, it means conducting oneself with responsibility, integrity, accountability, and excellence. It means communicating effectively and appropriately and always finding a way to

be productive.” The U.S. Department of Labor’s book *Skills to Pay the Bills: Mastering Soft Skills for Workplace Success* goes on to note:

Professionalism isn’t one thing; it’s a combination of qualities. A professional employee arrives on time for work and manages time effectively. Professional workers take responsibility for their own behavior and work effectively with others. High-quality work standards, honesty, and integrity are also part of the package. Professional employees look clean and neat and dress appropriately for the job. Communicating effectively and appropriately for the workplace is also an essential part of professionalism.²

The Requirements of Professionalism

As you can see here, professionalism isn’t a single “thing” that can be labeled. Instead, **professionalism** refers to the aims and behaviors that demonstrate an individual’s level of competence expected by a professional within a given profession. By the word “aims,” we mean that someone who exhibits professionalism is guided by a set of goals in a professional setting. Whether the aim is to complete a project on time or help ensure higher quarterly incomes for their organization, professionalism involves striving to help one’s organization achieve specific goals. By “behaviors,” we mean specific ways of behaving and communicating within an organizational environment. Some common behaviors can include acting ethically, respecting others, collaborating effectively, taking personal and professional responsibility, and using language professionally. Let’s look at each of these separately.

Ethics

Every year there are lapses in ethical judgment by organizations and organizational members. For our purposes, let’s look at ethical lapses in 2017 and 2018.

1. We saw aviation police officers drag a bloodied pulmonologist off a plane when he wouldn’t give up his seat on United Airlines.
2. We saw the beginnings of the #MeToo movement in October 2017 after Alyssa Milano uses the hashtag in response to actor Ashley Judd accusing media mogul Harvey Weinstein of serious sexual misconduct in an article within *The New York Times*. Since that critical moment, many courageous victims of sexual violence have raised their voices to take on the male elites in our society who had gotten away with these behaviors for decades.¹
3. Facebook (among others) was found to have accepted advertisements indirectly paid for by the Kremlin that influenced the 2016 election. The paid advertisements constituted a type of cyber warfare.
4. Equifax had a data breach that affected 145 million people (mostly U.S. citizens as well as some British and Canadian customers) and didn’t publicly disclose this for two months.
5. The head of the Environmental Protection Agency (EPA), Scott Pruitt, committed many ethical lapses during his tenure with the agency prompting his resignation. Some of the ethical lapses included ordering raises for two aides even when White House rejected them, spending \$3.5 million (twice times as much as his predecessor) on taxpayer-funded security, using that security to pick up his favorite moisturizing lotion and dry-cleaning, renting a room from a lobbyist who

¹ Although #MeToo gained popularity in 2017, the phrase was originally coined in 2006 by Tarana Burke to help women and girls of color who had survived sexual assault and violence.

had dealings with the EPA for \$50 per night, installing a \$43,000 private phone booth in his office that allegedly was used once, spending \$124,000 on first-class flights, purchasing two season-ticket seats at a University of Kentucky basketball game from a billionaire coal executive, tried to use his position to get his wife a Chick-fil-A franchise, and others.

Sadly, these ethical lapses are still frequent in corporate America, and they often come with huge lawsuit settlements and jail time.

The word “ethics” actually is derived from the Greek word *ethos*, which means the nature or disposition of a culture.³ From this perspective, ethics then involves the moral center of a culture that governs behavior. Without getting too deep, let’s just say that philosophers debate the very nature of ethics, and they have described a wide range of different philosophical perspectives on what constitutes ethics. For our purposes, **ethics** is the judgmental attachment to whether something is good, right, or just.

In the business world, we often talk about business ethics, which involves things like not stealing from a company; not lying to one’s boss, coworkers, customers, or clients; not taking bribes, payoffs, or kickbacks; not taking credit for someone else’s work; not abusing and belittling someone in the workplace; or simply letting other people get away with unethical behavior. For example, if you know your organization has a zero-tolerance policy for workplace discrimination and you know that one supervisor is purposefully not hiring pregnant women because “they’ll just be leaving on maternity leave soon anyway,” then you are just as responsible as that supervisor. We might also add that discriminating against someone who is pregnant or can get pregnant is also a violation of Equal Employment Opportunity law, so you can see that often the line between ethics and rules (or laws) can be blurred.

From a communication perspective, there are also ethical issues that you should be aware of. W. Charles Redding, the “father” of organizational communication, breaks down unethical organizational communication into six specific categories (Table 13.1).⁴

An organizational communication act is unethical if it is. ..	Such organizational communication unethically. ..
coercive	<ul style="list-style-type: none"> • abuses power or authority • unjustifiably invades others’ autonomy • stigmatizes dissents • restricts freedom of speech • refuses to listen • uses rules to stifle discussion and complaints
destructive	<ul style="list-style-type: none"> • attacks others’ self-esteem, reputations, or feelings • disregards other’s values • engages in insults, innuendoes, epithets, or derogatory jokes • uses put-downs, backstabbing, and character assassination • employs so-called “truth” as a weapon • violates confidentiality and privacy to gain an advantage • withholds constructive feedback
deceptive	<ul style="list-style-type: none"> • willfully perverts the truth to deceive, cheat, or defraud • sends evasive or deliberately misleading or ambiguous messages • employs bureaucratic euphemisms to cover up the truth

intrusive	<ul style="list-style-type: none"> • uses hidden cameras • taps telephones • employs computer technologies to monitor employee behavior • disregards legitimate privacy rights
secretive	<ul style="list-style-type: none"> • uses silence and unresponsiveness • hoards information • hides wrongdoing or ineptness
manipulative/ exploitative	<ul style="list-style-type: none"> • uses demagoguery • gains compliance by exploiting fear, prejudice, or ignorance • patronizes or is condescending toward others

Reprinted with permission from Wrench, Pinyanunt, and Ward's book *Organizational Communication: Theory, Practice, and Research* (2014, Flat World Knowledge)

Table 13.1. Redding's Typology of Unethical Communication

As you can see, unethical organizational communication is an area many people do not overly consider

Respect for Others

Our second category related to professionalism is respecting others. In Disney's 1942 movie, *Bambi*, Thumper sees the young Bambi learning to walk, which leads to the following interaction with his mother:

Thumper: He doesn't walk very good, does he?

Mrs. Rabbit: Thumper!

Thumper: Yes, Mama?

Mrs. Rabbit: What did your father tell you this morning?

Thumper: If you can't say something nice, don't say nothing at all.

Sadly, many people exist in the modern workplace that need a refresher in respect from Mrs. Rabbit today. From workplace bullying to sexual harassment, many people simply do not always treat people with dignity and respect in the workplace. So, what do we mean by treating someone with respect? There are a lot of behaviors one can engage in that are respectful if you're interacting with coworkers, leaders, or followers. Here's a list we created of respectful behaviors for workplace interactions:

- Be courteous, polite, and kind to everyone.
- Do not criticize or nitpick at little inconsequential things.
- Do not engage in patronizing or demeaning behaviors.
- Don't engage in physically hostile body language.
- Don't roll your eyes when your coworkers are talking.
- Don't use an aggressive tone of voice when talking with coworkers.
- Encourage coworkers to express opinions and ideas.

- Encourage your coworkers to demonstrate respect to each other as well.
- Listen to your coworkers openly without expressing judgment before they’ve finished speaking.
- Listen to your coworkers without cutting them off or speaking over them.
- Make sure you treat all of your coworkers fairly and equally.
- Make sure your facial expressions are appropriate and not aggressive.
- Never engage in verbally aggressive behavior: insults, name-calling, rumor mongering, disparaging, and putting people or their ideas down.
- Praise your coworkers more often than you criticize them. Point out when they’re doing great things, not just when they’re doing “wrong” things.
- Provide an equal opportunity for all coworkers to provide insight and input during meetings.
- Treat people the same regardless of age, gender, race, religion, sex, sexual orientation, etc.
- When expressing judgment, focus on criticizing ideas, and not the person.

Now that we’ve looked a wide range of ways that you can show your respect for your coworkers, we would be remiss if we didn’t bring up one specific area where you can demonstrate respect: the language we use. In a recent meeting, one of our coauthors was reporting on some work that was being completed on campus and let people in the meeting know that some people were already “grandfathered in” to the pre-existing process. Without really intending to, our coauthor had used gendered language. One of the other people in the room quickly quipped, “or grandmothered.” Upon contemplation, our coauthor realized that the seemingly innocuous use of the phrase “grandfathered in,” which admittedly is very common, is one that has a gendered connotation that limits it to males. Even though our coauthor’s purpose had never been to engage in sexist language, the English language is filled with sexist language examples, and they come all too quickly to many of us because of tradition and the way we were taught the language. This experience was a perfect reminder for our coauthor about the importance of thinking about sexist and biased language and how it impacts the workplace. Table 13.2 is a list of common sexist or biased language and corresponding inclusive terms that one could use instead.

Sexist or Biased Language	Inclusive Term
Businessman	business owner, business executive, or business person
cancer victim; AIDS victim	cancer patient; person living with AIDS
chairman	chairperson or chair
confined to a wheelchair	uses a wheelchair
congressman	congressperson
Eskimo	Inuit or Aleut
fireman	firefighters
freshman	first-year student
Indian (when referring to U.S. indigenous peoples)	Native American or specific tribe
policeman	police officer
man or mankind	people, humanity, or the human race
man hours	working hours
man-made	manufactured, machine made, or synthetic
manpower	personnel or workforce

Negro or colored	African American or Black
old people or elderly	senior citizens, mature adults, older adults
Oriental	Asian, Asian American, or specific country of origin
postman or mailman	postal worker or mail carrier
steward or stewardess	flight attendant
suffers from diabetes	has diabetes; person living with diabetes
to man	to operate; to staff; to cover
waiter or waitress	server

Table 13.2. Replacing Sexist or Biased Language with Inclusive Terms

MINDFULNESS ACTIVITY



We live in a world where respect and bias are not always acknowledged in the workplace setting. Sadly, despite decades of anti-discrimination legislation and training, we know this is still a problem. Women, minorities, and other non-dominant groups are still woefully underrepresented in a broad range of organizational positions, from management to CEO. Some industries are better than others, but this problem is still very persistent in the United States. Most of us mindlessly participate in these systems without even being consciously aware. Byron Lee puts it this way:

Our brains rapidly categorize people using both obvious and subtler characteristics, and also automatically assign an unconscious evaluation (eg good or bad) and an emotional tone (ie pleasant, neutral or unpleasant) with this memory. Importantly, because these unconscious processes happen without awareness, control, intention or effort, everyone, no matter how fair-minded we might think we are, is unconsciously biased.⁵

These unconscious biases often lead us to engage in microaggressions against people we view as “other.” Microaggressions are “the everyday verbal, nonverbal, and environmental slights, snubs, or insults, whether intentional or unintentional, which communicate hostile, derogatory, or negative messages to target persons based solely upon their marginalized group membership.”⁶ Notice that microaggressions can be targeted at women, minorities, and other non-dominant groups. Research has shown us that these unconscious biases effect everything from perceptions of hireability, to job promotions, to determining who gets laid off, and so many other areas within the workplace.

Byron Lee has devised a five-point strategy for engaging in mindful intercultural interactions:

1. Preparing for your interpersonal encounter by recognizing and gently observing preconceptions, biases, emotions, and sensations as part of your ongoing internal experience (Nonjudging). Bringing into awareness an intention to connect (Presence).
2. Beginning your conversation by remaining open to hear whatever the person may bring (Acceptance), and a willingness to get close to and understand another’s suffering (Empathic Concern).
3. Bringing a kindly curiosity to your own internal experience and to the experiences shared by the other person throughout the encounter (Beginner’s Mind).

4. Noticing and letting go of your urge to “fix” the “problem” (Non-striving) and letting the process unfold in its own time (Patience).
5. The collaborative interaction concludes when you mutually reach a way forward that reflects the other person’s world view and needs (Compassionate Action), and not your own (Letting Go).⁷

For this activity, we want you to explore some of your own unconscious biases. To start, go to the Implicit Association Test (IAT) website run by [Project Implicit](#). On their website, you’ll find several tests that examine your unconscious or implicit biases towards various groups. Complete a couple of these tests and then ponder what your results say about your own unconscious biases. After completing the tests, answer the following questions:

1. Were you surprised by your scores on the IATs? Why?
2. How do you think your own implicit biases impact how you interact with others interpersonally?
3. How can you be more mindful of your interactions with people from different groups in the future?

Personal Responsibility

Let’s face it; we all make mistakes. Making mistakes is a part of life. **Personal responsibility** refers to an individual’s willingness to be accountable for what they feel, think, and behave. Whether we’re talking about our attitudes, our thought processes, or physical and communicative behaviors, personal responsibility is simply realizing that we are in the driver’s seat and not blaming others for our current circumstances. Now, this is not to say that there are never external factors that impede our success. Of course, there are. This is not to say that certain people have advantages in life because of a privileged background; of course, some people have. However, personal responsibility involves differentiating between those things we can control and those things that are outside of our control. For example, I may not be able to control a coworker who decides to yell at me, but I can control how I feel about that coworker, how I think about that coworker, and how I choose to respond to that coworker. Here are some ways that you can take personal responsibility in your own life (or in the workplace):

- Acknowledge that you are responsible for your choices in the workplace.
- Acknowledge that you are responsible for how you feel at work.
- Acknowledge that you are responsible for your behaviors at work.
- Accept that your choices are yours alone, so you can’t blame someone else for them.
- Accept that your sense of self-efficacy and self-esteem are yours.
- Accept that you can control your stress and feelings of burnout.
- Decide to invest in your self-improvement.
- Decide to take control of your attitudes, thoughts, and behaviors.
- Decide on specific professional goals and make an effort and commitment to accomplish those goals.

Although you may have the ability to take responsibility for your feelings, thoughts, and behaviors, not everyone in the workplace will do the same. Most of us will come in contact with coworkers who do not take personal responsibility. Dealing with coworkers who have a million and one excuses can be frustrating and demoralizing.

Excuse-making occurs any time an individual attempts to shift the blame for an individual’s behavior

from reasons more central to the individual to sources outside of their control in the attempt to make themselves look better and more in control.⁸ For example, an individual may explain their tardiness to work by talking about how horrible the traffic was on the way to work instead of admitting that they slept in late and left the house late. People make excuses because they fear that revealing the truth would make them look bad or out of control. In this example, waking up late and leaving the house late is the fault of the individual, but they blame the traffic to make themselves look better and in control even though they were late.

Excuse-making happens in every facet of life, but excuse-making in the corporate world can be highly problematic. For example, research has shown that when front-line service providers engage in excuse-making, they are more likely to lose return customers as a result.⁹ In one study, when salespeople attempted to excuse their lack of ethical judgment by pointing to their customers' lack of ethics, supervisors tended to punish more severely those who engaged in excuse-making than those who had not.¹⁰ Of course, even an individual's peers can become a little annoyed (or downright disgusted) by a colleague who always has a handy excuse for their behavior. For this reason, Amy Nordrum recommends using the **ERROR** method when handling a situation where your behavior was problematic: Empathy, Responsibility, Reason, Offer Reassurance.¹¹ Here is an example Nordrum uses to illustrate the **ERROR** method:

I hate that you [burden placed on person] because of me (Empathy). I should have thought things out better (Responsibility), but I got caught up in [reason for behavior] (Reason). Next time I'll [preventative action] (Offer Reassurance).

As you can see, the critical parts of this response involve validating the other person, taking responsibility, and providing an explanation for how you'll behave in the future to avoid similar problems.

Language Use

In the workplace, the type of language and how we use language is essential. In a 2016 study conducted by PayScale,¹² researchers surveyed 63,924 managers. According to these managers, the top three hard skills that new college graduates lack are writing proficiency (44%), public speaking (39%), and data analysis (36%). The top three soft skills new college graduates lack are critical thinking/problem-solving (60%), attention to detail (56%), and communication (46%). One of the most important factors of professionalism in today's workplace is effective written and oral communication. From the moment someone sends in a resume with a cover letter, their language skills are being evaluated, so knowing how to use both formal language and jargon or specialized language effectively is paramount for success in the workplace.

Formal Language

Formal language is a specific writing and spoken style that adheres to strict conventions of grammar. This is in contrast to informal language, which is more common when we speak. In the workplace, there are reasons why someone would use both formal and informal language. Table 13.3 provides examples of formal and informal language choices.

Characteristic	Informal	Formal
Contraction	I <i>won't</i> be attending the meeting on Friday.	I <i>will not</i> be attending the meeting on Friday.
Phrasal Verbs	The report <i>spelled out</i> the need for more resources.	The report <i>illustrated</i> the need for more resources.
Slang/ Colloquialism	The <i>nosedive</i> in our quarterly earnings <i>came out of left field</i> .	The <i>downturn</i> in our quarterly earnings <i>was unexpected</i> .
First-Person Pro-nouns	<i>I considered</i> numerous research methods before deciding to use an employee satisfaction survey.	<i>Numerous research methods were considered</i> before deciding to use an employee satisfaction survey.
	<i>We</i> need to come together to complete the organization's goals.	<i>The people within the organization</i> must work towards the organization's goals.

Table 13.3 Formal and Informal Language Choices

As you can see from Table 13.3, formal language is less personal and more professional in tone than informal language. Some key factors of formal language include complex sentences, use of full words, and the third person. **Informal language**, on the other hand, is more colloquial or common in tone; it contains simple, direct sentences; uses contractions and abbreviations, and allows for a more personal approach that includes emotional displays. For people entering the workplace, learning how to navigate both formal and informal language is very beneficial because different circumstances will call for both in the workplace. If you're writing a major report for shareholders, then knowing how to use formal language is very important. On the other hand, if you're a PR professional speaking on behalf of an organization, speaking to the media using formal language could make you (and your organization) look distant and disconnected, so using informal language might help in this case.

Use of Jargon and Specialized Language

Every industry is going to be filled with specialized **jargon**, or the specialized or technical language particular to a specific profession, occupation, or group that is either meaningless to outsiders or difficult for them to understand. For example, if I informed you that we conducted a "factor analysis with a varimax rotation," most of your heads would immediately start to spin. However, those of us who study human communication from a quantitative or statistical perspective, we know what that phrase means because we learned it during our training in graduate school. If you walked into a hospital and heard an Emergency Department (ED) physician referring to the GOMER in bay 9, most of you would be equally perplexed. Every job has some jargon, so part of being a professional is learning the jargon within your industry and peripherally related sectors as well. For example, if you want to be a pharmaceutical sales representative, learning some of the jargon of an ED (notice they're not called Emergency Rooms [ERs] anymore). Trust us, watching the old television show ER isn't going to help you learn this jargon very well either.¹³

Instead, you have to spend time within an organization or field to pick up the necessary jargon. However, you can start this process as an undergraduate by joining student groups associated with specific fields. If you want to learn the jargon of public relations, join the Public Relations Student

Society of America. If you want to go into training and development, becoming a student member of the Association for Talent Development. Want to go into nonprofit work, become a member of the Association for Volunteer Administration or the Young Nonprofit Professionals Network. If you do not have a student chapter of one of these groups on your campus, then find a group on LinkedIn or another social networking site aimed at professionals. One of the great things about modern social networking is the ability to watch professionals engaging in professional dialogue virtually. By watching the discussions in LinkedIn groups, you can start to pick up on the major issues of a field and some of the everyday jargon.

Key Takeaways

- A profession is an occupation that involves mastery of complex knowledge and skills through prolonged training, education, or practical experience. Professionalism, on the other hand, involves the aims and behaviors that demonstrate an individual's level of competence expected by a professional within a given profession.
- The term ethics is defined as the judgmental attachment to whether something is good, right, or just. In our society, there have been several notable ethical lapses, including those by such companies as United Airlines, Facebook, Equifax, and the Environmental Protection Agency. Starting in fall 2017, the #MeToo movement started shining a light on a wide range of ethical issues involving the abuse of one's power to achieve sexual desires in the entertainment industry. This movement has raised awareness and legal action against a broad range of individuals who had previously gotten away with the illegal behavior in the workplace.
- Respecting our coworkers is one of the most essential keys to developing a positive organizational experience. There are many simple things we can do to show our respect, but one crucial feature is thinking about the types of language we use. Avoid using language that is considered biased and marginalizing.
- Personal responsibility refers to an individual's willingness to be accountable for what they feel, think, and behave. Part of being a successful coworker is taking responsibility for your behaviors, communication, and task achievement in the workplace.
- Formal language is a specific writing and spoken style that adheres to strict conventions of grammar. Conversely, informal language is more colloquial or common in tone; it contains simple, direct sentences; uses contractions and abbreviations, and allows for a more personal approach that includes emotional displays.

Exercises

- Think of a time in an organization where you witnessed unethical organizational communication. Which components of Redding's typology did you witness? Did you do anything about the unethical organizational communication? Why?
- Look at the list of respectful behaviors for workplace interactions. How would you react if others violated these respectful behaviors towards you as a coworker?

- Have you ever been disrespectful in your communication towards coworkers? Why?
- Why do you think it's essential to take personal responsibility and avoid excusing making in the workplace? Have you ever found yourself making excuses? Why?

13.2 Leader-Follower Relationships

LEARNING OUTCOMES

1. Visual and explain Hersey and Blanchard's situational-leadership theory, including the four types of leaders.
2. Describe the concept of leader-member exchange theory and the three stages these relationships go through.
3. Define Ira Chaleff's concept of followership and describe the four different followership styles.

Perspectives on Leadership

When you hear the word “leader” what immediately comes to your mind? What about when you hear the word “follower?” The words “leader” and “follower” bring up all kinds of images (both good and bad) for most of us. We've all experienced times when we've followed a fantastic leader, and we've had times when we've worked for a less than an effective leader. At the same time, are we always the best followers? This section is going to examine prevailing theories related to leadership (situational-leadership theory and leader-member exchange theory), and then we'll end the section discussing the concept of followership.

Hersey and Blanchard's Situational-Leadership Theory

One of the most commonly discussed models of leadership is Paul Hersey and Kenneth Blanchard Situational Leadership Model (<https://www.situational.com/>). The model is divided into two dimensions: task (leader directive behavior) and relational (leader supportive behavior).¹⁴ Hersey and Blanchard's situational leadership model starts with the basic idea that not all employees have the same needs. Some employees need a lot more hand-holding and guidance than others, and some employees need more relational contact than others. As such, Hersey and Blanchard define leadership along two continuums: supportive and directive. **Supportive leadership behavior** occurs when a leader is focused on providing relational support for their followers, whereas **directive support** involves overseeing the day-to-day tasks that a follower accomplishes. As a leader and a follower progress in their relationship, Hersey and Blanchard argue that the nature of their relationship often changes. Figure 13.2 contains the basic model proposed by Hersey and Blanchard and is broken into four leadership styles: directing, coaching, supporting, and delegating.¹⁵

Directing

Hersey and Blanchard's first type of leader is the directing leader. Directing leaders set the basic roles an individual has and the tasks an individual needs to accomplish. After setting these roles and tasks,

the leader then monitors and oversees their followers closely. From a communication perspective, these leaders usually to make decisions and then communicate them to their followers. There tends to be little to no dialogue about either roles or tasks.

Coaching

Hersey and Blanchard's second type of leader is the coaching leader. Coaching leaders still set the basic roles and tasks that need to be accomplished by specific followers, but they allow for input from their followers. As such, the communication between coaching leaders and their followers tends to be more interactive instead of one-way. However, decisions about roles and tasks still ultimately belong to the leader.

Supporting

Hersey and Blanchard's third type of leader is the supporting leader. As a leader becomes more accustomed to a follower's ability to accomplish tasks and take responsibility for those tasks, a leader may become more supportive. A supporting leader allows followers to make the day-to-day decisions related to getting tasks accomplished, but determining what tasks need to be accomplished is a mutually agreed upon decision. In this case, the leader facilitates rather than dictates the follower's work.

Delegating

Hersey and Blanchard's final type of leader is the delegating leader. The delegating leader and their follower are mutually involved in the basic decision making and problem-solving processes. Still, the ultimate control for accomplishing tasks is left up to the follower. Followers ultimately determine when they need a leader's support and how much support is needed. As you can see from Figure 13.2, these relationships are ones that are considered highly developed and ultimately involve a level of trust on both sides of the leader-follower relationship.

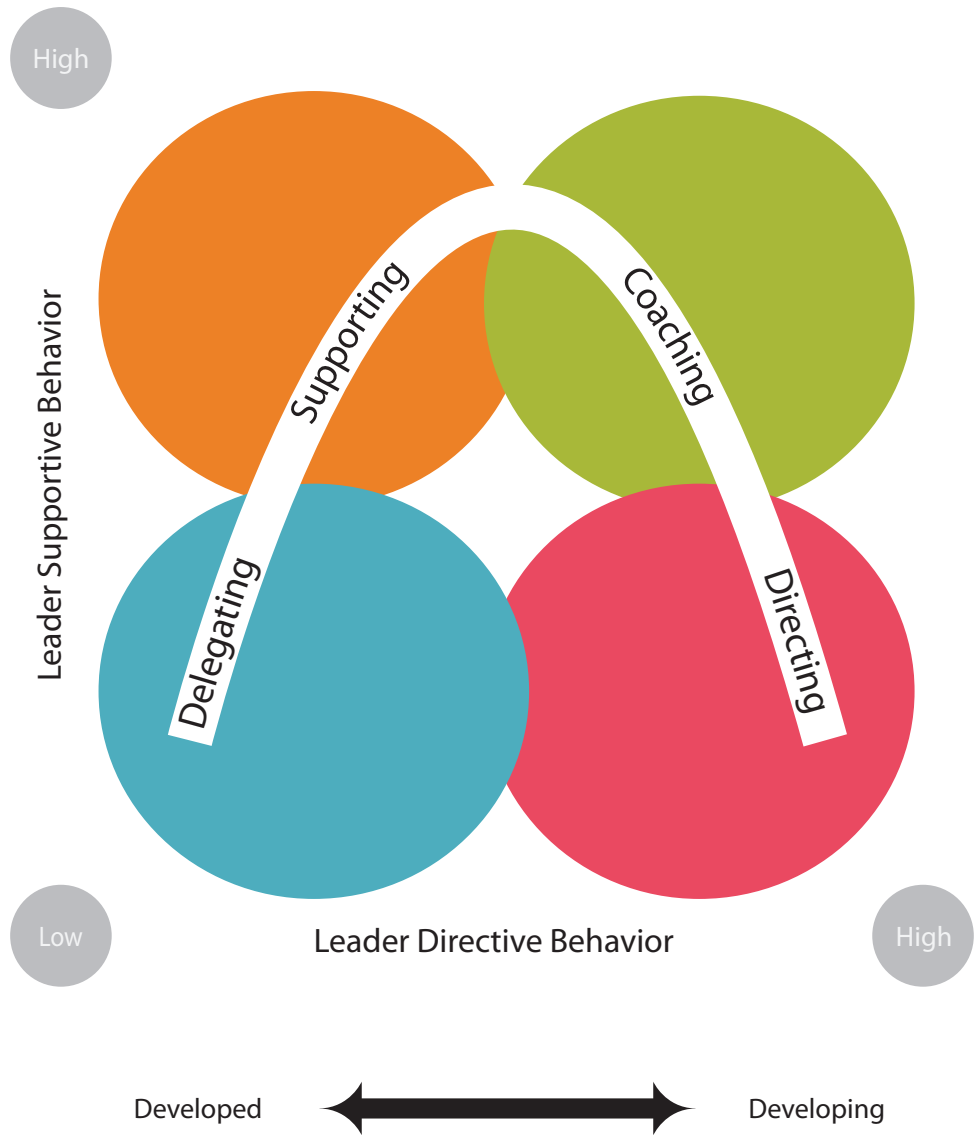

Figure 13. 2 Situational Leadership

Leader-Member Exchange Relationships

Fred Dansereau, George Graen, and William J. Haga proposed a different type of theory for understanding leadership.¹⁶ In **leader-member exchange (LMX)** theory, leaders have limited resources and can only take on high-quality relationships with a small number of followers.¹⁷ For this reason, some relationships are characterized as high-quality LMX relationships, but most are low-quality LMX relationships. High-quality LMX relationships are those “characterized by greater input in decisions, mutual support, informal influence, trust, and greater negotiating latitude.”¹⁸

In contrast, low-quality LMX relationships “are characterized by less support, more formal supervision, little or no involvement in decisions, and less trust and attention from the leader.”¹⁹ Ultimately, many positive outcomes happen for a follower who enters into a high LMX relationship with a leader. Before looking at some positive outcomes from high LMX relationships, we’re first going to examine the stages involved in the creation of these relationships.

Stages of LMX Relationships

So, you may be wondering how LMX relationships are developed. George B. Graen and Mary Uhl-Bien created a three-stage model for the development of LMX relationships.²⁰ Figure 13.3 represents the three different stages discussed by Graen and Uhl-Bien: stranger, acquaintance, and partner.

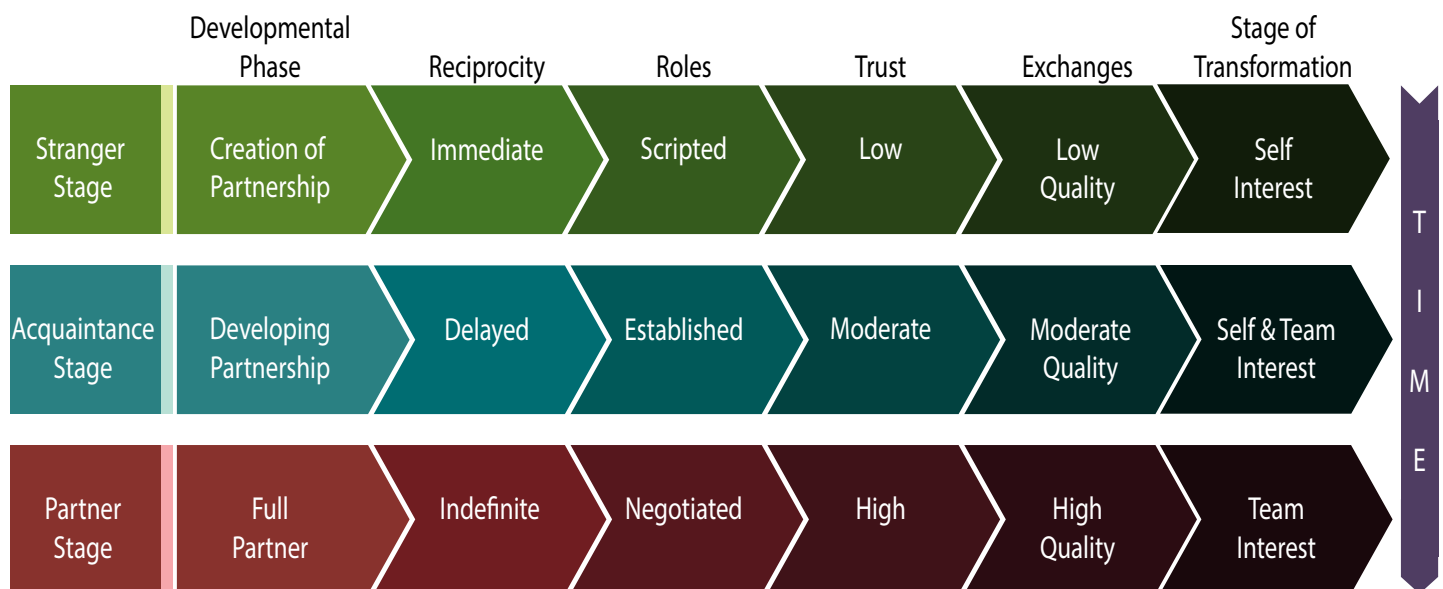

Figure 13.3 Stages of LMX Relationships

Stranger Stage

The first stage of LMX relationships is the stranger stage, and this is the beginning of the creation of an LMX relationship. Most LMX relationships never venture beyond the stranger stage because of the resources needed on both the side of the follower and the leader to progress further.

As you can see from Figure 13.3, the stranger stage is one where self-interest primarily guides the follower and the leader. These exchanges generally involve what Graen and Uhl-Bien call a “cash-and-carry” relationship. Cash-and-carry refers to the idea that some stores don’t utilize credit, so all purchases are made in cash, and customers carry their goods out of the store at the moment of purchase. In the stranger stage, interactions between a follower and leader follow this same process. The leader helps the follower and gets something immediately in return. Low levels of trust mark these relationships,

and interactions tend to be carried out through scripted forms of communication within the normal hierarchical structure of the organization.

Acquaintance Stage

The second stage of high-quality LMX relationships is the acquaintance stage, when exchanges between a leader and follower become more normalized and aren't necessarily based on a cash-and-carry system. According to Graen and Uhl-Bien, "Leaders and followers may begin to share greater information and resources, on both a personal and a work level. These exchanges are still limited, however, and constitute a 'testing' stage—with the equitable return of favors within a limited time perspective."²¹ At this point, neither the leader nor the follower expects to get anything immediately in return within the exchange relationship. Instead, they start seeing this relationship as something that has the potential for long-term benefits for both sides. There also is a switch from purely personal self-interest to a combination of both self-interests and the interests of one's team or organization.

Partner Stage

The final stage in the development of LMX relationships is the partner stage, or the stage where a follower stops being perceived as a follower and starts being perceived as an equal or colleague. A level of maturity marks these relationships. Even though the two people within the exchange relationship may still have titles of leader and follower, there is a sense of equality between the individuals within the relationship.

Outcomes of High LMX Relationships

Ultimately, high LMX relationships take time to develop, and most people will not enter into a high LMX relationship within their lifetime. These are special relationships but can have a wildly powerful impact on someone's career and life. The following are some of the known outcomes of high LMX relationships when compared to those in low LMX relationships:

1. Increased productivity (both quality and quantity).
2. Increased job satisfaction.
3. Decreased likelihood of quitting.
4. Increased supervisor satisfaction.
5. Increased organizational commitment.
6. Increased satisfaction with the communication practices of the team and organization.
7. Increased clarity about one's role in the organization.
8. Increased likelihood to go beyond their job duties to help other employees.
9. Higher levels of success in their careers.
10. Increased likelihood of providing honest feedback.
11. Increased motivation at work.
12. Higher levels of influence within their organization.
13. Receive more desirable work assignments.
14. Higher levels of attention and support from organizational leaders.
15. Increased organizational participation.^{22, 23, 24, 25}

Research Spotlight



In a 2019 article, Leah Omilion-Hodges, Scott Shank, and Christine Packard wanted to find out what young adults want in a manager. To start, the researchers orally interviewed 22 undergraduate students whose mean age was 22. They asked the students about the general desires they have for managers, which included questions about general management style and communication (frequency and quality). Previous research by Omilion-Hodges and Christine Sugg had determined five management archetypes, which were reaffirmed in the current study:²⁶

1. Mentor: An empathetic advocate, professional, and personal guide.
2. Manager: A proxy for organizational leadership who takes a transactional approach to leader-follower relationships.
3. Teacher: Seen as a traditional educator who provides role testing episodes, clear feedback, and opportunities for redemption and growth.
4. Friend: Although in a managerial position, perceived as an informed and approachable peer.
5. Gatekeeper: A high-status actor who is positioned to either advocate for or against an employee.²⁷
 - a. In the current set of focus group interviews, the researchers focused more on the communicative and relational behaviors students wanted out of managers:
 - b. Mentor: Role model, leader by example, advocate, life coach, and someone who makes and leaves an impact.
 - c. Manager: Is the nuts and bolts of a functional organization, lacks a personal relationship with followers, monitors and delegates tasks, maintains the establishment, is structured and organized, sticks to the plan, follows rules and regulations, is strictly business, observes hierarchy and protocol, and is proficient in their day-to-day task accomplishment.
 - d. Teacher: Provides learning opportunities; supportive; dedicated to growth of the organization, delegates information, provides necessary resources, explicit directions, feedback, and one-on-one instruction.
 - e. Friend: Has a well-developed relationship with followers outside of work, is empathetic; supports followers in all areas of their lives including identity development, is seen as similar by followers, values employees as whole people (not just as workers), relationally focused.
 - f. Gatekeeper: Is removed from day-to-day operations, strategic, can help you advance or hold you back, abides rules and regulation, restricts information at their discretion, communicates only to influence, controls the successes and or failures of followers.²⁸

With the focus groups completed, the researchers used what they learned to create a 54-item measure of management archetypes, which they then tested with a sample of 153 participants. During the analysis process, the researchers lost the gatekeeper set of questions, but the other four management archetypes held firm. This study was confirmed in a third study using 249 students.

Omilion-Hodges, L. M., Shank, S. E., & Packard, C. M. (2019). What young adults want: A multistudy examination of vocational anticipatory socialization through the lens of students' desired managerial communication behaviors. *Management Communication Quarterly*, 33(4), 512-547. <https://doi.org/10.1177/0893318919851177>

Followership

Although there is a great deal of leadership about the concepts of leadership, there isn't as much about people who follow those leaders. **Followership** is "the act or condition under which an individual helps or supports a leader in the accomplishment of organizational goals."²⁹

Ira Chaleff (<http://www.courageousfollower.net/>) was one of the first researchers to examine the nature of followership in his book, *The Courageous Follower*.³⁰ Chaleff believes that followership is not something that happens naturally for a lot of people, so it is something that people must be willing to engage in. From this perspective, followership is not a passive behavior. Ultimately, followership can be broken down into two primary factors: the courage to support the leader and the courage to challenge the leader's behavior and policies. Figure 13.4 represents the general breakdown of Chaleff's four types of followers: resource, individualist, implementer, and partner. Before proceeding, you may want to watch the video Chaleff produced that uses tango to illustrate his basic ideas of followership (<https://youtu.be/Cswrnc1dggg>).

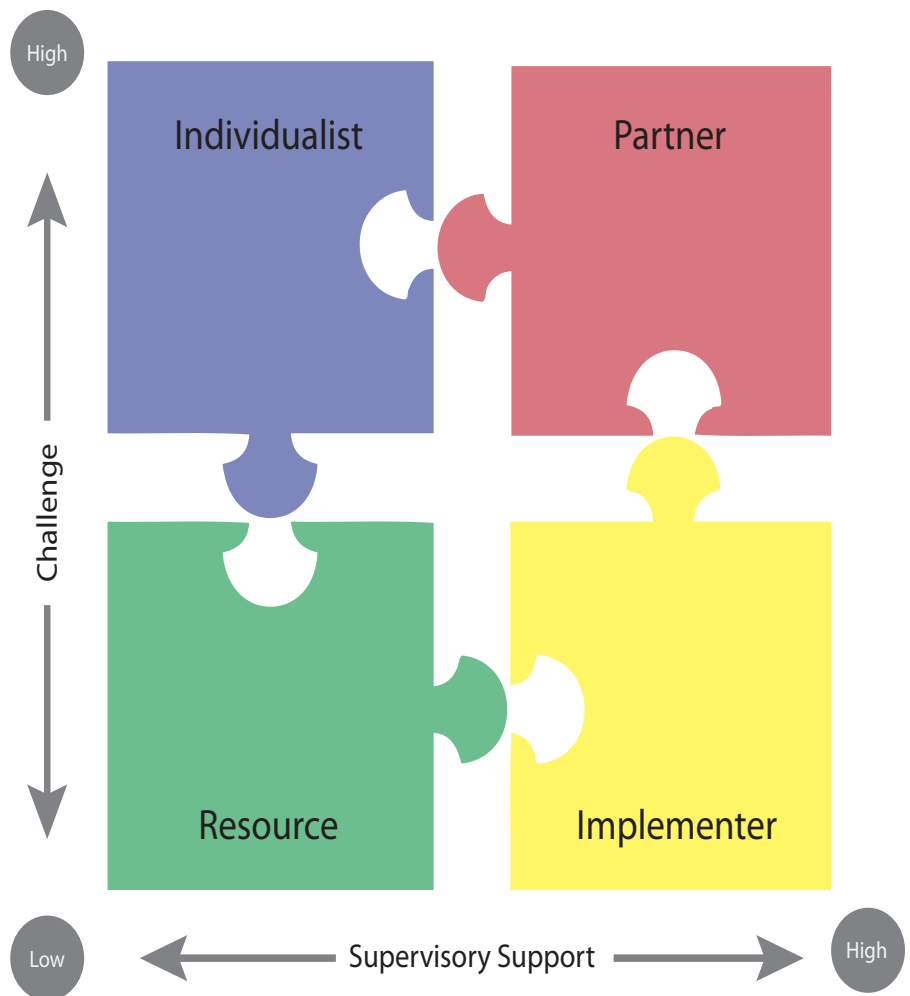

Figure 13.4 4 Styles of Followership

Resource

The first follower style discussed by Chaleff is the resource. Resources will not challenge or support their leader. Chaleff argues that resources generally lack the intellect, imagination, and courage to do more than what is asked of them.

Individualist

The second followership style is the individualist. Individualists tend to do what they think is best in the organization, but not necessarily what they've been asked to do. It's not that individualists are inherently bad followers; they have their perspectives on how things should get accomplished and are more likely to follow their perspectives than those of their leaders. Individualists provide little support for their leaders, and they are the first to speak out with new ideas that contradict their leader's ideas.

Implementer

The third followership style is the implementer. Implementers are very important for organizations because they tend to do the bulk of the day-to-day work that needs to be accomplished. Implementers busy themselves performing tasks and getting things done, but they do not question or challenge their leaders.

Partner

The final type of followership is the partner. Partners have an inherent need to be seen as equal to their leaders with regard to both intellect and skill levels. Partners take responsibility for their own and their leader's ideas and behaviors. Partners do support their leaders but have no problem challenging their leaders. When they do disagree with their leaders, partners point out specific concerns with their leader's ideas and behaviors.

Key Takeaways

- Hersey and Blanchard's situational-leadership theory can be seen in Figure 13.2. As part of this theory, Hersey and Blanchard noted four different types of leaders: directing, coaching, supporting, and delegating. Directing leaders set the basic roles an individual has and the tasks an individual needs to accomplish. Coaching leaders still set the basic roles and tasks that need to be accomplished by specific followers, but they allow for input from their followers. Supporting leader allows followers to make the day-to-day decisions related to getting tasks accomplished, but determining what tasks need to be accomplished is a mutually agreed upon decision. And a delegating leader is one where the follower and leader are mutually involved in the basic decision-making and problem-solving process, but the ultimate control for accomplishing tasks is left up to the follower.
- Leader-member exchange theory (LMX) explores how leaders enter into two-way relationships with followers through a series of exchange agreements enabling followers to grow or be held back. There are three stages of LMX relationships: stranger, acquaintance, and partner. The stranger stage is one where their self-interests primarily guide the follower and the leader. In the acquaintance stage, exchanges between a leader and follower become more normalized and aren't necessarily based on a cash-and-carry system. Finally, the partner stage is when a follower stops being perceived as a follower and starts being perceived as an equal or colleague.
- Followership is the act or condition under which an individual helps or supports a leader in the accomplishment of organizational goals. In Ira Chaleff's concept of followership, he describes four different followership styles: resource, individualist, implementer, and partner. First, a resource is someone who will not support or challenge their leader. Second, an individualist is someone who engages in low levels of supervisory support but high levels of challenge for a leader. Third, implementers support their leaders but don't challenge them, but they are known for doing the bulk of the day-to-day work. Lastly, partners are people who show both high levels of support and challenge for their leaders. Partners have an inherent need to be seen as equal to their leaders with regard to both intellect and

skill levels.

Exercises

- Think back to one of your most recent leaders. If you were to compare their leadership style to Hersey and Blanchard's situational-leadership theory, which of the four leadership styles did this leader use with you? Why do you think this leader used this specific style with you? Did this leader use different leadership styles with different followers?
- Why do you think high LMX relationships are so valuable to one's career trajectory? Why do you think more followers or leaders go out of their ways to develop high LMX relationships?
- When thinking about your relationship with a recent leader, what type of follower were you according to Ira Chaleff's concept of followership? Why?

13.3 Coworker (Peer Relationships)

LEARNING OUTCOMES

1. List and explain Patricia Sias's characteristics of coworker relationships and Jessica Methot's three additional characteristics.
2. Differentiate among Kathy Kram and Lynn Isabella's three types of coworker relationships.
3. Explain Patricia Sias and Daniel Cahill's list of influencing factors on coworker relationships.
4. Describe the three ways coworkers go about disengaging from workplace relationships articulated by Patricia Sias and Tarra Perry.

Characteristics of Coworker Relationships

According to organizational workplace relationship expert Patricia Sias, peer coworker relationships exist between individuals who exist at the same level within an organizational hierarchy and have no formal authority over each other.³¹ According to Sias, we engage in these coworker relationships because they provide us with mentoring, information, power, and support. Let's look at all four of these.

Sias's Reasons for Workplace Relationships

Mentoring

First, our coworker relationships are a great source for mentoring within any organizational environment.

It's always good to have a peer that you can run to when you have a question or need advice. Because this person has no direct authority over you, you can informally interact with this person without fear of reproach if these relationships are healthy. We'll discuss what happens when you have nonhealthy relationships in the next section.

Sources of Information

Second, we use our peer coworker relationships as sources of information. One of our coauthors worked in a medical school for a while. Our coauthor quickly realized that there were some people he could talk to around the hospital who would gladly let him know everything that was going on around the place. One important caveat to all of this involves the quality of the information we are receiving. By information quality, Sias refers to the degree to which an individual perceives the information they are receiving as accurate, timely, and useful. Ever had that one friend who always has great news, that everyone else heard the previous week? Not all information sources provide you with quality information. As such, we need to establish a network of high-quality information sources if we are going to be successful within an organizational environment.

Issues of Power

Third, we engage in coworker relationships as an issue of power. Although two coworkers may exist in the same run within an organizational hierarchy, it's important also to realize that there are informal sources of power as well. In the next chapter, we are going to explore the importance of power within interpersonal relationships in general. For now, we'll say that power can help us influence what goes on within our immediate environments. However, power can also be used to control and intimidate people, which is a huge problem in many organizations.

Social Support

The fourth reason we engage in peer coworker relationships is social support. For our purposes, let's define **social support** as the perception and actuality that an individual receives assistance and care from those people within their life. Let's face it; there's a reason corporate America has been referred to as a concrete jungle, a circus, or a theatre of the absurd. Even the best organization in the world can be trying at times. The best boss in the world will eventually get under your skin about something. We're humans; we're flawed. As such, no organization is perfect, so it's always important to have those peer coworkers we can go to who are there for us. One of our coauthors has a coworker who they call whenever our coauthor needs to be "talked off the ledge." Our coauthor likes higher education and loves being a professor, but occasionally something happens, and our coauthor needs to vent to about something that has occurred. For the most part, our coauthor doesn't want their coworker to solve a problem; our coauthor just wants someone to listen. We all need to de-stress in the workplace, and having peer coworker relationships is one way we do this.

Other Characteristics

In addition to the four characteristics discussed by Sias, Jessica Methot argue that three other features are also important: trust, relational maintenance, and ability to focus.³²

Trust

Methot defines trust as “the willingness to be vulnerable to another party with the expectation that the other party will behave with the best interest of the focal individual.”³³ In essence, in the workplace, we eventually learn how to make ourselves vulnerable to our coworkers believing that our coworkers will do what’s in our best interests. Now, trust is an interesting and problematic concept because it’s both a function of workplace relationships and also an outcome. For coworker relationships to work or operate as they should, we need to be able to trust our coworkers. However, the more we get to know our coworkers and know they have our best interests at heart, then the more we will ultimately trust our coworkers. Trust develops over time and is not something that is not just a binary concept (trust or no trust). Instead, there are various degrees of trust in the workplace. At first, you may trust your coworkers just enough to tell them surface level things about yourself (e.g., where you went to college, your major, your hometown), but over time, as we’ve discussed before in this book, we start to self-disclose as deeper levels as our trust increases. Most coworker relationships will never be intimate relationships or even actual friendships, but we can learn to trust our coworkers within the confines of our jobs.

Relational Maintenance

Kathryn Dindia and Daniel J. Canary write that definitions of the term “relational maintenance” can be broken down into four basic types:

- 1 . To keep a relationship in existence;
- 2 . To keep a relationship in a specified state or condition;
- 3 . To keep a relationship in a satisfactory condition; and
- 4 . To keep a relationship in repair.³⁴

Methot argues that **relational maintenance** is a difficult task in any context. Still, coworker relationships can have a range of negative outcomes if organizational members have difficulty maintaining their relationships with each other. For this reason, Methot defines maintenance difficulty as “the degree of difficulty individuals experience in interpersonal relationships due to misunderstandings, incompatibility of goals, and the time and effort necessary to cope with disagreements.”³⁵ Imagine you have two coworkers who tend to behave in an inappropriate fashion nonverbally. Maybe one coworker sits there and rolls his eyes at everything his coworker says, or perhaps she uses exaggerated facial expressions to mock her coworker when he’s talking. Having these types of coworkers will cause us (as a third party witnessing these problems) to spend more time trying to maintain relationships with both of them. On the flip side, the relationship between our two coworkers will take even more maintenance to get them to a point where they can just be collegial in the same room with each other. The more time we have to spend trying to decrease tension or resolve interpersonal conflicts in the workplace, the less time we will ultimately have on our actual jobs. Eventually, this can leave you feeling exhausted feeling and emotionally drained as though you just don’t have anything else to give. When this happens, we call this having inadequate resources to meet work demands. All of us will eventually hit a wall when it comes to our psychological and emotional resources. When we do hit that wall, our ability to perform job tasks will decrease. As such, it’s essential that we strive not only to maintain healthy relationships with our coworkers ourselves, but also to foster an environment that encourages our coworkers to maintain healthy relationships with each other. However, it’s important to note that some people will simply never play well in the sandbox with others. Some coworker relationships can become so toxic that minimizing contact and interaction can be the best solution to avoid draining your psychological and emotional resources.

Ability to Focus

Have you ever found your mind wandering while you are trying to work? One of the most important things when it comes to getting our work done is having the ability to focus. Within an organizational context, Methot defines “ability to focus” as “the ability to pay attention to value-producing activities without being concerned with extraneous issues such as off-task thoughts or distractions.”³⁶ When individuals have healthy relationships with their coworkers, they are more easily able to focus their attention on the work at hand. On the other hand, if your coworkers always play politics, stab each other in the back, gossip, and engage in numerous other counterproductive workplace (or deviant workplace) behaviors, then it’s going to be a lot harder for you to focus on your job.

Types of Coworker Relationships



Figure 13.5 Types of Coworker Relationships

Now that we’ve looked at some of the characteristics of coworker relationships, let’s talk about the three different types of coworkers that research has categorized. Kathy Kram and Lynn Isabella found that there are essentially three different types of coworker relationships in the workplace: information peer, collegial peer, and special peer.³⁷ Figure 13.5 illustrates the basic things we get from each of these different types of peer relationships.

Information Peers

Information peers are so-called because we rely on these individuals for information about job tasks and the organization itself. As you can see from Figure 13.5, we engage information peers in four basic types of activities we engage information peers for information sharing, workplace socialization and onboarding, networking, and knowledge management and maintenance.

Information Sharing

First, we share information with our information peers. Of course, this information is task-focused, so the information is designed to help us complete our job better.

Workplace Socialization and Onboarding

Second, information peers are vital during workplace socialization or onboarding. **Workplace socialization** can be defined as the process by which new organizational members learn the rules (e.g., explicit policies and explicit procedures), norms (e.g., when you go on break, how to act at work, who to eat with, who not to eat with), and culture (e.g., innovation, risk-taking, team orientation, competitiveness) of an organization. Organizations often have a very formal process for workplace socialization that is called onboarding. Onboarding is when an organization helps new members get acquainted with the organization, its members, its customers, and its products/services.

Networking

Third, information peers help us network within our organization or a larger field. Half of being successful in any organization involves getting to know the key players within the organization. Our information peers will already have existing relationships with these key players, so they can help make introductions. Furthermore, some of our peers may connect with others in the field (outside the organization), so they could help us meet other professionals as well.

Knowledge Management/Maintenance

Lastly, information peers help us manage and maintain knowledge. During the early parts of workplace socialization, our information peers will help us weed through all of the noise and focus on the knowledge that is important for us to do our jobs. As we become more involved in an organization, we can still use these information peers to help us acquire new knowledge or update existing knowledge. When we talk about knowledge, we generally talk about two different types: explicit and tacit. Explicit knowledge is information that is kept in some retrievable format. For example, you'll need to find previously written reports or a list of customers' names and addresses. These are examples of the types of information that may exist physically (or electronically) within the organization. Tacit knowledge, on the other hand, is the knowledge that's difficult to capture permanently (e.g., write down, visualize, or permanently transfer from one person to another) because it's garnered from personal experience and contexts. Informational peers who have been in an organization for a long time will have a lot of tacit knowledge. They may have an unwritten history of why policies and procedures are the way they are now, or they may know how to "read" certain clients because they've spent decades building relationships. For obvious reasons, it's much easier to pass on explicit knowledge than implicit knowledge.

Collegial Peers

The second class of relationships we'll have in the workplace are **collegial peers** or relationships that have moderate levels of trust and self-disclosure and are different from information peers because of the increased openness that is shared between two individuals. Collegial peers may not be your best friends, but they are people that you enjoy working with. Some of the hallmarks of collegial peers include career strategizing, job-related feedback, recognizing competence and performance, and friendship.

Career Strategizing

First, collegial peers help us with career strategizing. **Career strategizing** is the process of creating a plan of action for one's career path and trajectory. First, notice that career strategizing is a process, so it's

marked by gradual changes that help you lead to your ultimate result. Career strategizing isn't something that happens once. Often our intended career paths take twists and turns we never expected or predicted. However, our collegial peers are often great resources for helping us think through this process either within a specific organization or a larger field.

Job-Related Feedback

Second, collegial peers also provide us with job-related feedback. We often turn to those who are around us the most often to see how we are doing within an organization. Our collegial peers can provide us this necessary feedback to ensure we are doing our jobs to the utmost of our abilities and the expectations of the organization. Under this category, the focus is purely on how we are doing our jobs and how we can do our jobs better.

Recognizing Competence and Performance

Third, collegial peers are usually the first to recognize our competence in the workplace and recognize us for excellent performance. Generally speaking, our peers have more interactions with us on the day-to-day job than middle or upper management, so they are often in the best position to recognize our competence in the workplace. Our competence in the workplace can involve having valued attitudes (e.g., liking hard work, having a positive attitude, working in a team), cognitive abilities (e.g., information about a field, technical knowledge, industry-specific knowledge), and skills (e.g., writing, speaking, technical ability) necessary to complete critical work-related tasks. Not only do our peers recognize our attitudes, cognitive abilities, and skills, but they are also there to pat us on the backs and tell us we've done a great job when a task is complete.

Friendship

Lastly, collegial peers provide us a type of friendship in the workplace. They also offer us someone we can both like and trust in the workplace. Now, it's important to distinguish this level of friendships from other types of friendships we have in our lives. Collegial peers are not going to be your "best friends," but they will offer you friendships within the workplace that make work more bearable and even enjoyable. At the collegial level, you may not associate with these friends beyond workplace functions (e.g., sitting next to each other at meetings, having lunch together, finding projects to work on together). It's also possible that a group of collegial peers will go to events outside the workplace as a group (e.g., going to happy hour, throwing a holiday party, attending a baseball game).

Special Peers

The final group of peers we work with are called special peers. Kram and Isabella note that a special peer relationship "involves revealing central ambivalences and personal dilemmas in work and family realms. Pretense and formal roles are replaced by greater self-disclosure and self-expression."³⁸ **Special peer** relationships are marked by confirmation, emotional support, personal feedback, and friendship.

Confirmation

First, special peers provide us with validation. When we are having one of our darkest days at work and are not sure we're doing our jobs well, our special peers are there to let us know that we're doing a good

job. They approve of who we are and what we do. These are also the first people we go to when we do something well at work.

Emotional Support

Second, special peers provide us with emotional support in the workplace. Emotional support from special peers comes from their willingness to listen and offer helpful advice and encouragement. Kelly Zellars and Pamela Perrewé have noted there are four types of emotional social support we get from peers: positive, negative, non-job-related, and empathic communication.³⁹ Positive emotional support is when you and a special peer talk about the positive sides to work. For example, you and a special peer could talk about the joys of working on a specific project. Negative emotional support, on the other hand, is when you and a special peer talk about the downsides to work. For example, maybe both of you talk about the problems working with a specific manager or coworker. The third form of emotional social support is non-job-related or talking about things that are happening in your personal lives outside of the workplace itself. These could be conversations about friends, family members, hobbies, etc. A good deal of the emotional social support we get from special peers has nothing to do with the workplace at all. The final type of emotional social support is empathic communication, or conversations about one's emotions or emotional state in the workplace. If you're having a bad day, you can go to your special peer, and they will reassure you about the feelings you are experiencing. Another example is talking to your special peer after having a bad interaction with a customer that ended with the customer yelling at you for no reason. After the interaction, you seek out your special peer, and they will validate your feelings and thoughts about the interaction.

Personal Feedback

Third, special peers will provide both reliable and candid feedback about you and your work performance. One of the nice things about building an intimate special peer relationship is that both of you will be honest with one another. There are times we need confirmation, but then there are times we need someone to be bluntly honest with us. We are more likely to feel criticized and hurt when blunt honesty comes from someone when we do not have a special peer relationship. Special peer relationships provide a safe space where we can openly listen to feedback even if we're not thrilled to receive that feedback.

Friendship

Lastly, special peers also offer us a sense of deeper friendship in the workplace. You can almost think of special peers as your best friend within the workplace. Most people will only have one or two people they consider a special peer in the workplace. You may be friendly with a lot of your peers (e.g., collegial peers), but a special peer relationship is deeper and more meaningful.

A Further Look at Workplace Friendships

At some point, a peer coworker relationship may, or may not, evolve into a workplace friendship. According to Patricia Sias, there are two key hallmarks of a workplace friendship: voluntariness and personalistic focus. First, workplace friendships are voluntary. Someone can assign you a mentor or a mentee, but that person cannot make you form a friendship with that person. Most of the people you work with will not be your friends. You can have amazing working relationships with your coworkers, but you may only develop a small handful of workplace friendships. Second, workplace friendships have a

personalistic focus. Instead of just viewing this individual as a coworker, we see this person as someone who is a whole individual who is a friend. According to research, workplace friendships are marked by higher levels of intimacy, frankness, and depth than those who are peer coworkers.⁴⁰

Friendship Development in the Workplace

According to Patricia Sias and Daniel Cahill, workplace friendships are developed by a series of influencing factors: individual and personal factors, contextual factors, and communication changes.

⁴¹ First, some friendships develop because we are drawn to the other person. Maybe you're drawn to a person in a meeting because she has a sense of humor that is similar to yours, or maybe you find that another coworker's attitude towards the organization is exactly like yours. Whatever the reason we have, we are often drawn to people that are like us. For this reason, we are often drawn to people who resemble ourselves demographically (e.g., age, sex, race, religion).

A second reason we develop relationships in the workplace is because of a variety of different contextual factors. Maybe your office is right next to someone else's office, so you develop a friendship because you're next to each other all the time. Perhaps you develop friendships because you're on the same committee or put on the same work project with another person. In large organizations, we often end up making friends with people simply because we get to meet them. Depending on the size of your organization, you may end up meeting and interact with a tiny percentage of people, so you're not likely to become friends with everyone in the organization equally. Other organizations provide a culture where friendships are approved of and valued. In the realm of workplace friendship research, two important factors have been noticed concerning contextual factors controlled by the organization: opportunity and prevalence.⁴² Friendship opportunity refers to the degree to which an organization promotes and enables workers to develop friendships within the organization. Does your organization have regular social gatherings for employees? Does your organization promote informal interaction among employees, or does it clamp down on coworker communication? Not surprisingly, individuals who work in organizations that allow for and help friendships tend to be satisfied, more motivated, and generally more committed to the organization itself.

Friendship prevalence, on the other hand, is less of an organizational culture and more the degree to which an individual feels that they have developed or can develop workplace friendships. You may have an organization that attempts to create an environment where people can make friends, but if you don't think you can trust your coworkers, you're not very likely to make workplace friends. Although the opportunity is important when seeing how an individual responds to the organization, friendship prevalence is probably the more important factor of the two. If I'm a highly communicative apprehensive employee, I may not end up making any friends at work, so I may see my workplace place as just a job without any commitment at all. When an individual isn't committed to the workplace, they will probably start looking for another job.⁴³

Lastly, as friendships develop, our communication patterns within those relationships change. For example, when we move from being just an acquaintance to being a friend with a coworker, we are more likely to increase the amount of communication about non-work and personal topics. Sias and Cahill note that change from friend to close friend is marked by decreased caution and increased intimacy. Furthermore, this transition in friendship is characterized by an increase in discussing work-related problems. The final transition from a close friend to "almost best" friend. According to Sias and Cahill, "Because of the increasing amount of trust developed between the coworkers, they felt freer to share opinions and feelings, particularly their feelings about work frustrations. Their discussion about both

work and personal issues became increasingly more detailed and intimate.”⁴⁴

Relationship Disengagement

Thus far, we've talked about workplace friendships as positive factors in the workplace, but any friendship can sour. Some friendships sour because one person moves into a position of authority of the other, so there is no longer perceived equality within the relationship. Other friendships occur when there is a relationship violation of some kind (see Chapter 8). Some friendships devolve because of conflicting expectations of the relationship. Maybe one friend believes that giving him a heads up about insider information in the workplace is part of being a friend, and the other person sees it as a violation of trust given to her by her supervisors. When we have these conflicting ideas about what it means to “be a friend,” we can often see a schism that gets created. So, how does an individual get out of workplace friendships? Patricia Sias and Tarra Perry were the first researchers to discuss how colleagues disengage from relationships with their coworkers.⁴⁵ Sias and Perry found three distinct tools that coworkers use: state-of-the-relationship talk, cost escalation, and depersonalization. Before explaining them, we should mention that people use all three and do not necessarily progress through them in any particular order.

State-of-the-Relationship Talk

The first strategy people use when disengaging from workplace friendships involves state-of-the-relationship talk. **State-of-the-relationship talk** is exactly what it sounds like; you officially have a discussion about the friendship ending. The goal of state-of-the-relationship talk is to engage the other person and inform them that ending the friendship is the best way to ensure that the two can continue a professional, functional relationship. Ideally, all workplace friendships could end in a situation where both parties agree that it's in everyone's best interest for the friendship to stop. Still, we all know this isn't always the case, which is why the other two are often necessary.

Cost Escalation

The second strategy people use when ending a workplace friendship involves cost escalation. **Cost escalation** involves tactics that are designed to make the cost of maintaining the relationship higher than getting out of the relationship. For example, a coworker could start belittling a friend in public, making the friend the center of all jokes, or talking about the friend behind the friend's back. All of these behaviors are designed to make the cost of the relationship too high for the other person.

Depersonalization

The final strategy involves depersonalization. **Depersonalization** can come in one of two basic forms. First, an individual can depersonalize a relationship by stopping all the interaction that is not task-focused. When you have to interact with the workplace friend, you keep the conversation purely business and do not allow for talk related to personal lives. The goal of this type of behavior is to alter the relationship from one of closeness to one of professional distance. The second way people can depersonalize a relationship is simply to avoid that person. If you know a workplace friend is going to be at a staff party, you purposefully don't go. If you see the workplace friend coming down the hallway, you go in the opposite direction or duck inside a room before they can see you. Again, the purpose of this type of depersonalization is to put actual distance between you and the other person. According to Sias and Perry's research, depersonalization tends to be the most commonly used tactic.⁴⁶

Key Takeaways

- According to Patricia Sias, people engage in workplace relationships for several reasons: mentoring, information, power, and support. Jessica Methot has further suggested that we engage in coworker relationships for trust, relational maintenance, and the ability to focus.
- Kathy Kram and Lynn Isabella have explained that there are three different types of workplace relationships: information peer, collegial peer, and special peer. Information peers are coworkers we rely on for information about job tasks and the organization itself. Collegial peers are coworkers with whom we have moderate levels of trust and self-disclosure and more openness that is shared between two individuals. Special peers, on the other hand, are coworkers marked by high levels of trust and self-disclosure, like a “best friend” in the workplace.
- Patricia Sias and Daniel Cahill created a list of influencing factors on coworker relationships. First, we are simply more drawn to some coworkers than others. As such, traditional notions of interpersonal attraction and homophily are at play. A second influencing factor involves contextual changes. Often there are specific contextual changes (e.g., moving offices, friendship opportunity, and friendship prevalence) that impact the degree to which people develop coworker friendships. Finally, communication changes as we progress through the four types of coworker friendships: acquaintance, friend, close friend, and almost best friend.
- Patricia Sias and Tarra Perry describe three different ways that coworkers can disengage from coworker relationships in the workplace. First, individuals can engage in state-of-the-relationship talk with a coworker, or explain to a coworker that a workplace friendship is ending. Second, individuals can make the cost of maintaining the relationship higher than getting out of the relationship, which is called cost escalation. The final disengagement strategy coworkers can utilize, depersonalization occurs when an individual stops all the interaction with a coworker that is not task-focused or simply to avoid the coworker.

Exercises

- Think about your workplace relationships with coworkers. Which of Patricia Sias’s four reasons and Jessica Methot’s three additional characteristics were at play in these coworker relationships?
- Kathy Kram and Lynn Isabella describe three different types of peers we have in the workplace: information peer, collegial peer, and special peer. Think about your workplace. Can you identify people who fall into all three categories? If not, why do you think you don’t have all three types of peers? If you do, how are these relationships distinctly different from one another?
- Think about an experience where you needed to end a workplace relationship with a coworker. Which of Patricia Sias and Tarra Perry’s disengagement strategies did you use? Do you think there are other disengagement strategies available beyond

the ones described by Sias and Perry?

13.4 Romantic Relationships at Work

LEARNING

OUTCOMES

1. Define the term “romantic workplace relationship.”
2. Reconstruct Charles Pierce, Donn Byrne, and Herman Aguinis’ model of romantic workplace relationships.
3. Describe Renee Cowan and Sean Horan’s four reasons why romantic workplace relationships develop.

In 2014 poll conducted by CareerBuilder.com and The Harris Poll, researchers found that 38% of U.S. workers had dated a coworker at least once, and 20% of office romances involved someone who is already married.⁴⁷ According to the press release issued by the researchers, “Office romances most often start with coworkers running into each other outside of work (12 percent) or at a happy hour (11 percent). Some other situations that led to romance include late nights at work (10 percent), having lunch together (10 percent), and love at first sight (9 percent).” Furthermore, according to data collected by Stanford University’s “How Couples Meet and Stay Together” research project, around 12% of married couples meet at work.⁴⁸ Meeting through friends is the number one way that people meet their marriage partners, but those who met at work were more likely to get married than those who met through friends.

In essence, workplaces are still a place for romance, but this romance can often be a double-edged sword for organizations. In the modern organization, today’s office fling can easily turn into tomorrow’s sexual harassment lawsuit.

Understanding Romantic Workplace Relationships

According to Charles Pierce, Donn Byrne, and Herman Aguinis, a **romantic workplace relationship** occurs when “two employees have acknowledged their mutual attraction to one another and have physically acted upon their romantic feelings in the form of a dating or otherwise intimate association.”⁴⁹ From this perspective, the authors noted five distinct characteristics commonly associated with workplace romantic relationships:

1. Passionate desire to be with one’s romantic partner;
2. Shared, intimate self-disclosures;
3. Affection and mutual respect;
4. Emotional fulfillment; and
5. Sexual fulfillment/gratification.

A Model of Romantic Workplace Relationships

In their article examining romantic workplace relationships, Pierce, Byrne, and Aguinis propose a model for understanding workplace relationships. Figure 13.6 is a simplified version of that basic model. The



Figure 13.6 Romantic Workplace

basic model is pretty easy to follow. First, it starts with the issue of propinquity, or the physical closeness of two people in a given space. One of the main reasons romantic relationships develop in the workplace is because we are around people in our offices every day. It's this physical proximity that ultimately leads people to develop interpersonal attractions for some people. However, just because we find someone interpersonally attractive doesn't mean we're going to jump into a romantic relationship with them. We will never develop romantic attractions for most (if not all) people that we find interpersonally attractive at work. However, romantic attraction does happen. At the same time, if you don't desire a workplace relationship, then even a romantic attraction won't lead you to start engaging in a workplace relationship. If, however, you decide or desire to workplace relationship, then you are likely to start participating in that romantic workplace relationship.

Once you start engaging in a romantic workplace relationship, there will be consequences of that relationship. Now, some of these consequences are positive, and others could be negative. For our purposes, we broadly put these consequences into three different categories: personal, professional, and organizational.

Personal Outcomes

The first type of outcomes someone may face are personal outcomes or outcomes that affect an individual and not their romantic partner. Ultimately, romantic relationships can have a combination of both positive and negative outcomes for the individuals involved. For our purposes here, we will assume that both romantic partners are single and not in any other kind of romantic relationship. As long as that romantic relationship is functioning positively, individuals will be happy, which can positively impact their job satisfaction, organizational commitment, and employee motivation. Employees engaged in romantic workplace relationships will even work longer hours so they can be with their romantic partners.

On the flip side, romantic relationships always have their ups and downs. If a relationship is not going well, the individuals in those romantic workplace relationships may experience adverse outcomes. In this case, we might see a decrease in job satisfaction, organizational commitment, and employee motivation. We might also see romantic partners trying to put more distance between themselves and their romantic partner at work. In these cases, people might avoid being placed on the same project or working longer hours to avoid spending extra time with their romantic partner.

Overall, it's important to remember that romantic workplace relationships can lead to personal

outcomes in the workplace environment. People often think they can keep their romantic and professional selves apart, but these distinctions can often become blurry and hard to separate.

Professional Outcomes

The second type of outcomes someone in a romantic workplace relationship may face are professional. According to Robert Quinn, there is a range of professional outcomes that can occur when someone is involved in a romantic relationship.⁵⁰ Quinn listed six basic outcomes someone people achieve professionally as a result of engaging in a romantic workplace relationship: advancement, job security, increased power, financial rewards, easier work, and job efficiency. Each of these professional outcomes is not guaranteed, and depends on the nature of the romantic relationship and who the partner is. If someone's partner has more power within the organization, they can show more favoritism towards their romantic partner. In contrast, individuals on the same rung of the hierarchy, may not have the ability to create professional advancement.

There is also the flipside to these professional outcomes. If a relationship starts to sour, someone could see their career advancement slowed, less job security, less power in the workplace, etc. It's in cases where romantic relationships sour (especially between individuals at different rungs of an organization's hierarchy) when we start to see the real problems associated with romantic workplace relationships.

Organizational Outcomes

The final type of outcomes happens not directly to the individuals within a romantic workplace relationship, but rather to the organization itself. Organizations face a wide range of possible outcomes that stem from romantic workplace relationships. When romantic workplace relationships are going well, organizations have members who are more satisfied, motivated, and committed. Of course, this all trickles over into higher levels of productivity.

On the other hand, there are also negative outcomes that stem from romantic workplace relationships. First, people who are in an intimate relationship with each other in the workplace are often the subjects of extensive office gossip.⁵¹ And this gossiping is time-consuming and can become a problem for a wide range of organizational members. Second, individuals who are "dating their boss" can provoke resentment by their peers if their peers perceive the boss as providing any kind of preferential treatment for their significant other in the workplace. Furthermore, not all romantic workplace relationships are going to turn out well. Many romantic workplace relationships will simply dissolve. Sometimes this dissolution of the relationship is amicable, or both parties are satisfied with the breakup and can maintain professionalism after the fact. Unfortunately, there are times when romantic workplace relationships dissolve, and things can get a bit messy and unprofessional in the workplace. Although happy romantic workplace relationships have many positive side-effects, negative romantic workplace relationships can have the negative outcomes for an organization leading to a decrease in job satisfaction, employee motivation, organizational commitment, and decreased productivity.

Many dissolutions of romantic workplace relationships could lead to formerly happy and productive organizational members looking for new jobs away from the person they were dating. In other cases (especially those involving people on different rungs of the organizational hierarchy), the organization could face legal claims of sexual harassment. Many organizations know that this last outcome is a real possibility, so they require any couple engaged in a romantic workplace relationship to enter into a consensual relationship agreement or "love contract" (see Side Bar for a sample love contract). Other organizations ban romantic workplace relationships completely, and people found violating the policy can

be terminated.

Why Romantic Workplace Relationships Develop

Robert Quinn was the first researcher to examine why individuals decide to engage in romantic workplace relationships.⁵² Renee Cowan and Sean Horan have more recently updated the list of motives Quinn created.⁵³ Cowan and Horan found that the modern worker engages in romantic workplace relationships for one of four reasons: ease of opportunity, similarity, time, and the hookup. The first three of these motives are very similar to other motives one generally sees in interpersonal relationships in general. Furthermore, these categories are not mutually exclusive categories. Let's examine these motives in more detail.

Ease of Opportunity

The first reason people engage in romantic workplace relationships; **ease of opportunity** happens because work fosters an environment where people are close to one another. We interact with a broad range of people in the workplace, so finding someone that one is romantically attracted to is not that surprising. This is similar to the idea of propinquity examined by Pierce, Byrne, and Aguinis in their romantic workplace relationship development model discussed earlier in this chapter.⁵⁴

Similarity

The second motive discussed by Cowan and Horan is **similarity**, or finding that others in the workplace may have identical personalities, interests, backgrounds, desires, needs, goals, etc. As discussed earlier in this book, we know that when people perceive others as having the same attitude, background, or demographic similarities (homophily), we perceive them as more like us and are more likely to enter into relationships with those people. The longer we get to know those people, the greater that probability that we may decide to turn this into a special peer relationship or a romantic workplace relationship.

Time

As we discussed at the very beginning of this chapter, we spend a lot of our life at work. In a typical year, we spend around 92.71 days at work (50-weeks a year \times 5 days a week \times 8.9 hours per day). You ultimately spend more **time** with your coworkers than you do with almost any other group of people outside your immediate family. When you spend this much time with people, we learn about them and develop a sense of who they are and what they're like. We also know that time is a strong factor when predicting sexual attraction.⁵⁵

The Hook Up

Speaking of sexual attraction, the final motive people have for engaging in romantic workplace relationships is called "the hook up" by Cowan and Horan. The purpose of "**the hook up**" is casual sex without any romantic entanglements. Unlike the other three motives, this one is less about creating a romantic workplace relationship, and more about achieving mutual sexual satisfaction with one's coworker. In Cowan and Horan's study, they do note, "What we found interesting about this theme was that it was only attributed to coworker's WRs [workplace relationships]. Although several participants described

A consensual romance agreement to be signed by two romantically-involved employees representing that their relationship is entirely consensual and acknowledging the employer's anti-harassment policies and rules. This Standard Document is drafted in favor of the employer. It is based on federal law. This Standard Document has integrated notes with important explanations and drafting tips. For information on state law requirements for discrimination and harassment, see Anti-Discrimination Laws: State Q&A Tool.

Consensual Romance in the Workplace Agreement (Love Contract)

DRAFTING NOTE: READ THIS BEFORE USING DOCUMENT

Employers allowing employees to engage in romantic relationships with one another can ask romantically involved employees to sign an agreement stating that their romantic relationship is entirely consensual and free from coercion, intimidation, and harassment. These agreements are often referred to as love contracts.

Employers should consider using this love contract to minimize legal risk associated with employee romantic relationships, particularly potential sexual harassment claims. For more information about the risks associated with employee romantic relationships, see Practice Notes, Romance in the Workplace (0-502-6127) and Harassment (9-502-7844).

USE OF A LOVE CONTRACT

Before employers request romantically involved employees to sign this agreement, they should interview each employee separately. They should record the conversation in written notes and ask questions designed to confirm that the relationship is entirely consensual. The employer should then explain each portion of the agreement to each employee separately and review the policies it references with them. Finally, the employer should ask each employee to review the agreement and to sign it if they agree with its terms.

MINIMIZING RISK

To further minimize risk, all employers should consider:

- n Implementing and uniformly enforcing an anti-harassment policy (for a sample policy, see Standard Document, Anti- Harassment Policy (7-501-6926)).
- n Implementing and uniformly enforcing a romance in the workplace policy (for a sample policy, see Standard Document, Romance in the Workplace Policy (8-502-7646)).
- n Conducting training on sexual harassment prevention (for more information, see Sexual Harassment Prevention Training Checklist (9-502-7349)).

BRACKETED TEXT

Counsel should replace bracketed text in ALL CAPS with information specific to the particular circumstances. Bracketed text in sentence case is optional or alternative language that counsel should include, modify, or delete, as appropriate. A forward slash in bracketed text indicates that counsel should choose from among two or more alternative words or phrases.

1. This number refers to other legal templates available from legalsolutions.com/practical-law.

1. Equal Employment Opportunity Workplace. The undersigned recognize and agree that it is [EMPLOYER NAME]'s policy to provide an equal opportunity in hiring, employment, promotion, compensation, and all other employment-related decisions without regard to race, color, religion, creed, national origin or ancestry, sex, age (40 or older), being a qualified person with a physical or mental disability, veteran status, genetic information, or any other basis set forth in the applicable federal, state, and local laws or regulations relating to discrimination in employment. The undersigned understand that [EMPLOYER NAME] does not tolerate unwelcome or offensive conduct or conduct that creates a hostile work environment that is in any way based on or related to a person having any of the characteristics described above.

The undersigned agree that they have received, read, and understand [EMPLOYER NAME]'s [NAME OF EQUAL EMPLOYMENT OPPORTUNITY POLICY] and agree to adhere to all of its terms.

DRAFTING NOTE: EQUAL EMPLOYMENT OPPORTUNITY WORKPLACE

Employers should consistently take advantage of opportunities to remind employees that they are an equal employment opportunity employer and that they do not discriminate based on any protected characteristic, whether under federal, state, or local law.

Employers should ensure employees acknowledge this fact in this type of agreement in case one or both later brings a claim for harassment or discrimination related to a failed relationship. For more information about the legal risks of a failed employee romantic relationship, see Practice Note, Romance in the Workplace (0-502-6127). For a sample equal employment opportunity policy, see Standard Document, Equal Employment Opportunity Policy (6-500-4349).

2. All Forms of Sexual Harassment Prohibited. The undersigned also recognize and agree that [EMPLOYER NAME] does not tolerate sexual harassment, a form of unlawful discrimination. Unwelcome sexual advances, requests for sexual favors, and other verbal or physical conduct of a sexual nature constitute sexual harassment when:

- submission to such conduct is made, explicitly or implicitly, a condition of an individual's employment or advancement;
- submission to or rejection of such conduct by an individual is used as the basis for employment decisions affecting the individual; or
- such unreasonable conduct interferes with an individual's work performance or creates an intimidating, hostile, or offensive working environment.

The undersigned agree that they have received, read, and understand [EMPLOYER NAME]'s [NAME OF ANTI-HARASSMENT POLICY] and agree to adhere to all of its terms.

DRAFTING NOTE: ALL FORMS OF SEXUAL HARASSMENT PROHIBITED

Sexual harassment is the most likely discriminatory practice an employee may claim if an employee romance goes awry. Accordingly, it is especially important to remind and request employees to acknowledge in writing that sexual harassment of any kind is absolutely prohibited and not tolerated (for more information on the different types of sexual harassment, quid pro quo and hostile work environment harassment, see Practice Note, Harassment (9-502-7844)).

It is also helpful to remind employees about the employer's anti-harassment policy, which should contain mandatory procedures for reporting harassment if it occurs, and request that they acknowledge the policy in writing. Having this policy and applying it uniformly assists employers in making a defense in certain sexual harassment cases called the Faragher-Ellerth defense. For more information about the importance of anti-harassment policies and the Faragher-Ellerth defense, see Practice Note, Harassment: Liability for HWE Harassment Subject to Faragher-Ellerth Defense (9-502-7844). For a sample anti-harassment policy, see Standard Document, Anti-Harassment Policy (7-501-6926).

3. Consensual Relationship. We, the undersigned employees, have entered into a personal relationship with each other. We agree as follows:

- Our relationship is entirely voluntary and consensual.
- Our relationship will not have a negative impact on our work.
- We will not engage in any public displays of affection or other behavior that might create a hostile work environment for others or that might make others uncomfortable.
- [We understand that one or both of us may need to transfer to another [department/group/ location] to remove any conflicts of interest in our working environment. If a transfer will not remove the conflict of interest, we understand that one of us may have to resign or be demoted to remove the conflict of interest. We further understand that [EMPLOYER NAME] will first ask us to choose which of us will be subject to a transfer, demotion, or resignation. If we fail to choose, [EMPLOYER NAME] will be forced to choose for us. We understand that [EMPLOYER NAME] will make such a decision without regard to any protected class characteristic and in compliance with [EMPLOYER NAME]'s [NAME OF EQUAL EMPLOYMENT OPPORTUNITY POLICY] and [NAME OF ROMANCE IN THE WORKPLACE POLICY].]
- We will act professionally toward each other at all times, even after the relationship has ended.
- We will not participate in any company decision making processes that could affect each other's pay, promotional opportunities, performance reviews, hours, shifts, or career, while in this relationship [and after the relationship ends].
- We agree that, if the relationship ends, we will inform [EMPLOYER NAME] if we believe it is necessary to protect our rights or if the [NAME OF ANTI-HARASSMENT POLICY] is violated.
- We each agree that, if the relationship ends, we will respect the other person's decision to end the relationship and will not retaliate against the other person, engage in any unprofessional or

inappropriate efforts to resume the relationship, or engage in any other conduct toward the other person that could violate the [NAME OF ANTI-HARASSMENT POLICY].

DRAFTING NOTE: CONSENSUAL RELATIONSHIP

This section, the most important of the agreement, allows employees to show that the parties represented to the employer that their relationship was free from harassment, coercion, or intimidation. This representation minimizes risk to the employer that one of the employees will later claim they were sexually harassed or pressured into the relationship. It also demonstrates to courts that the employees were on notice about their expected conduct should problems later arise.

ACKNOWLEDGING POTENTIAL CONFLICTS OF INTEREST

The employees also acknowledge in this section that their relationship could create a conflict of interest and agree to cooperate with certain procedures necessary to remove the conflict of interest, including an optional clause subjecting one or both of them to transfer, or in a worst-case scenario, demotion or termination.

Possible Conflicts in Reporting Structure

It is strongly recommended that employers do not permit romantically involved employees to remain in the same reporting structure. This may include circumstances where one employee supervises the other or any other structure where one of the employees is able to affect the terms and conditions of the other's employment. A lateral transfer of one of the employees to another department, group, or location is the easiest way to remove the conflict, but where a transfer is not possible or feasible, it may be necessary to consider a demotion or termination of one of the romantic partners. In all cases, the employer should ask the romantically involved employees to determine which employee will be affected to minimize risk of discrimination claims.

Decision Making Authority Over Terms and Conditions of Employment

In this section, the romantically involved employees also agree that they will not participate in any decision making processes that could affect each other's terms and conditions of employment. This clause contains an optional phrase allowing the employer to choose whether it should apply only for the duration of the relationship or afterwards as well. Although it may be logistically easier for the employer to limit it to the duration of the relationship, employers should strongly consider leaving the prohibition in place after the relationship ends to minimize risk of discrimination and retaliation claims (for more information about retaliation, see Practice Note, Retaliation (5-501-1430) and Standard Document, Anti-Retaliation Policy (8-503-5830)).

EMPLOYEE REPRESENTATIONS

The representations by the romantic partners also help ensure that the employees will not:

- Disrupt the workplace by acting unprofessionally.
- Allow the relationship to negatively impact their work.
- Negatively impact the environment of those around them.

Finally, the representations reiterate that the employees:

- Are aware of the employer's anti-harassment policy.
- Will not violate the policy in any way.
- Will follow its procedures for reporting any harassing behavior.

This minimizes risk of a harassment claim and increases the likelihood of being able to use the Faragher-Ellerth defense in litigation if necessary.

IN WITNESS WHEREOF, the undersigned have executed this Agreement as of the [DAY OF MONTH] day of [MONTH], [YEAR].

Dated this _____ day of _____, _____.

Employees:

(Employee Signature)

(Printed Name)

(Employee Signature)

(Printed Name)

Witness:

(Witness Signature)

(Printed Name)

Created by: Joseph L. Beachboard, Ogletree Deakins, with Practical Law Labor & Employment

Reprinted here with permission of Thomson Reuters

WRs they had engaged in, this motive was never attributed to those pursuits.”⁵⁶

How Coworkers View Romantic Workplace Relationships

The final part of this section is going to examine the research related to how coworkers view these romantic workplace relationships. The overwhelming majority of us will never engage in a romantic workplace relationship, but most (if not all) of us will watch others who do. Sometimes these relationships work out, but they don't. Some researchers have examined how coworkers view their peers who are engaging in romantic workplace relationships.

- Coworkers trust peers less when they were involved in a romantic workplace relationship with a supervisor than with a different organizational member.⁵⁷
- Coworkers reported less honest and accurate self-disclosures to peers when they were involved in a romantic workplace relationship with a supervisor than with a different organizational member.⁵⁸
- “Coworkers perceived a peer dating a superior to be more driven by job motives and less by love motives than they perceived peer dating individuals of any other status type.”⁵⁹
- Coworkers reported that they felt their peers were more likely to get an unfair advantage when dating their leader rather a coworker at a different level of the hierarchy.⁶⁰
- Peers dating subordinates were also felt to get an unfair advantage compared with peers dating people outside the organization.⁶¹
- Gay or lesbian peers who dated a leader were trusted less, deceived more, and perceived as less credible than a peer dating a peer.⁶²
- “Organizational peers are less likely to deceive gay and lesbian peers involved in WRs and to perceive gay and lesbian peers in WRs as more caring and of higher character than heterosexual peers who date at work.”⁶³
- Women who saw higher levels of sexual behavior in the workplace have lower levels of job satisfaction, but there was no relationship between observing sexual behaviors at work and job satisfaction for men.⁶⁴
- When taking someone's level of job satisfaction out of the picture, people who saw higher levels of sexual behavior in the workplace were more likely to look for another job.⁶⁵

As you can see, dating in the workplace and open displays of sexuality in the workplace have some interesting outcomes for both the individuals involved in the relationship, their peers, and the organization.

Key Takeaways

- According to Charles Pierce, Donn Byrne, and Herman Aguinis, a romantic workplace relationship occurs when “two employees have acknowledged their mutual attraction to one another and have physically acted upon their romantic feelings in the form of a dating or otherwise intimate association.”
- Charles Pierce, Donn Byrne, and Herman Aguinis' model of romantic workplace relationships (Seen in Figure 13.6) have six basic stages: propinquity, interpersonal attraction, romantic attraction, desire for romantic relationship, engagement

in workplace relationship, and outcomes of workplace relationship (personal, professional, and organizational).

- Renee Cowan and Sean Horan found four basic reasons why romantic workplace relationships occur: ease of opportunity, similarity, time, and the hookup. First, relationships develop because we are around people a lot, and we are naturally drawn to some people around us. Second, we perceive ourselves as similar to coworkers having identical personalities, interests, backgrounds, desires, needs, goals, etc. Third, we spend a lot of time at work and the more we spend time with people the closer relationships become and can turn into romantic ones. Lastly, some people engage in romantic workplace relationships for casual sex without any kind of romantic entanglements, known as the hookup.
- As a whole, the research on coworkers and their perceptions of romantic workplace relationships are generally more in favor of individuals (both gay/lesbian and straight) who engage in relationships with coworkers at the same level. Coworkers do not perceive their peers positively when they are dating someone at a more senior level (especially one's direct supervisor). Furthermore, observing coworkers engaging in sexual behaviors tends to lead to decreases in job satisfaction, which can lead to an increase in one's desire to find another job.

Exercises

- Where do you think the difference lies between romantic workplace relationships and sexual harassment?
- When you evaluate the reasons people engage in romantic workplace relationships described by Renee Cowan and Sean Horan, do you think their list is complete? Do you believe there are other reasons people engage in romantic workplace relationships?
- If you decided to engage in a romantic workplace relationship, would you be comfortable signing a "love contract" with your human resources department? Does your opinion differ if the target of your romantic affection is a follower, peer, or leader?

13.5 Problematic Workplace Relationships

LEARNING OUTCOMES

1. Define and explain the term deviant workplace behavior.
2. Explain Janie Harden Fritz's six types of problematic bosses.
3. Describe Janie Harden Fritz's eight types of problematic coworkers.
4. Assess Janie Harden Fritz's five types of problematic subordinates.

Eventually, everyone is going to run into someone within the workplace that is going to drive them crazy.

There are many books out there designed to help you deal with difficult people, toxic people, workplace vampires, jerks, energy drainers, etc. Some of these people are just irritants, whereas other problem people can be more egregious (e.g., aggressive, bullying, deviating from work norms, overly cynical about everything).

We view these people as problem people because they ultimately take more of our resources to deal with. There's a reason some writers refer to "problem people" as **emotional vampires** because we have to use more of our emotional resources to deal with these people, and they increase our levels of stress along the way.⁶⁶ In this section,

we are going to explore the different types of problem people we come in contact within the workplace and how we can strive towards workplace civility. In organizational literature, we often refer to these people as engaging in **deviant workplace behavior**, or voluntary behavior of organizational members that violates significant organizational norms and practices or threatens the wellbeing of the organization and its members.

Research on problem people in the workplace tends to demonstrate that we have problem people at all levels of the organization. We have problematic bosses, peers, and subordinates. In 2002 (later updated in 2009), Janie Harden Fritz created a typology of the different types of problem people we encounter in the workplace.^{67,68} Figure 13.7 shows the typology. In this typology, Harden Fritz discusses how different positions in the workplace can lead to varying types of problem people. Let's examine each of these individually.

Problem Bosses

Through Harden Fritz's research into bosses, she found that there are six common types of problematic



Figure 13.7 Problematic People in the Workplace

bosses: the different, the good old boy or good old girl, the okay, the toxic, the self-centered taskmaster, and the intrusive harasser.

The Different Boss

First, The Different Boss is someone a subordinate sees as distractingly different from them as a person. Different subordinates are going to view what is “distractingly different” in a wide range of different ways. Some people who view their bosses as “distractingly different” may also be succumbing to their prejudices about people from various social groups. For example, if someone’s boss is from another country, those cultural differences can make that subordinate see their boss as distractingly different.

The Good Old Boy or Good Old Girl Boss

Second is the good old boy or good old girl boss. This type of boss is someone who probably hasn’t progressed along with the modern world of corporate thinking. This person may be gregarious and outgoing, but they tend to see the “old ways of doing things” as best—even when they’re problematic. These individuals tend to see sexual harassment as something that isn’t a big deal in the workplace. Their subordinates are also more likely to view some of their behaviors as unethical.

The Okay Boss

The third type of boss is the okay boss. This person is exactly like the name says, okay and average in just about every way possible. These individuals are, in many ways, coasting towards retirement. They try not to rock the boat within the organization, so they will never stand up to their bosses, nor will they advocate for their subordinates. For someone who likes work and wants to succeed in life, working for one of these people can be very frustrating because the okay boss likes the status quo and creates an environment in which the average is the norm and people who exceed the average are the outcasts.

The Toxic Boss

Fourth, we have the toxic boss. These bosses are all-around problematic in the workplace. They are often seen as unethical, obnoxious, and unprofessional by their subordinates. These are the types of bosses that can create hostile work environments and pit employees against each other for their amusement. However, when it comes to harassing behavior, they are less likely to engage in harassment directly. Still, they can often create environments where both sexual harassment and bullying become the norm.

The Self-Centered Taskmaster

The fifth type of problematic boss is the self-centered taskmaster. The self-centered taskmaster is ultimately “focused on getting the job done to advance their own goals, without concern for others.”

⁶⁹ This type of boss is purely focused on getting work done. This individual may be excessive in the amount of work they give subordinates. Ultimately, this individual wants to show their superiors how good of a boss they are to move up the organizational hierarchy. On the flip side, these people are highly competent, but their tendency to lord power over others in an obnoxious way makes working for this type of boss very stressful.

The Intrusive Harasser Boss

Sixth, we have the intrusive harasser boss. This individual tends to be highly interfering and often wants to get caught up in their subordinates' personal and professional lives. They are likely to be overly attentive in the workplace, which can interfere with an individual's ability to complete their task assignments. Furthermore, this boss is likely to be one who engages in activities like sexual harassment, backstabbing, and busybody behavior.

Problem Coworkers

Through her research into coworkers, Harden Fritz has found that there are eight common types of problematic coworkers: the adolescent, the bully, the mild annoyance, the independent self-promoter, the pushy playboy or playgirl, the independent other, the soap opera star, and the the abrasive, incompetent harasser.

The Adolescent

The first common problematic coworker is the adolescent. The adolescent is the Peter Pan of the business world, they don't want to grow up. These people tend to want to be the center of attention and will be the first to let everyone know when they've accomplished something. You almost feel like you need to give them a Scooby Snack just for doing their job. However, if someone dares to question them, they tend to become very defensive, probably because they don't want others to know how insecure they feel.

The Bully

Second, we have the bully. This individual has a knack of being overly demanding on their peers, but then dares to take credit for their peers' work when the time comes. This is your prototypical schoolyard bully all grown up and in an office job. In their 2005 study, Charlotte Rayner and Loreleigh Keashly examined the available definitions for "workplace bullying" and determined five specific characteristics:

1. The experience of negative behavior;
2. Behaviors experienced persistently;
3. Targets experiencing damage;
4. Targets labeling themselves as bullied; and
5. Targets with less power and difficulty defending themselves.⁷⁰

You'll notice from this list that being a bully isn't a one-off behavior for these coworkers. This behavior targets individuals in a highly negative manner, happens over a long period, and can have long-term psychological and physiological ramifications for individuals who are targeted. We should note that bullies do not happen in isolation, but more often than not run in packs. For this reason, a lot of European research on this subject has been referred to as mobbing instead of bullying. Sadly, this is an all-too-frequent occurrence in the modern work world. In a large study examining 148 international corporations through both qualitative and quantitative methods, Randy Hodson, Vincent Roscigno, and Steven Lopez report that 49% of the organizations they investigated had routine patterns of workplace bullying.⁷¹

The Mild Annoyance

The third type of problematic coworker is the mild annoyance. When it comes down to it, this person isn't going to ruin your day, but they are mildly annoying on a routine basis. Maybe it's a coworker who wants to come in every morning and talk to you about what they watched on television the night before while you're trying to catch up on email. Or maybe it's the coworker who plays music a little too loudly in the workplace. There are all kinds of things that can annoy us as human beings, so the mildly annoying coworker is one that generally is tolerated.

The Independent Self-Promoter

Fourth, we have the independent self-promoter. The independent self-promoter is someone who likes to toot their own horn at work. This individual tends to be slightly to extremely narcissistic, thinking the world revolves around them. These individuals are not the type to take credit for other people's work, but they also aren't the type to do work that needs to be done unless they see its utility in making them look good.

The Pushy Playboy or Playgirl

The fifth problematic coworker is the pushy playboy or playgirl. The pushy playboy or playgirl is an individual marked by their tendency to push other coworkers into doing things for the pushy playboy or playgirl. Often these tasks have nothing to do with work at all. For example, the pushy playboy or playgirl would be the type of person to demand that a younger or more submissive coworker run down the street for a Starbucks run. Furthermore, these are the types of people who tend to be overly demanding of coworkers and then misrepresent their performance to those higher up in the corporate food chain.

The Independent Other

The sixth common problematic coworker is the independent other. In many ways, the independent other is similar to the different bosses discussed earlier. These people tend to be perceived as uniquely different from their coworkers. There are a lot of characteristics that can make someone viewed as uniquely other. Any specific demographic that goes against the workplace norm could be cause for perceiving someone as different: age, sex, gender, sexual orientation, religion, ethnicity, race, etc. Some people may view them as having a low work ethic, but this perception may stem out of that perceived "otherness."

The Soap Opera Star

The seventh common problematic coworker identified by Harden Fritz is the soap opera star.⁷² The soap opera star lives for drama in the workplace. New rumors of office romances? This person will have the 411 and probably a Tumblr page devoted to the couple. For this reason, this person tends to be a busybody to the nth degree and will be all up in everyone's business both at work and in their personal lives. Because of their tendency towards drama (both finding it and often creating it), they are generally seen as highly distracting by their peers. At the same time, they tend to spend so much time digging for office gossip that they are typically perceived as having a poor work ethic by others.

The Abrasive, Incompetent Harasser

The final type of problematic coworker is the abrasive, incompetent harasser, which is an individual who

tends to be highly uncivil in the workplace with a particular emphasis on sexually harassing behavior. This coworker is very similar to the intrusive harasser boss discussed earlier. This individual is generally viewed as incompetent and unprofessional in the workplace. This person tends to score high on all of the problematic work behaviors commonly seen by coworkers.

MINDFULNESS ACTIVITY



There are a ton of books on the market designed for business people to help them get along with their coworkers. Like it or not, but we all are going to work with people that drive us crazy. So, what's a mindful way to approach these situations when you have to interact with a coworker is far from being mindful. As usual, our first steps should always be attention, intention, and attitude. However, we can only control our perspectives about others and not their behaviors.

Think of a time when you had to interact with a coworker who was not behaving mindfully.

1. How was their behavior problematic? How did you feel challenged by this person?
2. What was the outcome of this person's behavior on your mindfulness practice, your relationship, or your work?
3. If others were involved, how did they respond?
4. What role (if any) did you play in triggering this person's behavior?
5. What will take away from this experience? How can you approach this person more mindfully in the future?

Research Spotlight



In their 2017, Stacy Tye-Williams and Kathleen J. Krone examine the advice given to victims of workplace bullying. Going into this study, the researchers realized that a lot of the advice given to victims makes it their personal responsibility to end the bullying, "You should just stand up to the bully" or "You're being too emotional this."

The researchers interviewed 48 people who had been the victims of workplace bullying (the average age was 28). The participants had worked on average for 5 ½ years in the organization where they were bullied. Here are the top ten most common pieces of advice victims received:

1. Quit/get out
2. Ignore it/blow it off/do not let it affect you
3. Fight/stand up
4. Stay calm
5. Report the bullying
6. Be quiet/keep mouth shut
7. Be rational
8. Journal

9. Avoid the bully

10. Toughen up

The researchers discovered three underlying themes of advice. First, participants reported that they felt they were being told to downplay their emotional experiences as victims. The second was what the researchers called the “dilemma of advice,” or the tendency to believe that the advice given wasn’t realistic and wouldn’t change anything. Furthermore, many who followed the advice reported that it made things worse, not better. Lastly, the researchers note the “paradox of advice.” Some participants wouldn’t offer advice because bullying is contextual and needs a more contextually-based approach. Yet others admitted that they offered the same advice to others that they’d been offered, even when they knew the advice didn’t help them at all.

The researchers ultimately conclude, “The results of this study point to a paradoxical relationship between advice and its usefulness. Targets felt that all types of advice are potentially useful. However, the advice either would not have worked in their case or could possibly be detrimental if put into practice.”⁷³ Ultimately, the researchers argue that responding to bullying must first take into account the emotions the victim is receiving, and that responses to bullying should be a group and not a single individual’s efforts.

Tye-Williams, S., & Krone, K. J. (2017). Identifying and re-imagining the paradox of workplace bullying advice. *Journal of Applied Communication Research*, 45(2), 218–235. <https://doi.org/10.1080/00909882.2017.1288291>

Problem Subordinates

In the two previous sections, we’ve looked at problematic bosses and coworkers, but subordinates can also be a bit of a problem in the workplace. For this reason, Harden Fritz identifies five clear troublesome subordinates: the okay subordinate, the abrasive harasser, the bully, the different other, and the incompetent renegade.⁷⁴

The Okay Subordinate

First, we have the okay subordinate. Just like the name suggests, this person is neither stellar nor awful; this person is just okay. This person does tend towards being a mildly annoying busybody at work. Still, none of their behavior rises to the status where a supervisor would need to step in and counsel the employee’s behavior formally.

The Abrasive Harasser

Second, we have the abrasive harasser. The abrasive harasser is an individual who need regular counseling about what constitutes sexual harassment. They may not even always realize what types of behavior are appropriate in the workplace. For example, this subordinate could forward their supervisor a sexual joke via email without thinking others could perceive the joke as inappropriate. On the more extreme end, you have people who are perpetual sexual harassers who need to be severely counseled to protect the organization. In some cases, the person will need to be fired for harassing behavior.

The Bully

The next common problem subordinate is the bully. According to Harden Fritz, this subordinate is one “who bosses others, usurps authority, is competitive and is at the same time insecure.”⁷⁵ If this person’s behavior is not curtailed by their supervisor, it can quickly become infectious and end up hurting cohesion throughout the entire office. Furthermore, supervisors need to recognize this behavior and

ensure that the targets of the bully have a safe and secure place to work. Don't be surprised if this person decides to bully upward, or attempt to bully their supervisor.

The Different Other

The fourth common problem subordinate is the different other. Just like the two previous versions of "difference" discussed for bosses and coworkers, the different other is a subordinate who is perceived as distinctly different from their supervisor. One thing we know from years of management research is that people who are perceived as different from their supervisors are less likely to enjoy protective and mentoring relationships with their supervisors. As such, when a supervisor views someone as a "different other," they may engage in subconscious discriminatory behavior towards their subordinate.

The Incompetent Renegade

Finally, we have the incompetent renegade. This individual tends to be ethically incompetent and views themselves as above the law within the organization. This individual may view themselves as better than the organization to begin with, which causes a lot of problems around the office. However, instead of accomplishing their work, this person is more likely to take credit for others' work. If this subordinate is allowed to keep behaving in this manner, they will be viewed by others as running the place. For this reason, subordinates need to immediately initiate counseling to stop the behavior and build a case for termination if the behavior does not cease.

Key Takeaways

- Workplace deviance involves the voluntary behavior of organizational members that violates significant organizational norms and practices or threatens the wellbeing of the organization and its members.
- Janie Harden Fritz has categorized six types of problematic bosses: different, okay good old boy/girl, toxic, self-centered taskmaster, and intrusive harasser. First, the different boss is someone a subordinate sees as distractingly different from them as a person. Second, the good old boy/girl boss considers the "old ways of doing things" as best—even when they're problematic. Third, the okay boss is okay and average in just about every way possible, coasting towards retirement. Fourth, the toxic boss is seen as unethical, obnoxious, and unprofessional by their subordinates. Fifth, the self-centered taskmaster is entirely concerned with completing tasks with no concern for developing relationships with their followers. Lastly, the intrusive harasser boss tends to be highly interfering and often wants to get caught up in their subordinates' personal and professional lives.
- Janie Harden Fritz categorized eight types of problematic coworkers: adolescent (wants to be the center of attention and get nothing done), the bully (is overly demanding of their peers and takes credit for their work), the mild annoyance (engages in disruptive behaviors regularly but not to a drastic degree), the independent self-promoter (likes to toot their own horn), the pushy the playboy or playgirl (pushes people into doing things for them), independent other (perceived as distinctly different from their coworkers), the soap opera star (loves to gossip and be in the middle of all of the workplace drama), and the abrasive, incompetent

harasser (is highly uncivil in the workplace with a special emphasis in sexually harassing behavior).

- Janie Harden Fritz categorized five types of problematic subordinates: the okay subordinate, the abrasive harasser, the bully, the different other, and the incompetent renegade. First, the okay substitute is a follower who is not stellar or awful, just very much middle of the road. Second, the abrasive harasser is an individual who tends to be someone who needs counseling regularly about what constitutes sexual harassment. Third, the bully is someone who bosses their peers around, usurps authority, and engages in hypercompetitive behavior when competition is not necessary (all signs of someone who is deeply insecure). Fourth, the different other is a follower who is perceived as distinctly different from their supervisor. Finally, the incompetent renegade is ethically incompetent and views themselves as above the law within the organization.

Exercises

- Which of the six types of problematic bosses would you have the most problem working for? Why?
- In both the coworker and subordinate categories, “difference” is viewed as a problem in the workplace. Why do you think so many workers have a problem with difference? How should management approach situations where difference is impacting coworker relationships or leader-follower relationships?
- Think of a time when you’ve worked with a problematic coworker. Which of Janie Harden Fritz’s eight types of problematic coworkers did your coworker fit into? Did they fit into more than one? How did you handle this coworker relationship?

Chapter Wrap-Up

At the beginning of this chapter, we discussed how a good chunk of our lives is spent at work, so engaging in a range of interpersonal relationships in the workplace is unavoidable. We started the chapter by defining the term “professionalism” and what it means to be a professional in today’s workplace. We then scratched the surface of the communication and leadership research that examines leadership and followership. We discussed one of the most common relationships we have in the workplace, the coworker relationship. Coworker relationships were followed by an examination of romantic entanglements in the workplace, along with their pros and cons. We end this chapter looking at problematic interpersonal relationships in the workplace.

KEY TERMS

- Career Strategizing
- Collegial peers
- Cost Escalation
- Depersonalization
- Deviant Workplace Behavior
- Directive Support
- Ease of Opportunity
- Emotional Vampires
- Ethics
- Excuse-Making
- Followership
- Formal Language
- Informal Language
- Information Peers
- Jargon
- Leader-member Exchange
- Personal responsibility
- Profession
- Professionalism
- Relational Maintenance
- Romantic Workplace Relationship
- Similarity
- Social Support
- Special Peer
- State-of-the-Relationship Talk
- Supportive Leadership Behavior
- The Hookup
- Time
- Workplace Socialization

REAL WORLD CASE STUDY

Morren Michaels had been working with Raja Rahal for several years, and the two were pretty friendly with each other. They went out to eat after work and often strategized on how to make their office better. The two weren't exactly best friends in the workplace, but they were friends.

Out of nowhere, Morren was promoted by the CEO of the company and asked to take over the reins of her division. At first, things were smooth sailing. Morren had no problems, and the division was more profitable under her leadership than it had been under the previous manager. However, Morren quickly realized she was going to have problems with her old friend Raja. Almost immediately, Raja pointed out that Morren was "not one of us" anymore to the rest of the division since Morren was now in management. At first, it was a snide remark, but things quickly started escalating.

Anytime Raja didn't get her way, she would email everyone up the corporate ladder with her complaints against Morren (e.g., the head of HR, the CEO, the chief operating officer). In Morren's mind, all she was doing was expecting the same level of work from Raja as she did from anyone else in her division. One day in a meeting, Morren asked Raja to take on a new project. Surprisingly, Raja said yes and thought it was a good fit for her. Morren asked Raja to give the group an update on the project at the next meeting.

Throughout the next month, Morren checked in with Raja to see how the project was going. Raja scheduled a couple of meetings with Morren to talk about the project, but had to cancel because she was sick or her kid was sick. Morren even suggested meeting at a coffee shop near Raja's house to make things easier, but Raja had to bail out because she'd forgotten she'd scheduled another appointment.

Ultimately, the day of the next meeting came. When Morren got to the place on the agenda where Raja was supposed to report in, Raja looked at the entire group and said, "I never agreed to do that." Morren sat stunned as the rest of the division sat there uncomfortably. Finally, Morren pulled herself together and informed Raja that she had indeed agreed to take on the project. And that the

meeting minutes from the previous meeting along with the tape recording of the last meeting kept by the secretary, showed her agreeing.

After the meeting, Morren went back into her office and closed the door. She was a bit dumbfounded by what transpired. After the meeting, many of her coworkers came up to her to see if she was okay. They all said variations of the same thing, “We heard her agree to take on the project last month.” Thankfully, Morren had the secretary record their meetings to make taking notes easier. She then put the audio recordings on an internal server so all members of the department could relisten to them if necessary.

Morren sat her desk, opened her email, and quickly noticed an email from Raja. Morren could only imagine what the email would say. As she read the email, she was concerned at how twisted the facts of what had transpired had become. Raja accused Morren of embarrassing her during the meeting by falsely accusing her of not having done her job. Of course, the email was copied to everyone within the division and the higher corporate hierarchy.

1. Why do you think Morren and Raja’s relationship changed when Morren took on a position of leadership?
1. What type of problematic follower do you think Raja is?
2. If you were Morren, what would your next step be? Why?

END OF CHAPTER QUIZ

1. In an attempt to make herself look good in the organization, Agatha tends to hoard information. If something important comes across her desk, she tends to keep it instead of giving it to the people who could use the information. What type of unethical organizational communication is Agatha engaging in, according to W. Charles Redding?
 - a. Coercive
 - b. Sestructive
 - c. Seceptive
 - d. Intrusive
 - e. Acretive
2. Which of the following is NOT a way to take personal responsibility in the workplace?
 - a. Acknowledging that you are responsible for your choices in the workplace.
 - b. Acknowledging that you are responsible for how you feel at work.
 - c. Accepting that you can control your stress and feelings of burnout.
 - d. Deciding to take control of your attitudes, thoughts, and behaviors.
 - e. Deciding to let your supervisor determine the best path for your self-improvement.
3. During a meeting, Barba says, “I will not be joining the rest of the group this weekend at the trade show due to a pre-arranged meeting I have had on my schedule for a few months.” The use of the words “will not” and “I have” instead of their contraction forms are examples of what type of language use?
 - a. Common
 - b. Formal
 - c. Informal
 - d. Jargon
 - e. Peripheral

4. At work, Stella has an inherent need to be seen as her supervisor's peer and not as an underling. Stella does support her supervisor, but she has no problem confronting her supervisor when Stella thinks her supervisor is making a bad decision. According to Ira Chaleff, what type of follower is Stella?
 - a. Avoider
 - b. Implementer
 - c. Individualist
 - d. Partner
 - e. Resource

5. Susan always looks at her coworker Polly as a kind of problem. Polly came from a very religious upbringing and didn't seem to fit in with the rest of the people who work at GenCorp. For example, when Susan and her coworkers go out to eat, Polly doesn't join them because her male colleagues will be there. Polly also doesn't have any sense of pop culture at all. At a meeting recently, someone mentioned Lady Gaga, and Polly asked if she was a member of British royalty. Although everyone had a good laugh and Polly played along, Susan could tell that Polly was completely unaware of why her question was funny. According to Janie Harden Fritz, Polly is an example of what kind of "problematic coworker" for Susan?
 - a. The adolescent
 - b. The mild annoyance
 - c. The independent other
 - d. The soap opera star
 - e. The pushy playgirl

References

- 1 U.S. Department of Labor, Office of Disability Employment Policy. (2012). *Soft skills to pay the bills: Mastering soft skills for workplace success*. Retrieved from <http://www.dol.gov/odep/topics/youth/softskills/>; pg. 114.
- 2 Ibid.; pg. 114.
- 3 *The Oxford English Dictionary*. (1963). At the Clarendon Press.
- 4 Redding, W. C. (1996). Ethics and the study of organizational communication: When will we wake up? In J. A. Jaksas & M. S. Pritchard (Eds.), *Responsible communication: Ethical issues in business, industry, and the professions* (pp.17-40). Hampton Press.
- 5 Lee, B. (2016). A mindful path to a compassionate cultural diversity. In M. Chapman-Clarke (Ed.), *Mindfulness in the workplace: An evidence-based approach to improving wellbeing and maximizing performance* (pp. 266-287). Kogan Page.
- 6 Wing, D. (2010, November 17). Microaggressions in everyday life: More than just race – Can microaggressions be directed at women or gay people? *Psychology Today*. <https://tinyurl.com/ycm6ky7n>; para. 2.
- 7 Lee, B. (2016). A mindful path to a compassionate cultural diversity. In M. Chapman-Clarke (Ed.), *Mindfulness in the workplace: An evidence-based approach to improving wellbeing and maximizing performance* (pp. 266-287). Kogan Page; pg. 283.
- 8 Snyder, C. R., & Higgins, R. L. (1988). Excuses: Their effective role in the negotiation of reality. *Psychological Bulletin*, 104(1), 23-35. <https://doi.org/10.1037/0033-2909.104.1.23>
- 9 Hill, D. J., Baer, R., & Kosenko, R. (1992). Organizational characteristics and employee excuse making: Passing the buck for failed service encounters. *Advances in Consumer Research*, 19, 673-678. See Also Hill, D. J., & Baer, R. (1994). Customers complain--businesses make excuses: The effects of linkage and valence. *Advances in Consumer Research*, 21, 399-405.
- 10 Bellizzi, J. A., & Norvell, D. (1991). Personal characteristics and salesperson's justifications as moderators of supervisory discipline in cases involving unethical salesforce behavior. *Journal of the Academy of Marketing Science*, 19, 11-16.
- 11 Nordrum, A. (2014). What's Your Excuse? *Psychology Today*, 47(4), 22.
- 12 Payscale. (2016). *2016 Workforce-Skills Preparedness Report*. Retrieved from <https://www.payscale.com/data-packages/job-skills>
- 13 Primack, B. A., Roberts, T., Fine, M. J., Dillman Carpentier, F. R., Rice, K. R., & Barnato, A. E. (2012). ER vs. ED: A comparison of televised and real-life emergency medicine. *Journal of Emergency Medicine*, 43(6), 1160-1166. <https://doi.org/10.1016/j.jemermed.2011.11.002>
- 14 Hersey, P., & Blanchard, K. H. (1969). Life cycle theory of leadership. *Training and Development Journal*, 23(5), 26-34.
- 15 Ibid.
- 16 Dansereau, F., Graen, G., & Haga, W. J. (1975). A vertical dyad linkage approach to leadership within formal organizations: A longitudinal investigation of the role making process. *Organizational Behavior and Human Performance*, 13(1), 46-78. [https://doi.org/https://doi.org/10.1016/0030-5073\(75\)90005-7](https://doi.org/https://doi.org/10.1016/0030-5073(75)90005-7)
- 17 Graen, G. B., & Uhl-Bien, M. (1995). Relationship-based approach to leadership: Development of leader-member exchange (LMX) theory of leadership over 25 years: Applying a multi-level multi-domain perspective. *Leadership Quarterly*, 6(2), 219-247. [https://doi.org/10.1016/1048-9843\(95\)90036-5](https://doi.org/10.1016/1048-9843(95)90036-5)
- 18 Lussier, R. N., & Achua, C. F. (2007). *Leadership: Theory, application, skill development* (3rd ed.). Thomson/South-Western, p. 254.
- 19 Ibid.; p. 254.
- 20 Graen, G.B., & Uhl-Bien, M. (1991). The transformation of professionals into self-managing and partially self-designing contributions: Toward a theory of leader-making. *Journal of Management Systems*, 3(3), 33-48.

- 21 Ibid.; pg. 33.
- 22 Gagnon, M. A., & Michael, J. H. (2004). Outcomes of perceived supervisor support for wood production employees. *Forest Products Journal*, 54, 172–178.
- 23 Lussier, R. N., & Achua, C. F. (2007). *Leadership: Theory, application, skill development* (3rd ed.). Thomson/South-Western.
- 24 Gagnon, M. A., & Michael, J. H. (2004). Outcomes of perceived supervisor support for wood production employees. *Forest Products Journal*, 54, 172–178.
- 25 Wrench, J. S., Punyanunt Carter, N., & Ward, M., Sr. (2015). *Organizational communication: Theory, research, and practice*. Flat World Knowledge.
- 26 Omilion-Hodges, L. M., & Sugg, C. E. (2019). Millennials' views and expectations regarding the communicative and relational behaviors of leaders: Explore young adults' talk about work. *Business and Professional Communication Quarterly*, 82(1), 74-100. <https://doi.org/10.1177/2329490618808043>
- 27 Omilion-Hodges, L. M., Shank, S. E., & Packard, C. M. (2019). What young adults want: A multistudy examination of vocational anticipatory socialization through the lens of students' desired managerial communication behaviors. *Management Communication Quarterly*, 33(4), 512–547. <https://doi.org/10.1177/0893318919851177>; pg., 520.
- 28 Omilion-Hodges, L. M., Shank, S. E., & Packard, C. M. (2019). What young adults want: A multistudy examination of vocational anticipatory socialization through the lens of students' desired managerial communication behaviors. *Management Communication Quarterly*, 33(4), 512–547. <https://doi.org/10.1177/0893318919851177>; pg, 524.
- 29 Wrench, J. S., Punyanunt Carter, N., & Ward, M., Sr. (2015). *Organizational communication: Theory, research, and practice*. Flat World Knowledge; pg. 209.
- 30 Chaleff, I. (2003). *The courageous follower* (2nd ed.). Barrett-Koehler.
- 31 Sias, P. M. (2009). *Organizing relationships: Traditional and emerging perspectives on workplace relationships*. Sage.
- 32 Methot, J. R. (2010). *The effects of instrumental, friendship, and multiplex network ties on job performance: A model of coworker relationships* [Unpublished Doctoral Dissertation]. University of Florida. Retrieved from <http://ufdc.ufl.edu/UFE0041583/00001>
- 33 Ibid.; pg. 45
- 34 Dindia, K., & Canary, D. J. (1993). Definitions and theoretical perspectives on maintaining relationships. *Journal of Social and Personal Relationships*, 10(2), 163-173. <https://doi.org/10.1177/026540759301000201>
- 35 Methot, J. R. (2010). *The effects of instrumental, friendship, and multiplex network ties on job performance: A model of coworker relationships* [Unpublished Doctoral Dissertation]. University of Florida. Retrieved from <http://ufdc.ufl.edu/UFE0041583/00001>; pg. 49
- 36 Ibid; pg. 47
- 37 Kram, K. E., & Isabella, L. A. (1985). Mentoring alternatives: The role of peer relationships in career development. *Academy of Management Journal*, 28(1), 110–132. <https://doi.org/10.5465/256064>
- 38 Ibid.; pg. 121
- 39 Zellars, K. L., & Perrewé, P. L. (2001). Affective personality and the content of emotional social support: Coping in organizations. *Journal of Applied Psychology*, 86(3), 459–467. <https://doi.org/10.1037/0021-9010.86.3.459>
- 40 Sias, P. M., & Cahill, D. J. (1998). From coworkers to friends: The development of peer friendships in the workplace. *Western Journal of Communication*, 62(3), 273–299. <https://doi.org/10.1080/10570319809374611>
- 41 Ibid.
- 42 Nielsen, I. K., Jex, S. M., & Adams, G. A. (2000). Development and validation of scores on a two-dimensional workplace friendship scale. *Educational and Psychological Measurement*, 60(4), 628-643. <https://doi.org/10.1177/00131640021970655>
- 43 Nielsen, I. K., Jex, S. M., & Adams, G. A. (2000). Development and validation of scores on a two-dimensional workplace friendship scale. *Educational and Psychological Measurement*, 60(4), 628-643. <https://doi.org/10.1177/00131640021970655>

org/10.1177/00131640021970655

- 44 Sias, P. M., & Cahill, D. J. (1998). From coworkers to friends: The development of peer friendships in the workplace. *Western Journal of Communication*, 62(3), 273–299. <https://doi.org/10.1080/10570319809374611pg.288>.
- 45 Sias, P. M., & Perry, T. (2004). Disengaging from workplace relationships: A research note. *Human Communication Research*, 30(4), 589–602. <https://doi.org/10.1111/j.1468-2958.2004.tb00746.x>
- 46 Ibid.
- 47 CareerBuilders.com. (2014). Thirty-eight percent of workers have dated a co-worker, finds CareerBuilder Survey: Twenty percent of office romances involve someone who is already married [Press release]. Retrieved from http://www.careerbuilder.com/share/aboutus/pressreleasesdetail.aspx?sd=2/13/2014&siteid=cbpr&sc_cmp1=cb_pr803_&id=pr803&ed=12/31/2014
- 48 Rosenfeld, M. J., Thomas, R. J., & Falcon, M. (2011, 2014). *How couples meet and stay together, Waves 1, 2, and 3: Public version 3.04, plus wave 4 supplement version 1.02* [Computer files]. Stanford University Libraries.
- 49 Pierce, C. A., Byrne, D., & Aguinis, H. (1996). Attraction in organizations: A model of workplace romance. *Journal of Organizational Behavior*, 17(1), 5–32. [https://doi.org/10.1002/\(SICI\)1099-1379\(199601\)17:1<5::AID-JOB734>3.0.CO;2-E](https://doi.org/10.1002/(SICI)1099-1379(199601)17:1<5::AID-JOB734>3.0.CO;2-E); pg. 6.
- 50 Quinn, R. E. (1977). Coping with cupid: The formation, impact, and management of romantic relationships in organizations. *Administrative Science Quarterly*, 22(1), 30–45. <https://doi.org/10.2307/2391744>
- 51 Michelson, G., & Mouly, S. (2000). Rumor and gossip in organizations: A conceptual study. *Management Decision*, 38(5), 339–346. <https://doi.org/10.1108/00251740010340508>
- 52 Quinn, R. E. (1977). Coping with cupid: The formation, impact, and management of romantic relationships in organizations. *Administrative Science Quarterly*, 22(1), 30–45. <https://doi.org/10.2307/2391744>
- 53 Cowan, R. L., & Horan, S. M. (2014). Why are you dating him? Contemporary motives for workplace romances. *Qualitative Research Reports in Communication*, 15(1), 9–16. <https://doi.org/10.1080/17459435.2014.955587>
- 54 Pierce, C. A., Byrne, D., & Aguinis, H. (1996). Attraction in organizations: A model of workplace romance. *Journal of Organizational Behavior*, 17(1), 5–32. [https://doi.org/10.1002/\(SICI\)1099-1379\(199601\)17:1<5::AID-JOB734>3.0.CO;2-E](https://doi.org/10.1002/(SICI)1099-1379(199601)17:1<5::AID-JOB734>3.0.CO;2-E); pg. 6.
- 55 Paul, E. L., & Hayes, K. A. (2002). The casualties of “casual” sex: A qualitative exploration of the phenomenology of college students’ hookups. *Journal of Social and Personal Relationships*, 19(5), 639–651. <https://doi.org/10.1177/0265407502195006>
- 56 Cowan, R. L., & Horan, S. M. (2014). Why are you dating him? Contemporary motives for workplace romances. *Qualitative Research Reports in Communication*, 15(1), 9–16. <https://doi.org/10.1080/17459435.2014.955587>; pg. 14.
- 57 Horan, S. M., & Chory, R. M. (2009). When work and love mix: Perceptions of peers in workplace romances. *Western Journal of Communication*, 73(4), 349–369. <https://doi.org/10.1080/10570310903279042>
- 58 Ibid.
- 59 Malachowski, C. C., Chory, R. M., & Claus, C. J. (2012). Mixing pleasure with work: Employee perceptions of and responses to workplace romance. *Western Journal of Communication*, 76(4), 358–379. <https://doi.org/10.1080/10570314.2012.656215>; pg. 368
- 60 Malachowski, C. C., Chory, R. M., & Claus, C. J. (2012). Mixing pleasure with work: Employee perceptions of and responses to workplace romance. *Western Journal of Communication*, 76(4), 358–379. <https://doi.org/10.1080/10570314.2012.656215>
- 61 Ibid.
- 62 Horan, S. M., & Chory, R. M. (2013). Relational implications of gay and lesbian workplace romances: Understanding trust, deception, and credibility. *Journal of Business Communication*, 50(2), 170–189. <https://doi.org/10.1177/0021943612474993>
- 63 Ibid.; pg. 180
- 64 Salvaggio, A. N., Hopper, J., & Packell, K. M. (2011). Coworker reactions to observing sexual behavior at

- work. *Journal of Managerial Psychology*, 26(7), 604-622. <https://doi.org/10.1108/02683941111164508>
- 65 Salvaggio, A. N., Hopper, J., & Packell, K. M. (2011). Coworker reactions to observing sexual behavior at work. *Journal of Managerial Psychology*, 26(7), 604-622. <https://doi.org/10.1108/02683941111164508>
- 66 Harden Fritz, J. M., & Omdahl, B. L. (Eds.). (2009). *Problematic relationships in the workplace*. Peter Lang.
- 67 Harden Fritz, J. M. (2002). How do I dislike thee? Let me count the ways: Constructing impressions of troublesome others at work. *Management Communication Quarterly*, 15(3), 410-438. <https://doi.org/10.1177/0893318902153004>
- 68 Harden Fritz, J. M. (2009). Typology of troublesome others at work: A follow-up investigation. In J. M. Harden Fritz and B. L. Omdahl (Eds.), *Problematic relationships in the workplace* (pp. 22-46). Peter Lang.
- 69 Ibid.; pg. 31.
- 70 Rayner, C., & Keashly, L. (2005). In S. Fox & P. E. Spector (Eds.), *Counterproductive work behavior: Investigations of actors and targets* (pp. 271-296). American Psychological Association.
- 71 Hodson, R., Roscigno, V. J., & Lopez, S. H. (2006). Chaos and the abuse of power: Workplace bullying in organizational and interactional context. *Work and Occupations*, 33(4), 382-416. <https://doi.org/10.1177/0730888406292885>
- 72 Harden Fritz, J. M. (2009). Typology of troublesome others at work: A follow-up investigation. In J. M. Harden Fritz and B. L. Omdahl (Eds.), *Problematic relationships in the workplace* (pp. 22-46). Peter Lang.
- 73 Tye-Williams, S., & Krone, K. J. (2017). Identifying and re-imagining the paradox of workplace bullying advice. *Journal of Applied Communication Research*, 45(2), 218-235. <https://doi.org/10.1080/00909882.2017.1288291>; pg. 231.
- 74 Harden Fritz, J. M. (2009). Typology of troublesome others at work: A follow-up investigation. In J. M. Harden Fritz and B. L. Omdahl (Eds.), *Problematic relationships in the workplace* (pp. 22-46). Peter Lang.
- 75 Ibid.; pg. 40.

END OF CHAPTER QUIZ

ANSWER KEY

1) E 2) E 3) B 4) D 5) C



14.1 Destructive Relationship Behaviors

LEARNING OUTCOMES

1. Familiarize yourself with the concept of secret testing.
2. Understand the effects of empty apologies.
3. Discuss the challenge of identifying Internet infidelity and emotional infidelity.
4. Explain hurtful messages and reactions to hurtful messages.

Secret Testing

Very often, in relationships, individuals seek to understand the nature or state of their relationship. The most direct way to understand a relationship is to talk about it, but sometimes the timing doesn't seem right. Perhaps it's too soon, or maybe the relational partner is squeamish about talking. Regardless, individuals experience a great deal of uncertainty about the nature of the relationship. Uncertainty also exists when relationships seem to be headed toward termination.

Humans engage in intrapersonal communication in which we think about how our dating partner feels about us or about whether the individual wishes to continue in the relationship. A great deal of time may be spent thinking about how the relationship partner feels. If you have ever called a friend to ask your friend's opinion about how your boyfriend or girlfriend feels about you, then you are engaging in information seeking about your relationship. In the early stages of relationships, the relational partners may not share the same definition of the relationship¹. As a result, one or both relational partners experience uncertainty. Research demonstrates that individuals experiencing uncertainty will work to reduce uncertainty.² As research continued, it was determined that it is taboo to talk directly with a relationship partner about the state-of-the-relationship.³ Consider your own experiences with dating and whether it is comfortable to ask or be asked, "so, where are we? Are we dating exclusively, seeing other people...?" Because of the discomfort of such direct questions, individuals tend to use indirect strategies.

There are seven indirect strategies individuals use to assess the state of their relationship. These indirect strategies are referred to as **secret tests**. Some secret tests actually invoke negative relational strategies such as provoking jealousy, deliberately behaving negatively toward a partner, being overly demanding, intentionally creating distance, and testing a partner through a third party "fidelity check." Many secret tests may result in relational hurt or even relationship termination.

Secret tests are labeled directness, endurance, indirect suggestions, public presentation, separation, third party, and triangle test.

Directness Test

Directness is the least secretive of the strategies and involves asking the relational partner about his/her feelings toward the relationship and commitment to the relationship. Alternatively, an individual might disclose their feelings about the relationship with the hope that the relationship partner will reciprocate. Although this "test" may not feel comfortable at first, it can have positive outcomes and involves open communication. Though employing this test may lead to answers that one may not want to hear, at least information is obtained directly from the relationship partner. Research conducted by Melanie Booth-

Butterfield and Rebecca Chory-Assad⁴ indicates that individuals in more stable relationships are more likely to use this overt strategy.

Endurance Test

Endurance test is another form of secret testing in which the partner is tested by engaging in actions that the partner might perceive to be a cost in the relationship. If the partner remains in the relationship, then it is presumed that the partner is committed to the relationship. Research revealed three types of endurance tests: behaving negatively toward the partner, criticizing oneself to the point of being annoying, and making a request that required the partner to exert a great deal of effort. Because the endurance test involves introducing cost into the relationship, individuals risk tipping the scales, i.e., creating more costs than rewards which social exchange theory tells us may result in relationship dissolution. Melanie Booth-Butterfield and Rebecca Chory-Assad explored secret test use in deteriorating relationships.⁵ Their research revealed that in unstable relationships, any secret test involving behaviors that deviated from what one would normally do in a relationship was associated with a desire for relationship disengagement.

Indirect Suggestions Test

The third form of secret testing is **indirect suggestions**. Indirect suggestions involve joking or hinting about more serious stages of relationships such as marriage or having children. If joking about more serious stages in a relationship is met with laughter, flirting, or intimate touching, then it might be assumed that the partner is interested in pursuing a more serious relationship. Another indirect suggestion comes in the form of increasingly more intimate touch. If the intimate touch is received positively or reciprocated, then it is also assumed that there is a commitment to the relationship.

Presenting the Relationship to Outsiders Test

The fourth form of secret testing involves **presenting the relationship to outsiders** as a relationship in which a mutual commitment is involved. This public presentation is meant to gauge the partner's response. For example, you might change your Facebook status to "in a relationship" to gauge your partner's reaction. Another example is introducing your relationship partner as girlfriend/boyfriend and observing the reaction. This secret test is particularly risky because it may result in a public rejection. The advantage is that it might result in public acceptance.

Separation Test

A fifth secret test is the **separation test**. Have you ever been in the beginning stages of a relationship and found it necessary to travel and hoped that your new relationship would survive the physical distance? At times, individuals intentionally create physical distance to test the strength of the relationship. If the relationship survives a few days of separation, then this is an affirmation that the partner is committed. If the relationship partner does not attempt to make contact during the physical separation, then this may be a sign that there is a less than desirable level of interest.

Third-Party Test

The sixth form of secret testing is **third-party testing**. In this case, one might seek the opinion or insight

from the partner's friends, family members, or coworkers.

Triangle Test

The final form of secret testing is the **triangle test**. This test involves the manipulation of a third person to obtain information about the relationship. A common form of triangle testing is to induce a jealous reaction by mentioning an interested third party. For example, a relationship partner might be told that a classmate was making flirtatious advances in class. The partner's reaction to this information is presumed to be an indicator of the partner's commitment. A "fidelity check" is another form of triangle testing in which a situation is created to allow the partner to "cheat." The partner's reaction is then observed.

In more recent research, Rebecca Chory-Assad and Melanie Booth-Butterfield determined that relationship partners use different strategies when attempting to maintain a relationship than when attempting to end a relationship.⁶ These researchers determined that relationship partners who wish to maintain a relationship when the relationship seems to be coming to an end will use the direct secret test in which the partner is approached directly. On the other hand, individuals who wish to end a relationship will do so by utilizing a secret test such as jealousy. Still, these individuals also report having low self-esteem. They concluded that individuals with low self-esteem might use secret testing as a means to "break up" because they do not have the confidence to talk with the partner directly.

Empty Apologies

Apologies are a necessary part of everyday interactions and important to correcting either intentional or unintentional hurt created in others. Despite the positive aspect of apologizing, it is often difficult to do. If your parents/guardians ever required you to apologize to a sibling, then you may recall the difficulty of uttering the words, "I apologize." Conversely, some individuals use apologies so frequently that the apology becomes meaningless. An apology implies acknowledgment of wrongdoing.⁷

Acknowledgment includes expression of responsibility, conveyance of remorse and direct request for forgiveness. Acknowledgment of wrongdoing should imply that there will be an effort to avoid repeated occurrences of the same behavior. Regardless of the difficulties presented by the need to apologize, the positive aspects must be considered. Apologies have positive benefits such as increased feelings of empathy for the offender⁸ and reducing the consequences for an offender.⁹ Individuals who offer more elaborate apologies receive more favorable evaluation, are blamed less, forgiven more, and liked more by the individuals to whom an apology is made. *Apology Sincerity* influences how the victim feels after the negative event.¹⁰ Apology sincerity may alleviate strong negative emotions, including anger. Sincere apologies may also lead victims to think about conflict less negatively and be less vengeful.

Internet Infidelity

The amount of time spent online by a wide range of people makes the Internet an adequate "meeting place" for relationships of all types. The Internet shrinks our world and enables individuals to find others with similar interests, desirable knowledge (health information, how to clean, the best campgrounds, etc.), and attractive qualities. We might consider that the Internet provides privacy, the ability to interact frequently, and enables close proximity. Research shows that when it comes to Internet infidelity, partners perceive their infidelity to be more acceptable than their partner's infidelity. Also, males find involving/goal-directed acts (making plans, expressing love) as more acceptable than women.¹¹ Because of the murky nature of what constitutes infidelity via the Internet, researchers have worked to define it

accurately. **Internet infidelity** is defined as using “sexual energy of any sort—thoughts, feelings, and behaviors—outside of a committed sexual relationship in such a way that it damages the relationship, and then pretending that this drain in energy will affect neither partner nor the relationship as long as it remains undiscovered.”¹² Partners take a harsher approach to Internet infidelity with their partners than themselves.¹³ Specifically, the researchers concluded that there is a double standard in Internet infidelity. Individuals find the Internet infidelity of their partner to be worse than their Internet infidelity. Also, relational partners use self-motivated rules regarding Internet infidelity and have different expectations for self than for the relationship partner. Internet infidelity led to the murder of Google executive Forrest Hayes who was described as a loving father and husband. Hayes made an unfortunate decision to make contact with Alix Tichelman on SeekingArrangement.com. After meeting with Tichelman several times, she injected him with an overdose of heroin, and he was found dead on his yacht in Santa Cruz’s Craft Harbor the next day. According to the Washington Post, the woman coldly injected him with heroin and simply walked away. Her actions were caught on camera and she is now on trial for.¹⁴

Internet Characteristics Fostering Online Infidelity

Contributing to the ease of forming relationships via the Internet are several characteristics identified through research.^{15,16,17} First, the Internet increases the speed with which messages are sent. Consider the difference in sending messages today in comparison to the early 1990s. Mail and landline phones were the primary means of communicating “quickly.” Widespread use of emails and instant messaging increased the speed with which people could communicate. Reach is another characteristic of the Internet, which enables individuals to establish many more relationships than in the past. Relationships were previously established by those in our immediate vicinity including our hometown, workplace, places for social gatherings, and churches. Now, our computer/smartphone puts us in touch with people all over the world without ever leaving our home. Anonymity (revelation of identity or lack thereof) also opens up opportunities for relationships. Consider the case of Manti Te’o in which anonymity allowed him to be fooled into believing that he had a girlfriend and that she died as the result of leukemia.¹⁸

Finally, interactivity, defined as the ability to send and receive messages and react to these messages, makes the Internet a breeding ground for infidelity. An additional characteristic of the Internet that may deceive individuals into thinking that they are not engaged in infidelity is the lack of physical presence, which makes the issue of infidelity ambiguous. After all, if one is not physically present, how can one cheat?

Research Spotlight



Tony Docan-Morgan and Carol A. Docan set out to examine how men and women view Internet infidelity in a 2007 study. The researchers started by having 43 undergraduates list what they thought could be Internet infidelity. The researchers reviewed the open-ended responses and paired down the list to the following:

- having cybersex (engaging in sexually explicit conversations with someone online)
- flirtatious behavior (flirting with someone they met online)
- emotional (developing an emotional connection with someone online)
- seeking another (posting a personal ad online)
- conversing with another (having a conversation with someone online)
- exchanging information (giving personal information about yourself online – e.g., email address, cellphone number).

- other (engaging in casual conversational topics, not relational or emotional ones)

Based on these six categories and other literature on the subject, the researchers developed a measure and narrowed it down to 27 items. The measure ultimately discovered two different patterns of Internet infidelity *superficial/informal acts* (e.g., chatting about sports, talking about current events, joking) and *involving/goal-directed* (e.g., disclosing love, viewing personal ads, making plans to meet someone).

The researchers found that superficial/informal acts were rated as less severe than involving/goal-directed ones. When it came to the severity of superficial/informal acts, there were no differences between females and males in this study. However, females did find involving/goal-directed Internet infidelity as more severe than did men. Lastly, the researchers found that people tended to rate their Internet infidelity as less severe than they rated their partner's infidelity on both involving/goal-directed and superficial/informal acts.

Docan-Morgan, T., & Docan, C. (2007). Internet infidelity: Double standards and the differing views of women and men. *Communication Quarterly*, 55(3), 317-342. <https://doi.org/10.1080/01463370701492519>

Emotional vs. Sexual Infidelity

The lack of physical presence in online relationships drives the need to differentiate between sexual infidelity and emotional infidelity. It seems clear that physical interaction with another individual constitutes sexual infidelity. Still, some individuals might say that as long as there is no sexual intercourse, then there has been no infidelity. If we can't all agree on when cheating has occurred after physical contact, then it is easy to see why there tends to be a great deal of disagreement as to what constitutes emotional infidelity. One might even question whether emotional attachment to an infidel outside of one's primary relationship constitutes infidelity at all. Sexual infidelity involves sexual intimacy and physical involvement. In contrast, emotional infidelity includes "emotional involvement with another person, which leads one's partner to channel emotional resources such as romantic love, time, and attention to someone else."¹⁹ For example, if you receive a promotion at work, it might be assumed that the first person you would tell would be your relational partner. However, if emotional resources have been directed toward another individual, then this individual may be the first individual you might call. The relationship partner might view this as a betrayal or a dependence on another individual at the very least.

It was initially proposed that women would perceive emotional infidelity as worse than sexual infidelity and that men would perceive sexual infidelity in their partners as worse than emotional infidelity. This proposal developed from the evolutionary psychology perspective. In summary, this perspective indicates that males would be concerned with sexual infidelity because they had no way of knowing whether their mate was carrying their child and thus carrying on their genetic material. On the other hand, women were more concerned with emotional infidelity because women feared that their male counterparts would become attached to another female and that his resources (e.g., money, time) would be directed toward the other. Although this perspective provides insight into the basic differences between perspectives that might be held by females and males, research consistently shows that both females and males find sexual infidelity to be worse than emotional infidelity.²⁰

Researchers reported that sexual infidelity occurred in 30% to 40% of relationships.²¹ When sexual infidelity occurs, research shows that how infidelity is discovered determines relational outcomes.²² Voluntary admission seems to result in increased forgiveness, less likelihood of dissolution, and was the least damaging to relational quality.

Hurtful Messages

“Even in the closest, most satisfying relationships, people sometimes say things that hurt each other.”²³ We have all been in the position of having our feelings hurt or hurting the feelings of another. When feelings are hurt, individuals respond in many different ways. Though hurtful messages have existed since humans began interacting, it was in 1994 that Anita L. Vangelisti first developed a typology of hurtful messages. Her work resulted in ten types of messages.²⁴ She furthered her work by exploring reactions to hurtful messages. First, we will discuss her typology of hurtful messages, and then we will address how individuals respond to hurtful messages.

Types of Hurtful Messages

Evaluations

Evaluations are messages that assess value or worth. These messages are a negative assessment of the other individual that result in hurt. One of the coauthors was once riding in a car with a coworker and his wife. He was driving and made an error. She said, “You are the worst driver ever.” The moment was awkward for everyone.

Accusation

The second type of hurtful message is an accusation. Accusations are an assignment of fault or blame. Any number of topics can be addressed in accusations. A common source of conflict in relationships is money. An example of an accusation that might arise for conflict over money is “You are the reason this family is in constant financial turmoil.”

Directives

Directives are the third type of hurtful message, and involve an order or a command. “Go to hell” is a common directive in some relationships depicted in movies and television, but is a more extreme example. In everyday interaction, examples might include, “leave me alone,” “don’t ever call me again,” or “stay away from me.” One of the coauthors remembers a short-lived relationship in which she called her boyfriend’s house. The boyfriend had told his mother that he was out with her. The phone call to his house ultimately resulted in the boyfriend being punished for lying, but he relayed a potentially hurtful message to the coauthor, which was, “Don’t ever call my house unless I ask you to.” As noted, the relationship was short-lived, but the hurtful message indicating a lack of value for the coauthor’s feelings still stings.

Informative Statements

Informative statements are hurtful messages that reveal unwanted information. A supervisor might reveal the following to an employee: “I only hired you because the owner made me.” Siblings might reveal “I never wanted a younger sister” or “When Mother was dying, she told me I was her favorite.” Friends might say something like, “When you got a job at the same place as me, I felt smothered.” Informative messages reveal information that could easily be kept a secret, but are intended to hurt.

Statement of Desire

A statement of desire expresses an individual's preference. A romantic partner might state, "the night I met you, I was more interested in your friend and really wanted to go out with him." A friend might say, "Callie has always been a better friend than you." A parent/guardian with multiple children might state, "God only gives you one good child."

Advising Statement

An advising statement calls for a course of action such as "you need to get yourself some help." One of the coauthors inadvertently communicated an advising statement when a friend was talking about going on so many interviews and not getting hired. The coauthor said, "There are courses that offer interview training. You could take a course in interviewing." The statement hurt the coauthor's friend as she was only seeking comfort and not advice that seemingly indicated she had poor interview skills.

Question

A question is another type of hurtful message which, when asked, implies something negative. A very direct hurtful question is, "What is wrong with you?" Another subtler question that might be perceived as hurtful is, "You've been at the bank for ten years. Have you been promoted yet?"

Threats

Threats are messages that indicate a desire to inflict harm. Harm can be physical or psychological. For example, a romantic partner might say, "if you go out with your friends tonight, I'm going to break up with you." A direct physical threat is a statement directed toward inflicting bodily harm such as, "I'm going to knock the crap out of you if you don't change out of that outfit."

Jokes

Jokes are another type of hurtful message that involves a prank or witticism. For example, a cousin might say to his athletically built female cousin, "what's up quarterback thighs?" implying that the female's looks are masculine. In an organization, a coworker could jokingly comment to a supervisor on the supervisor's relationship with a subordinate, "I can see who's really in charge here." A prank can be hurtful if it results in humiliating or embarrassing the object of the prank. Pranks are sometimes carried too far. *The Breakfast Club* includes a perfect example of a prank carried too far when the jock explains that he and his wrestling buddies duct-taped the butt cheeks of a nerd. It was meant to be funny, but results in physical injury to the nerd. Jokes in the form of witticism are often open to interpretation, but hurt may result if the recipient feels that the sender intended to hurt more so than humor. Pranks that embarrass or cause physical harm often create emotional pain for the recipient.

Lies

Lies are deceptive speech acts that result in the hurt of the recipient. In an episode of *The King of Queens*, Doug tells his wife Carrie that her forehead is too big after she hurt his feelings. He didn't really feel that way, but his words resulted in Carrie trying to cover her forehead because she was embarrassed that her forehead was "too big." Lies can range from the mundane such as "I was late for dinner because I was on the phone with my boss." to "I'm going to San Diego on business." Lies, when discovered, may result in feelings of being disrespected or betrayal.

Reactions to Hurtful Messages

After exploring the types of hurtful messages that exist, Anita Vangelisti and Linda Crumley investigated the reactions individuals have to hurtful messages.²⁵ The results of Vangelisti's and Crumley's investigation revealed three broad categories of reactions: active verbal responses, acquiescent responses, and invulnerable responses.

Active verbal responses involve attacking the other, defending the self, and asking for an explanation. Suppose that you and a romantic partner go to friends for dinner. Upon entering the home, you take off your shoes. Your romantic partner poses a hurtful question, such as "what is wrong with you? What kind of guest takes off their shoes?" An active verbal response that attacks the other is "nothing is wrong with me. What's wrong with you, you idiot? Everybody knows wearing street shoes bring in germs and allergens." Alternatively, one might respond by saying, "nothing is wrong with me. It is perfectly normal to take one's shoes off when entering another person's home." Finally, one might ask for an explanation, such as "Why do you think there is something wrong with me?"

Acquiescent responses involve crying, conceding, or apologizing. This type of response demonstrates that the message is hurtful or that the recipient believes they have engaged in some wrongdoing. For example, if a friend says, "I never want to see you again," a conceding response might be, "that's fine. I won't bother you anymore." Alternatively, an apologetic response is, "I am so sorry. Is there something I can do to change your mind?"

Finally, hurtful messages can result in invulnerable responses. We have all heard the phrase "sticks and stones may hurt my bones, but words will never hurt me." This phrase, while not true, does demonstrate a desire to demonstrate invulnerability. Reactions of invulnerability range from ignoring the message to laughing. Recall the example from the directive message earlier in which one of the coauthors was told not to call the boyfriend's house. Although the coauthor felt that the message was disrespectful, the response was to laugh. The boyfriend was told that his "directive" was ridiculous and that if she was going to be used as an excuse, then he should be smart enough to let her in on that little secret unless he was lying to her, too.

Key Takeaways

- Because it is considered taboo to ask one's relational partner about the nature of the relationship, one or both relational partners may use secret tests.
- Inherent characteristics of the Internet may facilitate infidelity.
- Emotional infidelity is particularly challenging because relationship partners may not agree on what constitutes infidelity.
- Hurtful messages are a part of the human experience, but they can be avoided by becoming aware of the types of messages that exist.

Exercises

- Review the types of secret tests. For each type, provide an example from your own life in which you have engaged in the secret test or observed a friend doing so. For each example, state whether you believe the secret test was helpful or harmful and why.

- Create your definition of emotional infidelity. Ask three friends to come up with their definition of emotional infidelity. Compare and contrast the four definitions.
- After reading the section on Internet infidelity and Internet characteristics, find your example in the popular media that relates to one of the characteristics of the Internet that seems to facilitate infidelity. For example, you might choose the characteristic “speed.” Find an article in the popular media in which speed played a role in an individual’s ability to “cheat” in the virtual environment.
- Working in a group, create an example of each type of hurtful message from your own life that you have experienced or witnessed. What was the reaction? Label the reaction according to Vangelisti and Crumley’s Reaction Types.

14.2 The Dark Side of Relationships: Aggression

LEARNING OUTCOMES

1. Explain relational aggression.
2. Explore relational aggression among women.
3. Define and explain the term “verbal aggression.”
4. Describe bullying and bullying in the workplace.
5. Explain basic strategies for handling the dark side of interpersonal communication.

Relational Aggression

Relational aggression is defined as behaviors that harm others.²⁶ Harm is created through damaging social relationships or feelings of acceptance. Research on relational aggression indicates that it involves both confrontational and nonconfrontational behaviors. Specific behaviors associated with *confrontation*, or direct behavior, include name-calling, cruel teasing, ridicule, and verbal rejection directed at the target. *Nonconfrontational* or indirect behaviors include spreading rumors, gossiping, and social manipulation.^{27,28} Adolescents use indirect aggression more than direct aggression to harm relationships.

Relationally Aggressive Categories

When researching 11 to 13-year-olds, five categories of relationally aggressive behaviors were identified.²⁹ The categories are labeled inconsistent friendships, rumors/gossip, excluding/ditching friends, social intimidation, and notes/technological aggression. Additional research identified seven types of relationally aggressive behaviors among high school girls.³⁰ Based on open-ended descriptions from high school girls, the following categories of relational aggression were found: the physical threat/physical attack, rejection, humiliation, betrayal, personal attack, boy manipulation, and relational depreciation. In addition to the categories of relationship aggression, it is essential to note that gossiping and spreading rumors were the most common forms of relational aggression across age groups.^{31,32}

Relational Aggression in College: Bad and Normal

Current research indicates that relational aggression begins in childhood and extends into the workplace. Maintaining an awareness of this tendency may help to avoid this situation in the future. A challenge with relational aggression among women is that it is known to be negative and yet labeled as normal.^{33,34,35,36,37} Evidence of this dual perspective on relational aggression among women is found within the media in movies such as *Mean Girls* (also a Broadway musical). Because of the acceptance of this behavior as negative and normal, conversations were held with women to understand their explanation for engaging in negative behavior. Through these conversations, several themes emerged. These themes included (a) girls will be girls; (b) relational aggression as venting; (c) blaming the victim; (d) minimizing their role; and (e) regret. The “girls will be girls” theme is especially problematic because it indicates that women know that relational aggression has negative consequences, but they accept it as normal. Researchers report that college-aged women when discussing relational aggression made such statements as “something you expect [among women], drama and gossip and cattiness” and “typical girl stuff.” They concluded that women continue to engage in relational aggression because it is perceived to be normal. In other words, it is acceptable because everyone is doing it.³⁸

The second theme that emerged in discussions of relational aggression among college-aged women was relational aggression as venting. Women regularly described gossiping, name-calling and talking behind someone’s back as cathartic in nature. It was described as a form of stress relief. It was concluded that women view this form of communication as acceptable because it is beneficial. This “excuse” makes it okay to vent to other women even if it might be harmful if discovered by the target.³⁹

The third theme among women discussing relational aggression was “blaming the victim.” The majority of women reported that the targets were to blame for the relationally aggressive behavior because they were either “crazy” or engaged in sexually inappropriate behavior. Other reasons given were that the target was either mean to them first or “different.” For example, one girl reported targeting her roommate, whom she knew to be mentally ill. She blamed the girl by stating that the girl should have taken her medicine more regularly to control her behavior better. Additionally, the majority of women in their study stated that they engage in relational aggression because the target engaged in inappropriate sexual behavior.

A fourth theme related to relational aggression emerged in which women attempted to minimize their role. Study participants mainly reported that they were simply going along with the actual perpetrator and acted as an audience member. Individuals described themselves as listeners rather than being the real aggressor. Another way in which women attempted to minimize their role was to compare their behaviors to others. This comparison served to demonstrate that their behavior was not as aggressive as that of others.

Finally, women discussed feeling regret for having behaved in a relationally aggressive manner. Though the women did express regret, their regret was generally paired with blaming the victim. For example, participants acknowledged that they felt bad for behaving as they did even though the target was crazy.

Verbal Aggression

Defining Verbal Aggression

Verbal aggression is defined as communication that attacks an individual’s self-concept intending to create psychological pain. If you have ever had an argument and been called a name or been putdown,

then you have been the target of verbal aggression.⁴⁰ Verbal aggression is considered a destructive form of communication. Because verbal aggression is regarded as a negative form of communication, researchers have worked to determine characteristics that may increase the likelihood of individuals behaving in an aggressive manner. Researchers found that six dimensions of self-esteem (defensive self-enhancement, moral self-approval, lovability, likability, self-control, and identity integration) were significantly and negatively related to trait verbal aggressiveness.⁴¹ History of familial verbal aggression was positively associated with the perceived acceptability of verbal aggression against a romantic partner, and this association was stronger for individuals with higher behavioral inhibition system scores. Individuals with high behavioral inhibition are more likely to be anxious and react nervously when facing punishment. In other words, people who have been exposed to verbal aggression are more likely to find it acceptable to engage in verbal aggression against a relational partner, especially when the individual also scores high in behavioral inhibition. Also, individuals who score high in behavioral inhibition are more likely to find verbal aggression to be acceptable regardless of whether they have been exposed to verbal aggression in the past.⁴²

Perceptions of Verbal Aggression

If your parents/guardians ever told you that it wasn't what you said, it was the way you said it, then they were offering you sage advice. Research shows that when engaged in interpersonal disputes, smaller amounts of verbal aggression were perceived when the affirming communicator style (relaxed, friendly, and attentive) was used.⁴³ Thus the communicator's style of communication impacted the perception of the message. Table 14.1 provides a list of the ten most common examples of verbally aggressive messages.⁴⁴

Type of Message	Example
Character Attacks	You're a lying jerk!
Competence Attacks	You're too stupid to manage our finances.
Background Attacks	You don't even have a college degree!
Physical Appearance	You are as fat as a pig!
Maledictions	I wish you were dead.
Teasing	Your hair color makes you look like a clown.
Ridicule	Your nose looks like a beak.
Threats	I'll leave you and you won't have a dime to your name.
Swearing	Go to _____!
Nonverbal Emblems	shaking fists, "flipping off"

Table 14.1 Verbally Aggressive Messages

Bullying

Bullying is a form of communication in which an aggressive individual targets an individual who is perceived to be weaker. **Bullying** is a form of aggressive behavior in which a person of greater power attempts to inflict harm or discomfort on individuals. This definition also indicates that the behavior is repeated over time.⁴⁵ For example, a child might call his friend an idiot on the playground one day. A single incident of name-calling would not be considered bullying, but if it happened day after day, then

the name-calling would be considered bullying. You may have been bullied or known someone who was bullied. It is also possible that you bullied someone. Bullies use their authority, size or power to create fear in others. Bullying is known to have negative consequences, such as dropping out of school. It was found that the actions of bullies leave their victims feeling helpless, anxious, and depressed.⁴⁶ Other researchers report three types of bullying: physical, verbal, and relational.⁴⁷

Physical Bullying

Physical bullying involves hitting, kicking, pulling hair, strapping a female’s bra strap or giving a “wedgie.” Witnesses easily observe this type of bully. You may recall being the victim of these behaviors, engaging in these behaviors, or watching others engage in these behaviors. Physical bullying can be prevented by observers, such as teachers or even peers. There are several Public Service Campaigns directed toward bystanders to let the bystander know that they can help prevent or stop bullying. However, bullies may corner their victims in a more private setting, knowing that the weaker individual will not be able to defend themselves.

Relational Bullying

The second type of bullying is indirect or **relational bully**. This form of bullying is the manipulation of social relationships to inflict hurt upon another individual.⁴⁸ This type of bullying includes either withholding friendship or excluding. Relational bullying often increases as children age because physical bullying decreases. Relational bullying is particularly problematic because it is very painful for victims, but cannot be readily observed. One might wonder what a teacher or parent/guardian might do when two friends suddenly begin to exclude a third friend. The rejection is so painful, but it seems nearly impossible to require adolescents to continue liking and including the rejected child. An interesting finding in relation to this type of bullying is that females are more likely to engage in this form of bullying.⁴⁹

Verbal Bullying

The third type of bullying is **verbal bullying** and includes threats, degrading comments, teasing, name-calling, putdown, or sarcastic comments.⁵⁰ This form of bullying is easily observed as well and can be prevented by authorities and peers. The effects of this form of bullying are similar to the impact of physical and relational



Figure 14.6 Consequences of Bullying

bullying.

The negative consequences of childhood bullying have driven communication scholars to develop educational tools to provide to teachers and other authority figures. Researchers developed a model to assist teachers in discerning playful, prosocial teasing from destructive bullying.⁵¹ The Teasing Totter Model outlines behaviors that range from prosocial teasing to bullying and offers recommendations for responding to each. Teasing in a prosocial manner is usually done among friends, laughter is involved and even affection. Bullying, on the other hand, is a repeated negative behavior in which the victim is visibly distressed. There is a clear power difference in size, age, or ability.

Cyberbullying

The inherent ease of using the Internet and communicating via the Internet has created an excellent and convenient venue for bullying. **Cyberbullying** is intentional harm inflicted through the medium of electronics that is repeated over time.⁵² Cyberbullying affects victims academically and socially with 20% of victims reporting Internet avoidance.⁵³ When using electronic communication technologies, young people are exposed to interpersonal violence, social aggression, harassment, and mistreatment.⁵⁴ Cyberbullying includes behaviors such as flaming, which involves posting provocative or abusive posts, and outing where personal information is posted.⁵⁵ Cyberbullying is so prevalent that social media such as Facebook have policies to help users avoid this phenomenon. Consider how often you engage with your peers through social media versus your counterparts who were teenagers/young adults in the 1980s. Opportunities for communicating with peers were limited to FtF or via landline phones. Thus opportunities for bullying could be confined to school or landline phones such that bullying was limited to eight hour school days and phone calls that could be ended immediately upon becoming uncomfortable. Now, there is no end to when bullying can take place. Cyberbullying can take place 24/7, and the only way to avoid it is to cut off a major from of staying connected with one's world via cell phone or Internet. Researchers are just now beginning to understand the impact of cyberbullying, and some

Discovering Self-Concept - Who are you?

What should I do if I'm being bullied, harassed or attacked by someone on Facebook?

Facebook offers these tools to help you deal with bullying and harassment. Depending on the seriousness of the situation:

Unfriend — Only your Facebook friends can contact you through Facebook chat or post messages on your Timeline.

Block — This will prevent the person from starting chats and messages with you, adding you as a friend and viewing things you share on your Timeline.

Report the person or any abusive things they post.

The best protection against bullying is to learn how to recognize it and how to stop it. Here are some tips about what you should — and shouldn't — do:

Don't respond. Typically, bullies want to get a response — don't give them one.

Don't keep it a secret. Use Facebook's Trusted Friend tool to send a copy of the abusive content to someone you trust who can help you deal with the bullying. This will also generate a report to Facebook.

Document and save. If the attacks persist, you may need to report the activity to an ISP and they will want to see the messages.

Visit Facebook's Family Safety Center for more information, tools and resources. <https://www.facebook.com/help/116326365118751/>

speculate that cyberbullying is worse than traditional bullying, but research shows mixed results on this assertion.



Research Spotlight

In 2013, Anke Görzig and Kjartan Ólafsson set out to determine what makes a bully a cyberbully. They recruited 1,000 Internet-using children aged 9–16 in 25 European countries. The researchers also interviewed at least one of the children’s parents for the study. The total sample size was 25,142.

The questionnaire the researchers used was translated into 25 different languages. The interviews took place in the children’s home. Any sensitive questions were asked on a private questionnaire. As you can see, this project was a massive undertaking.

Of the 25,142 participants, 2,821 admitted to engaging in behaviors either online or FtF that could be labeled as bullying.

The researchers found that “cyberbullies (all else being equal) were at least four times as likely to engage in risky online activities and twice as likely to spend more time online as well as finding it easier to be themselves online.”⁵⁶ Furthermore, the researchers found that girls were more likely to engage in cyberbullying than FtF bullying when compared to their male counterparts.

Görzig, A., & Ólafsson, K. (2013). What makes a bully a cyberbully? Unravelling the characteristics of cyberbullies across 25 European countries. *Journal of Children & Media*, 7(1), 9-27. <https://doi.org/10.1080/17482798.2012.739756>

Workplace Bullying Typology

Though it is hard to imagine among adults, bullying continues in the work environment. Bully can lead to loss of employment, poor attendance and depression. There are several typologies of bullying. In research conducted with nurses, a typology of bullying was created that is particularly comprehensive.⁵⁷ The typology of these researchers includes the bullying behavior and related tactics. **Workplace bullying behaviors** involve those seen in Table 14.2. As you can see, workplace bullying behaviors involve a wide range of tactics.

Behaviors	Tactics
Isolation and exclusion	
	Being ignored Being excluded from conversation Being isolated from supportive peers Being excluded from activities
Intimidation and Threats	
	Raised voices or raised hands Being stared at, watched and followed Tampering with or destroying personal belongings Compromising or obstructing patient care
Verbal threats	

	Being singled out, scrutinized and monitored
	Being yelled at or verbally abused
	Being stood over, pushed or shoved
	Belittlement and humiliation
	Verbal put-downs, insults or humiliation
	Spreading gossip
	Being given a denigrating nickname
	Blamed, made to feel stupid or incompetent
	Suggestions of madness and mental instability
	Mistakes highlighted publicly
Damaging Professional Identity	
	Public denigration of ability or achievements
	Questioning skills and ability
	Being given demeaning work
	Unsubstantiated negative performance claims
	Spreading rumors, slander, and character slurs
	Questioning competence or credentials
Limiting career Opportunities	
	Denial of opportunities that lead to promotion
	Being overlooked for promotion
	Excluded from committees and activities
	Exclusion from educational opportunities
	Rostered to erode specialist skills
Obstructing work or making work-life difficult	
	Relocation to make job difficult
	Removal of administrative support
	Excluded from routine information
	Work organized to isolate
	Removal of necessary equipment
	Given excessive or unreasonable workload
	Sabotaging or hampering work
	Varying targets and deadlines
	Excessive scrutiny of work
Denial of due process and natural justice	

Denial of due process in meetings
Denial of meal breaks
Compiling unsubstantiated Written records
Denial of sick, study or conference leave
Unfair rostering practices
Economic sanctions
Roster to lower-paid shift work
Limiting the opportunity to work
Dismissal from position
Reclassifying position to lower status

Table 14.2 Bullying in the Workplace: Behaviors and Tactics

Communicating Effectively

Relationships involve work! Media portrays relationships as romantic endeavors, and the darker side of relationships remains buried. In real-life, individuals may be inclined to hide relationship difficulties, which further perpetuates the notion that relationships simply happen and that everyone lives happily ever after.

Communicating Anger

Research repeatedly demonstrates that how emotion is communicated will affect the outcome of the communication situation. Relationship partners are more satisfied when positive emotions are communicated rather than negative emotions. Four forms of anger expression have been identified.⁵⁸ The four forms of anger expression range from direct and nonthreatening to avoidance and denial of angry feelings. Anger expression is more productive when the emotion is communicated directly and in a nonthreatening manner. In most circumstances, direct communication is more constructive.

Form of Expression	Explanation of Form
Assertion	Direct statements, nonthreatening, explaining anger
Aggression	Direct and threatening, may involve criticism
Passive Aggression	Indirectly communicate negative affect in a destructive manner - “the silent treatment”
Avoidance	Avoiding the issue, denying angry feelings, pretending not to feel anything

Table 14.3 Forms of Anger Expression

Affirming Communicator Style

When communicating with one’s relational partner, adopting an affirming communicator style may lead to positive outcomes. The affirming communicator style was initially conceptualized to involve friendly, relaxed, and attentive behaviors.⁵⁹ The friendly communicator style involves encouraging others,

acknowledging others' contributions, and being tactful in communication with others. The relaxed style involves being calm and collected while avoiding nervous mannerisms that indicate that one is tense. Being attentive involves listening carefully to others and demonstrating an empathic approach to others. Research has demonstrated that the affirming communicator style causes receivers to perceive that there is less verbal aggression.⁶⁰

Deception

One final aspect of the dark side of interpersonal communication to be considered is deceptive communication. We are all familiar with the concept of lying and deception. We are taught from a young age that we should not lie, but we often witness the very people instructing us not to lie engaging in “little white lies” or socially acceptable lies. As communication scholars, we must distinguish between a lie that is told for the benefit of the receiver and a lie that is told with more malicious intent. Lies told with more malicious intent are referred to as deception and are the focus of this section. Judee Burgoon and David Buller define deception as, “a deliberate act perpetuated by a sender to engender in a receiver beliefs contrary to what the sender believes is true to put the receiver at a disadvantage.”⁶¹ Deceptive communication can exist in any type of relationship and in any context. H. Dan O’Hair and Michael Cody discuss deception as a common message strategy that is used in a manner similar to other forms of communication.⁶² They state that deception is often purposeful, goal-directed, and can be used as a relational control device. We will begin our discussion of deception by exploring three types of deception. This discussion will be followed by exploring the work of Jennifer Guthrie and Adrienne Kunkel, who discussed why romantic partners use deception and how often.⁶³

Types of Deception

Three types of deception are discussed in the field of communication: falsification, concealment, and equivocation.⁶⁴ Falsification is when a source deliberately presents information that is false or fraudulent. For example, the source of deception may state, “I did not drink when I went out last night,” even though the source did drink. Researchers have found that falsification is the most common form of deception.

Concealment is another form of deception in which the source deliberately withholds information. For example, if two partners are living in two different states and one partner is offered a job in the same state as the other partner, but the job offer is not revealed to the other partner, then concealment has occurred. Consider the consequences of concealment in this situation. By failing to reveal the job offer, the source is preventing the receiver from operating with all of the known facts. For example, a decision to remain in a long-distance relationship might be affected if one partner is not willing to take a job that will mean living in the same state.

The third form of deception is referred to as equivocation. This form of deception represents a moral grey area for some because some see equivocation as a clear lie. Equivocation is a statement that could be interpreted as having more than one meaning. For example, you ask your romantic partner if she talked to her ex-boyfriend last night, and she says, “no, I didn’t talk to him,” but she did text with him, then an equivocation has occurred. Technically, the statement, “I did not talk to him” is true, but only technically because communication did occur in a different form. Consider how the answer may have been changed if the question was, “Did you communicate with your ex-boyfriend last night?” Now that we have discussed what deception is and several types of deception, we can examine how deception functions in romantic relationships.

Lies in Romantic Relationships

Jennifer Guthrie and Adrienne Kunkel explored the reasons why romantic partners engage in deception in their article titled “Tell Me Sweet (And Not-So-Sweet) Little Lies: Deception in Romantic Relationships.”⁶⁵ The researchers asked 67 college students to record their deceptive communication in diaries for seven days. At the end of seven days, the students returned their diaries. The researchers counted the deceptive communication acts in all of the diaries and determined that the 67 students produced 327 deceptive acts in a seven-day period. The results of this part of their study showed that 147 of the deceptive acts were lies, 61 were exaggerations, half-truths accounted for 56 of the deceptive acts, 35 of the deceptive acts were diversionary responses, 26 were secrets, and two uses of deception were not able to be categorized due to lack of detail in the diary. On average, each participant engaged in 4.88 deceptive acts in seven days.

In addition to studying how often participants lied, Guthrie and Kunkel⁶⁶ were interested in why the students lied. The students provided 334 reasons for the 327 deceptive acts that they reported. The researchers were able to place the 334 reasons into six overarching motives for lying: engaging in relational maintenance, managing face needs, negotiating dialectical tensions, establishing relational control, continuing previous deception, and unknown. In the table that follows, each motive for deception is broken down further.

Managing Face Needs

Supporting Positive Face

Supporting own and/or partner’s positive face (protecting partner’s feelings and self-presentation)

Supporting Negative Face

Supporting own and/or partner’s negative face (avoiding unwanted activities and/or imposition)

Negotiating Dialectical Tensions

Balancing Autonomy/Connection

Balancing the need for independence versus the need for togetherness

Balancing Openness/Closedness

Balancing the need for open communication versus the need for privacy

Balancing Novelty/Predictability

Balancing the need for spontaneity versus the need for routine or expected behaviors

Establishing Relational Control

Acting Coercive

Ensuring partner behaves or feels how partner wants them to

Continuing Previous Deception

Participants indicated that they had lied about something in the past and the particular act of deception was a way of continuing or maintaining the lie

Unknown

Participants reported that they could not identify their motives for using deception

Table 14.4. Deceptive Acts

Through this exploration of the frequency of lies and motives for doing so, Guthrie and Kunkel uncovered an important finding. The students in the study responded positively to examining their deceptive acts. They also discovered that students held inaccurate perceptions of their use of deception and either under-reported or over-reported how often they engaged in deception. The researchers concluded that reflecting upon deception will allow individuals to understand how deception impacts relationships in both positive and negative ways. Awareness seems to be key to managing deception in romantic relationships.

Domestic Violence or Intimate Partner Violence

“Domestic violence is the willful intimidation, physical assault, battery, sexual assault, and/or other abusive behavior as part of a systematic pattern of power and control perpetrated by one intimate partner against another. It includes physical violence, sexual violence, threats, and emotional/psychological abuse.”⁶⁷ The Center for Disease Control (CDC) expands upon this definition and labels domestic violence as “intimate partner violence.”⁶⁸ These include sexual violence, stalking, physical violence, and psychological aggression. The National Intimate Partner and Sexual Violence Survey (NISVS), an intimate partner is described as a romantic or sexual partner and includes spouses, boyfriends, girlfriends, people with whom they dated, were seeing, or “hooked up.”

According to the *NISVS 2015 Data Brief*, one in three were victims of contact sexual violence, physical violence, and/or stalking by an intimate partner during their lifetime.⁶⁹ One in four (30 million) women and one in ten (12.1 million) men reported intimate partner violence-related impact which includes being fearful, concerned for safety, injury, need for medical care, needed help from law enforcement, missed at least one day of work, missed at least one day of school, any post-traumatic stress disorder symptoms, need for housing services, need for victim advocate services, need for legal services and contacting a crisis hotline.

Sexual violence is a specific form of domestic violence that may be experienced by women and men and includes rape, which can consist of being forcibly penetrated (or penetrating) someone else, sexual coercion, and unwanted sexual contact.⁷⁰

The CDC considers an individual to be a stalking victim if they “experienced multiple stalking tactics or a single stalking tactic multiple times by the same perpetrator and felt very fearful, or believed that they or someone close to them would be harmed or killed as a result of the perpetrator’s behavior.”⁷¹

The following behaviors are considered to be stalking by the CDC:

- Unwanted phone calls, voice or text messages, hang-ups
- Unwanted emails, instant messages, messages through social media
- Unwanted cards, letters, flowers, or presents
- Watching or following from a distance, spying with a listening device, camera, or global positioning system (GPS)
- Approaching or showing up in places, such as the victim’s home, workplace, or school when it was unwanted
- Leaving strange or potentially threatening items for the victim to find
- Sneaking into the victim’s home or car and doing things to scare the victim or let the victim know the perpetrator had been there

In follow-up questions, respondents who were identified as possible stalking victims were asked about

their experiences with two additional tactics:

- Damaged personal property or belongings, such as in their home or car
- Made threats of physical harm

Sally Fiona Kelly explored aggression concerning violent sentiments.⁷² In her study, she sought to understand why individuals engaged in violent behavior. Her study demonstrates that individuals who have committed violent acts in a relationship believe violence is acceptable and are prepared to use violence. This finding suggests that one approach to reducing violence is to focus on changing beliefs and thoughts associated with violence. Strategic communication scholars can create campaigns to target beliefs related to violence. In a similar study, participants predicted that women would become more aggressive while watching videos of males and females in conflict. When watching videos of “fighting” couples, males predicted the conflict would lead to increasing levels of aggression more often than females. Male participants also recommended the use of more aggressive behaviors during conflict.⁷³ Thus this study underscores the change perceptions of the acceptability of aggressive behavior. This same study assessed participant’s perceptions of the likelihood of conciliatory strategies on the part of the individuals in fights. Participants in the study believe the chance of forgiveness and resolution decreased as conflict increase. In light of this finding, relational partners should apologize and forgive earlier in conflict to reduce escalation that may increase the chance of violence.

Being Mindful

Gaining an awareness of destructive communication behaviors in relationships may help avoid the emotional consequences of destructive communication as well as the loss of a relationship. Individuals engage in information seeking strategies to gain insight into the current state-of-the-relationship. As discussed earlier in this chapter, one such strategy is secret testing. This strategy ranges from the not so secretive “direct” secret test to the entrapping “triangle test.” Other secret tests involve endurance, indirect suggestions, public presentation, separation, and third-party testing. Although secret tests may allow relationship partners to understand their relationship through subtle and sometimes overt information seeking, the direct approach seems to be the one that relationship partners use when they wish to maintain the relationship.

Relational aggression is a harmful form of behavior that serves to either withhold friendship or manipulate the social relationships of another individual. This form of behavior is particularly prevalent among females and begins in early childhood and continues into the workplace. The consequences of relational aggression are emotional pain and withdrawal.

Verbal aggression is a communication strategy in which the self-concept is attacked rather than arguing about the issues of a controversial topic. The impact of verbal aggression can be lessened if the communicator used an affirming style of communication. Bullying is similar to verbal aggression and relational aggression. Bullying is a destructive form of communication in which the aggressor targets an individual who is weaker either in strength, size, or ability. The effects of bullying can range from relatively mild (hurt feelings) to devastating (successful suicide attempts).

One cannot wholly escape the possibility of becoming a victim of the darker side of communication. Still, individuals can work to avoid engaging in the behaviors associated with the dark side of communication. To do so, consider adopting an affirming style of communication, focusing on the topic during arguments rather than the self-concept of others, and working to prevent bullying when it is

observed in others. Also, relational aggression can be avoided by refusing to engage in the behavior and refusing to participate when others are doing so. In particular, we should not simply accept that relational aggression is a natural occurrence among females. Finally, talk with your partner about their beliefs concerning aggressive behavior and violence to make sure your partner does not believe violence is an acceptable means of dealing with conflict.

Key Takeaways

- Relational Aggression is a hurtful form of communication which manipulates relationships and social standing.
- The consequences of bullying range from lowered self-esteem to suicide attempts, which may or may not be successful.
- Verbal aggression attacks the self-concept of others rather than attacking an issue.
- Intimate partner violence is pervasive with male and female victims.
- Know your partner's beliefs about the acceptability of aggression and violence.
- There are several ways individuals can attempt to diffuse and downplay the effects of the dark side of interpersonal communication. First, people can learn how to communicate anger effectively. Second, people can develop an affirming communicator style. Lastly, people can learn how to be mindful of their own communicative behavior.

Exercises

- Relational aggression results in hurt and lowered self-esteem. Design a plan to help a child who may experience or enact relational aggression.
- Verbal aggression is a negative form of communication in which the self-concept of another is attacked. Describe a situation in which you engaged in verbal aggression. How will you avoid verbal aggression in future interactions? If you are the target of verbal aggression, how will you approach the perpetrator of this behavior?
- Once entering the workplace, you may become a manager of people, or you may already manage people. How will you help your colleagues and subordinates avoid bullying? If you discover that bullying has occurred, what will you do to correct the situation?

Chapter Wrap-Up

“But beware of the dark side. Anger, fear, aggression...the dark side of the Force are they, easily they flow... If once you start down the dark path, forever will it dominate your destiny. Consume you, it will...”
—Yoda

The concept of “the dark side” stems from the struggle between good and evil put forth by George Lucas in Star Wars back in 1977. The metaphor of “the dark side” has been used by communication scholars to look at a range of interpersonal relationship behaviors that are highly problematic and destructive. We started this chapter by examining a few destructive interpersonal behaviors: secret testing,

Internet infidelity, and hurtful messages. We then switched our focus to the highly destructive world of interpersonal aggression. We looked at both how interpersonal relationships can be both verbally and physically destructive. If you find yourself in a verbally or physically destructive interpersonal relationship, please seek help. No one deserves to be belittled, demeaned, or assaulted.

End of Chapter

KEY TERMS

- Bullying
- Confrontational Behaviors
- Directness
- Endurance Test
- Indirect Suggestions
- Internet Characteristics
- Internet Infidelity
- Intimate Partner Violence
- Nonconfrontational Behaviors
- Physical Bullying
- Reasons for Relational Aggression
- Relational Aggression
- Relational Bullying
- Secret Tests
- Separation Test
- Third-Party Testing
- Triangle Test
- Types of Workplace Bullying
- Verbal Bullying

REAL WORLD CASE STUDY

Carrie's daughter, Diana, had only been at Birmingham School Junior High School a few months when she formed a friendship with three girls: Lisa, Lucy, and Kristen. The girls were great friends, and spent a significant amount of time on the phone and at the mall on the weekends. The girls graduated from 8th grade and moved on to high school. During their freshman year, Diana took a disliking to Lisa and began campaigning against her. At some point, Diana decided that the group should no longer include Lisa. When spending the night with Kristen, Diana asked Kristen to call Lisa to get her to talk about her behind her back. She planned to confront Lisa if she talked about her. She plotted with Lucy and Kristen to get them to ignore Lisa when she came to sit with them at lunch. In a final act to eradicate Lisa from the group, she coaxed Lucy into writing a note Kristen to say that she didn't want to be friends with Lisa anymore. The plan was for Diana to "find" the note and then give it to Lisa so that she could see how Kristen and Lucy felt about her. The girls moved forward with their plan to write the note and give it to Lisa. After Lisa received the note, she went to Kristen to find out what was going on. She was devastated and crying. Kristen felt terrible for her, but she didn't betray her friendship with Diana. Later, Lisa's mom called Carrie to talk about the situation and determine what could be done.

1. What term describes the behavior demonstrated by the girls in the scenario?
1. Is it reasonable to expect Kristen and Lucy to stand up to Diana?
2. What, in your opinion, caused Diana to exclude Lisa?
3. When Carrie found out about her daughter's behavior, what was her responsibility?
4. Was it acceptable for Lisa's mom to call Carrie?
5. What would you do in this situation?

END OF CHAPTER QUIZ

1. Which form of secret test involves physical distance?
 - a. endurance
 - b. separation
 - c. third party
 - d. public presentation
 - e. triangle test

2. Verbal aggression is defined as
 - a. attacking the self-concept of others
 - b. attacking the topic in an argument
 - c. manipulating social relationships of others
 - d. using one's power to intimidate others
 - e. isolating the target of communication

3. Relational aggression is best defined as
 - a. manipulating the social relationships of others
 - b. attacking the self-concept of others
 - c. attacking the topic in an argument
 - d. using one's power to intimidate others
 - e. isolating the target

4. Which of the following is not a form of workplace bullying?
 - a. Damaging professional standing
 - b. Limiting the ability to complete work
 - c. Obstructing due process
 - d. Verbal threats
 - e. Providing counseling through human resources upon reports of bullying

5. Which of the following is not included in playful teasing?
 - a. Parties are Friends
 - b. Repeated occurrences of the same behavior
 - c. Signs of affection
 - d. Parties smile and laugh
 - e. Parties are using teasing to broach difficult topics

References

- 1 Baxter, L. A., & Wilmot, W. W. (1984). Secret tests: Social strategies for acquiring information about the state of the relationship. *Human Communication Research*, 22(2), 171–201. <https://doi.org/10.1111/j.1468-2958.1984.tb00044.x>
- 2 Berger, C.R. & Calabrese, R.J. (1975). Some explorations in initial interaction and beyond: Toward a developmental theory of interpersonal communication. *Human Communication Research*, 1(2), 99-112. <https://doi.org/10.1111/j.1468-2958.1975.tb00258.x>
- 3 Baxter, L.A. & Wilmot, W.W. (1985). Taboo topics in close relationships. *Journal of Social and Personal Relationships*, 2(3), 253–269. <https://doi.org/10.1177/0265407585023002>
- 4 Chory-Assad, R. M., & Booth-Butterfield, M. (2001). Secret test use and self-esteem in deteriorating relationships. *Communication Research Reports*, 18(2), 147-157. <https://doi.org/10.1080/08824090109384792>
- 5 Ibid.
- 6 Ibid.
- 7 Kelley, D. L., & Waldron, V. R. (2005). An investigation of forgiveness-seeking communication and relational outcomes. *Communication Quarterly*, 53(3), 339–358. <https://doi.org/10.1080/01463370500101097>
- 8 McCullough, M. E., Rachal, C. K., Sandage, S. J., Worthington, E. L. Jr., Brown, S. W., & Hight, T. L. (1998). Interpersonal forgiving in close relationships II: Theoretical elaboration and measurement. *Journal of Personality and Social Psychology*, 75(6), 1586–1603. <https://doi.org/10.1037/0022-3514.75.6.1586>
- 9 Darby, B. W., & Schlenker, B. R. (1982). Children's reactions to apologies. *Journal of Personality and Social Psychology*, 43 (4), 742–753. <https://doi.org/10.1037/0022-3514.43.4.742>
- 10 McCullough, M. E., Bono, G., & Root, L. M. (2007). Rumination, emotion, and forgiveness: Three longitudinal studies. *Journal of Personality and Social Psychology*, 92 (3), 490–505. <https://doi.org/10.1037/0022-3514.92.3.490>
- 11 Docan-Morgan, T., & Docan, C. A. (2007). Internet infidelity: Double standards and the differing views of women and men. *Communication Quarterly*, 55(3), 317-342 <https://doi.org/10.1080/01463370701492519>
- 12 Shaw, J. (1997). Treatment rationale for Internet infidelity. *Journal of Sex Education and Therapy*, 22(1), 29–34. <https://doi.org/10.1080/01614576.1997.11074168>
- 13 Docan-Morgan, T., & Docan, C. A. (2007). Internet infidelity: Double standards and the differing views of women and men. *Communication Quarterly*, 55(3), 317-342 <https://doi.org/10.1080/01463370701492519>
- 14 Phillip, A. (2014, July 9). High-priced prostitute arrested in death of a Google executive. *Washington Post*. Retrieved from: <http://www.washingtonpost.com/news/post-nation/wp/2014/07/09/high-priced-prostitute-arrested-for-murder-of-a-google-executive/>
- 15 Barnes, S. B. (2001). *Online communication: Internet interpersonal relationships*. Hampton Press.
- 16 Gurak, L. J. (2001). *Cyberliteracy: Navigating the Internet with awareness*. Yale University Press.
- 17 Turkle, S. (1995). *Life on the screen: Identity in the age of the Internet*. Simon & Schuster.
- 18 Story of Manti Te'o girlfriend a hoax. (2013, January 17). *ESPN.com*. Retrieved from http://espn.go.com/college-football/story/_/id/8851033/story-manti-teo-girlfriend-death-apparently-hoax
- 19 Shackelford, T.K., & Buss, D.M. (1997). Cues to infidelity. *Personality and Social Psychology Bulletin*, 23(10), 1034–1045. <https://doi.org/10.1177/01461672972310004>
- 20 Carpenter, C. J. (2009). *A meta-analysis of sex differences in responses to sexual vs. Emotional infidelity* [Paper Presentation]. International Communication Association. Retrieved from Communication and Mass Media Complete.
- 21 Guerrero, L. K., Spitzberg, B. H., & Yoshimura, S. M. (2004). Sexual and emotional jealousy. In J. Harvey, A. Wenzel, & S. Sprecher (Eds.), *The handbook of sexuality in close relationships* (pp. 311–345). Erlbaum.
- 22 Afifi, W. A., Falato, W. L., & Weiner, J. L. (2001). Identity concerns following a severe relational transgression: The role of discovery method for the relational outcomes of infidelity. *Journal of Social and Personal Relationships*, 18(2), 291–309. <https://doi.org/10.1177/0265407501182007>
- 23 Vangelisti, A. L., & Crumley, L. P. (1998). Reactions to messages that hurt: The influence of relational

- contexts. *Communication Monographs*, 65(3), 173-196. <https://doi.org/10.1080/03637759809376447>; pg. 173.
- 24 Vangelisti, A. L. (1994). Messages that hurt. In W. R. Cupach & B. H. Spitzberg (Eds.), *The dark side of interpersonal communication* (pp. 53–82). Lawrence Erlbaum.
- 25 Vangelisti, A. L., & Crumley, L. P. (1998). Reactions to messages that hurt: The influence of relational contexts. *Communication Monographs*, 65(3), 173-196. <https://doi.org/10.1080/03637759809376447>; p. 173.
- 26 Xie, H., Cairns, B. D., & Cairns, R. B. (2005). The development of aggressive behaviors among girls: Measurement issues, social functions, and differential trajectories. In D. J. Pepler, K. C. Madsen, C. Webster & K. S. Levene (Eds.), *The development and treatment of girlhood aggression* (pp. 105–136). Lawrence Erlbaum.
- 27 Archer, J., & Coyne, S. M. (2005). An integrated review of indirect, relational, and social aggression. *Personality and Social Psychology Review*, 9(3), 212–230. https://doi.org/10.1207/s15327957pspr0903_2
- 28 Coyne, S. M., Archer, J., & Eslea, M. (2006). “We’re not friends anymore! Unless. . .”: The frequency and harmfulness of indirect, relational, and social aggression. *Aggressive Behavior*, 32(4), 294–307. <https://doi.org/10.1002/ab.20126>
- 29 Pronk, R. E., & Zimmer-Gembeck, M. J. (2010). It’s “mean,” but what does it mean to adolescents? Relational aggression described by victims, aggressors, and their peers. *Journal of Adolescent Research*, 25(2), 175–204. <https://doi.org/10.1177/0743558409350504>
- 30 Willer, E. K., & Cupach, W. R. (2008). When “sugar and spice” turn to “fire and ice”: Factors affecting the adverse consequences of relational aggression among adolescent girls. *Communication Studies*, 59(4), 415-429. <https://doi.org/10.1080/10510970802473674>
- 31 Coyne, S. M., Archer, J., & Eslea, M. (2006). “We’re not friends anymore! Unless. . .”: The frequency and harmfulness of indirect, relational, and social aggression. *Aggressive Behavior*, 32(4), 294–307. <https://doi.org/10.1002/ab.20126>
- 32 Underwood, M. K., Galen, B. R., & Paquette, J. A. (2001). Top ten challenges for understanding gender and aggression in children: Why can’t we all just get along? *Social Development*, 10(2), 248–266. <https://doi.org/10.1111/1467-9507.00162>
- 33 Coyne, S. M., Archer, J., Eslea, M., & Liechty, T. (2008). Adolescent perceptions of indirect forms of relational aggression: Sex of perpetrator effects. *Aggressive Behavior*, 34(6), 577–583. <https://doi.org/10.1002/ab.20266>
- 34 Crick, N. R., Bigbee, M. A., & Howes, C. (1996). Gender differences in children’s normative beliefs about aggression: How do I hurt thee? Let me count the ways. *Child Development*, 67(3), 1003–1014. <https://doi.org/10.2307/1131876>
- 35 Merten, D. E. (1997). The meaning of meanness: Popularity, competition, and conflict among junior high school girls. *Sociology of Education*, 70(3), 175–191. <https://doi.org/10.2307/2673207>
- 36 Miller-Ott, A. E., & Kelly, L. (2014). Communication of female relational aggression in the college environment. *Qualitative Research Reports in Communication*, 14(1), 19-27. <https://doi.org/10.1080/17459435.2013.835338>
- 37 Perlman, D., & Carcedo, R. J. (2011). Overview of the dark side of relationships research. In W. R. Cupach and B. H. Spitzberg (Eds.), *The dark side of close relationships II* (pp. 1–37). Routledge.
- 38 Miller-Ott, A. E., & Kelly, L. (2014). Communication of female relational aggression in the college environment. *Qualitative Research Reports in Communication*, 14(1), 19-27. <https://doi.org/10.1080/17459435.2013.835338>
- 39 Miller-Ott, A. E., & Kelly, L. (2014). Communication of female relational aggression in the college environment. *Qualitative Research Reports in Communication*, 14(1), 19-27. <https://doi.org/10.1080/17459435.2013.835338>
- 40 Infante, D. A., & Wigley, C. J. (1986). Verbal aggressiveness: An interpersonal model and measure. *Communication Monographs*, 53(1), 61-69. <https://doi.org/10.1080/03637758609376126>
- 41 Rancer, A. S., Kosberg, R. L., & Silvestri, V. N. (1992). The relationship between self-esteem and aggressive communication predispositions. *Communication Research Reports*, 9(1), 23-32. <https://doi.org/10.1080/08824099209359894>

- 42 Aloia, L., & Solomon, D. (2013). Perceptions of verbal aggression in romantic relationships: The role of family history and motivational systems. *Western Journal of Communication*, 77(4), 411-423. <https://doi.org/10.1080/10570314.2013.776098>
- 43 Jordan-Jackson, F. F., Lin, Y., Rancer, A. S., & Infante, D. A. (2008). Perceptions of males and females' use of aggressive affirming and nonaffirming messages in an interpersonal dispute: You've come a long way baby? *Western Journal of Communication*, 72(3), 239-258. <https://doi.org/10.1080/10570310802210122>
- 44 Infante, D. A., Chandler, T. A., Rudd, J. E., & Shannon, E. A. (1990). Verbal aggression in violent and non-violent marital disputes. *Communication Quarterly*, 38(4), 361-371. <https://doi.org/10.1080/01463379009369773>
- 45 Olweus, D. (1997). Bully/victim problems in school: Facts and intervention. *European Journal of Psychology of Education*, 12(4), 495-510. <https://doi.org/10.1007/BF03172807>
- 46 Futterman, S. (2004). *When you work for a bully: Assessing your options and taking action*. Croce Publishing Group.
- 47 Bauman, S., & Del Rio, A. (2006). Preservice teachers' responses to bullying scenarios: Comparing physical, verbal and relational bullying. *Journal of Educational Psychology*, 98(1), 219-231. <https://doi.org/10.1037/0022-0663.98.1.219>
- 48 Crick, N. R. (1996). The role of overt aggression, relational aggression, and prosocial behavior in the prediction of children's future social adjustment. *Child Development*, 67(5), 2317-2327. <https://doi.org/10.2307/1131625>
- 49 Beaty, L. A., & Alexeyev, E. B. (2008). The problem of school bullies: What the research tells us. *Adolescence*, 43(169), 1-11.
- 50 Clarke, E. A., & Kiselica, M. S. (1997). A systemic counseling approach to the problem of bullying. *Elementary School Guidance & Counseling*, 31(4), 310-325.
- 51 Mills, C., & Carwile, A. (2009). The good, the bad, and the borderline: Separating teasing from bullying. *Communication Education*, 58(2), 276-301. <https://doi.org/10.1080/03634520902783666>
- 52 Patchin, J.W., Hinduja, S. (2006). Bullies move beyond the schoolyard. A preliminary look at cyber bullying. *Youth Violence and Juvenile Justice*, 4 (2), 148-169. <https://doi.org/10.1177/1541204006286288>
- 53 Ibid.
- 54 Hinduja, S., & Patchin, J. W. (2008). Cyberbullying: An exploratory analysis of factors related to offending and victimization. *Deviant Behavior*, 29(2), 129-156. <https://doi.org/10.1080/01639620701457816>
- 55 Bamford, A. (2004). Cyber-bullying. AHISA Pastoral Care National Conference. Retrieved from: www.ahisa.com.au/documents/conferences/PCC2004/bamford.pdf.
- 56 Görzig, A., & Ólafsson, K. (2013). What makes a bully a cyberbully? Unravelling the characteristics of cyberbullies across twenty-five European countries. *Journal of Children & Media*, 7(1), 9-27. <https://doi.org/10.1080/17482798.2012.739756>; pg. 20.
- 57 Hutchinson, M, Vickers M. H., Wilkes, L., & Jackson, D. (2010) A typology of bullying behaviours: the experiences of Australian nurses. *Journal of Clinical Nursing*, 19(15-16), 2319-2328. <https://doi.org/10.1111/j.1365-2702.2009.03160.x>
- 58 Guerrero, L. K. (1994). "I'm so mad I could scream:" The effects of anger expression on relational satisfaction and communication competence. *Southern Communication Journal*, 59(2), 125-141. <https://doi.org/10.1080/10417949409372931>
- 59 Norton, R. W. (1978). Foundation of a communicator style construct. *Human Communication Research*, 4 (2), 99-112. <https://doi.org/10.1111/j.1468-2958.1978.tb00600.x>
- 60 Jordan-Jackson, F. F., Lin, Y., Rancer, A. S., & Infante, D. A. (2008). Perceptions of males and females' use of aggressive affirming and nonaffirming messages in an interpersonal dispute: You've come a long way baby? *Western Journal of Communication*, 72(3), 239-258. <https://doi.org/10.1080/10570310802210122>
- 61 Burgoon, J. K., & Buller, D. B. (1994). Interpersonal deception: III. Effects of deceit on perceived communication and nonverbal behavior dynamics. *Journal of Nonverbal Behavior*, 18, 155-184; pgs. 155-156.
- 62 O'Hair, H. D., & Cody, M. J. (1994). Deception. In W. R. Cupach & B. H. Spitzberg (Eds.), *The dark side of interpersonal communication* (pp. 181-214). Erlbaum.

- 63 Guthrie, J., & Kunkel, A. (2013). Tell me sweet (and not-so-sweet) little lies: Deception in romantic relationships. *Communication Quarterly*, 44(2), 141-157. <https://doi.org/10.1080/10510974.2012.755637>
- 64 Burgoon, J. K., Buller, D. B., Guerrero, L. K., Afifi, W., & Feldman, C. (1996). Interpersonal deception: XII. Information management dimensions underlying deceptive and truthful messages. *Communication Monographs*, 63(1), 50–69. <https://doi.org/10.1080/03637759609376374>
- 65 Guthrie, J., & Kunkel, A. (2013). Tell me sweet (and not-so-sweet) little lies: Deception in romantic relationships. *Communication Quarterly*, 44(2), 141-157. <https://doi.org/10.1080/10510974.2012.755637>
- 66 Ibid.
- 67 *Domestic violence*. National Coalition Against Domestic Violence. Retrieved from https://www.speakcdn.com/assets/2497/domestic_violence2.pdf
- 68 Smith, S.G., Zhang, X., Basile, K.C., Merrick, M.T., Wang, J., Kresnow, M., Chen, J. (2018). *The National Intimate Partner and Sexual Violence Survey (NISVS): 2015 Data Brief – Updated Release*. Atlanta, GA: National Center for Injury Prevention and Control, Centers for Disease Control and Prevention.
- 69 Ibid.
- 70 *Domestic violence*. National Coalition Against Domestic Violence. Retrieved from https://www.speakcdn.com/assets/2497/domestic_violence2.pdf
- 71 Smith, S.G., Zhang, X., Basile, K.C., Merrick, M.T., Wang, J., Kresnow, M., Chen, J. (2018). *The National Intimate Partner and Sexual Violence Survey (NISVS): 2015 Data Brief – Updated Release*. Atlanta, GA: National Center for Injury Prevention and Control, Centers for Disease Control and Prevention; pg. 5.
- 72 Kelty, S. F. (2014). Understanding aggression: Why violent sentiments and aggressive problem-solving strategies should be a clear focus in violent intervention programs. *Journal of Communications Research*, 6(4), 373–417.
- 73 Honeycutt, J., Sheldon, P., & Hardaway, M. (2009). *Escalation of conflict: Differences in perception of male and female initiated abuse*. Paper presented at the National Communication Association. Retrieved from Communication and Mass Media Complete.

END OF CHAPTER QUIZ
ANSWER KEY

- 1) B 2) A 3) A 4) E 5) B



Glossary

Abstract	Refers to words that relate to ideas or concepts that exist only in your mind and do not represent a tangible object.
Abstraction Ladder	A diagram that explains the process of abstraction.
Accent	Nonverbal communication that emphasizes a portion of a message or word rather than the message as a whole.
Accidental Communication	When an individual sends messages to another person without realizing those messages are being sent.
Acting with Awareness	Purposefully focusing one's attention on the activity or interaction in which one is engaged.
Action Model	Communication model that views communication as a one-directional transmission of information from a source or sender to some destination or receiver.
Affect Displays	Kinesics that show feelings and emotions.
Affectionless Psychopathy	The inability to show affection or care about others.
Affective Orientation	An individual's recognition of their own emotions and the emotions of others and reliance on these emotions during decision making processes.
Affiliation	A connection or association with others.
Agape	Selfless love in which the needs of others are the priority.
Alexithymia	A general deficit in emotional vocabulary—the ability to identify emotional feelings, differentiate emotional states from physical sensations, communicate feelings to others, and process emotion in a meaningful way.
Ambiguous Language	Language that has multiple meanings.
Analyzing	This is helpful in gaining different alternatives and perspectives by offering an interpretation of the speaker's message.
Androgynous	A person having both feminine and masculine characteristics.
Anxious Shyness	The fear associated with dealing with others face-to-face.
Appreciative Listening	The type of listening you engage in for pleasure or enjoyment.
Appropriate Communication	Communication tactics that most people would consider acceptable communicative behaviors.
Argument	A verbal exchange between two or more people who have differing opinions on a given subject or subjects.
Argumentativeness	Communication trait that predisposes the individual in communication situations to advocate positions on controversial issues, and to attack verbally the positions which other people take on these issues.

Assertiveness	The degree to which an individual can initiate, maintain, and terminate conversations, according to their interpersonal goals during interpersonal interactions.
Attending	The act of focusing on specific objects or stimuli in the world around you
Attention	Factor of mindful practice that involves being aware of what's happening internally and externally moment-to-moment.
Attitude	Factor of mindful practice that involves being curious, open, and nonjudgmental.
Attraction	Interest in another person and a desire to get to know them better.
Attribution Error	The tendency to explain another individual's behavior in relation to the individual's internal tendencies rather than an external factor.
Authoritarianism	A form of social organization where individuals favor absolute obedience to an authority (or authorities) as opposed to individual freedom.
Autonomy	An individual's independence in their behaviors and thoughts within a marriage relationship.
Avoidance	Conflict management style where an individual attempt to either prevent a conflict from occurring or leaves a conflict when initiated.
Avoiding	The stage of coming apart where you are creating distance from your partner.
Behavioral CQ	The degree to which an individual behaves in a manner that is consistent with what they know about other cultures.
Belief	Assumptions and convictions held by an individual, group, or culture about the truth or existence of something.
Bias	An attitude that is not objective or balanced, prejudiced, or the use of words that intentionally or unintentionally offend people or express an unfair attitude concerning a person's race, ethnicity, sexual orientation, age, disability, or illness.
Biased Language	Language that shows preference in favor of or against a certain point-of-view, shows prejudice, or is demeaning to others.
Bonding	The stage of coming together where you make a public announcement that your relationship exists.
Bullying	Form of aggressive behavior in which a person of greater power attempts to inflict harm or discomfort on individuals and the behavior is repeated over time.
Buzz Word	Informal word or jargon used among a particular group of people.
Career Strategizing	The process of creating a plan of action for one's career path and trajectory.
Channel	The pathways in which messages are conveyed.
Circumscribing	The stage of coming apart where communication decreases. There are more arguments, working late, and there is less intimacy.
Cliché	Expression that has been so overused that it has lost its original meaning.

Co-Culture	Regional, economic, social, religious, ethnic, or other cultural groups that exerts influence in society.
Coercive Power	The ability to punish an individual who does not comply with one's influencing attempts.
Cognitive Complexity	The psychological characteristic that indicates the difficulty or simplicity associated with mental demand.
Cognitive CQ	The degree to which an individual has cultural knowledge.
Cognitive Dispositions	General patterns of mental processes that impact how people respond and react to the world around them.
Collective Self-Esteem	The aspect of an individual's self-worth or self-image that stems from their interaction with others and evaluation of their various social groups.
Collectivism	Characteristics of a culture that values cooperation and harmony and considers the needs of the group to be more important than the needs of the individual.
Collegial peers	Type of coworker with whom we have moderate levels of trust, self-disclosure, and openness.
Colloquialism	Informal expression used in casual conversation that is often specific to certain dialects or geographic regions of a country.
Communication	The process by which we share ideas or information with other people.
Communication Apprehension	The fear or anxiety associated with either real or anticipated communication with another person or persons.
Communication Competence	Communication that is both socially appropriate and personally effective.
Communication Dispositions	General patterns of communicative behavior.
Communication Motives	Reasons why we communicate with others.
Communication Needs	Shows us how communication fulfills our needs.
Comparison Level	Minimum standard of what is acceptable.
Comparison Level of Alternatives	Comparison of what is happening in the relationship and what could be gained in another relationship.
Compatible	Able to exist together harmoniously.
Complement	Nonverbal communication that reinforces verbal communication.
Complementary	When one person can fulfill the other person's needs.
Compliance	When an individual accepts an influencer's influence and alters their thoughts, feelings, and/or behaviors.
Comprehension Listening	Listening for facts, information, or ideas that may be of use to you.
Concept-Orientation	Family communication pattern where freedom of expression is encouraged, and communication is frequent and family life is pleasurable.

Conflict	An interactive process occurring when conscious beings (individuals or groups) have opposing or incompatible actions, beliefs, goals, ideas, motives, needs, objectives, obligations, resources, and/or values.
Confrontational Behaviors	Specific behaviors associated with confrontation or direct behaviors, involves name-calling, cruel teasing, ridicule, and verbal rejection directed at the target.
Connotation	What a word suggests or implies; connotations give words their emotional impact.
Connotative Definitions	The emotions or associations a person makes when exposed to a symbol.
Contact Frequency	This is how often you communicate with another person.
Content Level	Information that is communicated through the denotative and literal meanings of words.
Contradict	Nonverbal communication conveying the opposite meaning of verbal communication.
Converge	Adapting your communication style to the speaker to be similar.
Conversations	Interpersonal interactions through which you share facts and information as well as your ideas, thoughts, and feelings with other people.
Cost Escalation	A form of relational disengagement involving tactics designed to make the cost of maintaining the relationship higher than getting out of the relationship.
Cultural Intelligence	The degree to which an individual can communicate competently in varying cultural situations.
Culture	A group of people who, through a process of learning, can share perceptions of the world, which influence their beliefs, values, norms, and rules, which eventually affect behavior.
Culture as Normative	The basic idea that one's culture provides the rules, regulations, and norms that govern a culture and how people act with other members of that society.
Denotation	The dictionary definition or descriptive meaning of a word.
Denotative Definitions	Definitions for words commonly found in dictionaries.
Depersonalization	A form of relational disengagement where an individual stops all the interaction that is not task-focused or simply avoids the person.
Depression	A psychological disorder characterized by varying degrees of disappointment, guilt, hopelessness, loneliness, sadness, self-doubt, all of which negatively impact a person's general mental and physical wellbeing.
Describing	Being detailed focused on what is occurring while putting it into words.
Deviant Workplace Behavior	The voluntary behavior of organizational members that violates significant organizational norms and practices or threatens the wellbeing of the organization and its members.

Differentiating	The stage of coming apart where both people are trying to figure out their own identities.
Directive Support	The factor of Hersey and Blanchard's situational-leadership model that involves a leader overseeing the day-to-day tasks that a follower accomplishes.
Directness	The least secretive of the strategies and involves asking the relational partner about his/her feelings toward the relationship and commitment to the relationship. Alternatively, an individual might disclose their feelings about the relationship with the hope that the relationship partner will reciprocate.
Disagreement	A difference of opinion between two or more people or groups of people.
Discourse	Spoken or written discussion of a subject.
Dismissing Attachment	Attachment style posed by Kim Bartholomew and Leonard Horowitz describing individuals who see themselves as worthy of love, but generally believe that others will be deceptive and reject them in interpersonal relationships.
Distributive Conflict	A win-lose approach, whereby conflicting parties see their job as to win and make sure the other person or group loses.
Diverge	Adapting your communication style to the speaker to be drastically different.
Dogmatism	The inclination to believe one's point-of-view as undeniably true based on insufficient premises and without consideration of evidence and the opinions of others.
Dominant Culture	The established language, religion, behavior, values, rituals, and social customs of a society.
Dunning-Kruger Effect	The tendency of some people to inflate their expertise when they really have nothing to back up that perception.
Duration	The length of time of your relationship.
Dysfluencies	Speech problems that keep your speech from being as smooth and flowing as it could be.
Ease of Opportunity	When romantic workplace relationships happen because work fosters an environment where people are close to one another.
Effective Communication	Communication that helps an individual achieve a desired personal outcome.
Emblems	Kinesics that are clear and unambiguous and have a verbal equivalent in a given culture.
emotional awareness	An individual's ability to clearly express, in words, what they are feeling and why.
Emotional Blackmail	Trying to influence someone's behavior or persuade them to do something by making them feel guilty or exploiting their emotions.
Emotional Intelligence	An individual's appraisal and expression of their emotions and the emotions of others in a manner that enhances thought, living, and communicative interactions.

Emotional Loneliness	Form of loneliness that occurs when an individual feels that he or she does not have an emotional connection with others.
Emotional Vampires	A colloquial term used to describe individuals with whom we interact that use more of our emotional resources when interacting with people, which often causes an increase in our levels of stress.
Emotions	The physical reactions to stimuli in the outside environment.
Empathic Listening	Attempting to put yourself in another person's shoes or to provide a supportive listening environment.
Empathizing	This is used to show that you identify with the speaker's information.
Empathy	The ability to recognize and mutually experience another person's attitudes, emotions, experiences, and thoughts.
Endurance Test	Form of secret testing in which the partner is tested by engaging in actions that the partner might perceive to be a cost in the relationship.
Environment	The context or situation in which communication occurs.
Eros	Romantic love involving serial monogamous relationships.
Ethics	The set of moral values each person carries throughout life—concepts of what is right and wrong, good and bad, or just and unjust.
Ethics	The judgmental attachment to whether something is good, right, or just.
Ethnocentrism	The degree to which an individual views the world from their own culture's perspective while evaluating different cultures according to their own culture's preconceptions often accompanied by feelings of dislike, mistrust, or hate for cultures deemed inferior.
Euphemism	Replacing blunt words with more polite words.
Evaluative Listening	Listening for a speaker's main points and determining the strengths and weaknesses to formulate a rebuttal or present important points that may not have been covered.
Excuse-Making	Any time an individual attempts to shift the blame for an individual's behavior from reasons more central to the individual to sources outside of their control in the attempt to make themselves look better and more in control.
Experimenting	The stage of coming together "Small talk" occurs at this stage and you are searching for commonalities.
Expert Power	The ability of an individual to influence another because of their level of perceived knowledge or skill.
Expressive	Roles that are relationship-oriented.
Expressive Communication	Messages that are sent either verbally or nonverbally related to an individual's emotions and feelings.
External Locus of Control	The belief that an individual's behavior and circumstances exist because of forces outside the individual's control.
Extraversion	An individual's likelihood to be talkative, dynamic, and outgoing.
Eye Gaze	The act of fixing your eyes on someone.

Face	The standing or position a person has in the eyes of others.
Family	Two or more people tied by marriage, blood, adoption, or choice; living together or apart by choice or circumstance; having interaction within family roles; creating and maintaining a common culture; being characterized by economic cooperation; deciding to have or not to have children, either own or adopted; having boundaries; and claiming mutual affection.
Fearful Attachment	Attachment style posed by Kim Bartholomew and Leonard Horowitz describing individuals who see themselves as unworthy of love and generally believe that others will react negatively through either deception or rejection.
Feedback	Information shared back to the source of communication that keeps the communication moving forward and thus making communication a process.
Feelings	The responses to thoughts and interpretations given to emotions based on experiences, memory, expectations, and personality.
Feminine	Cultures focused on having a good working relationship with one's manager and coworkers, cooperating with people at work, and security (both job and familial).
Followership	The act or condition under which an individual helps or supports a leader in the accomplishment of organizational goals.
Formal Language	Specific writing and spoken style that adheres to strict conventions of grammar that uses complex sentences, full words, and third-person pronouns.
Gender	The psychological characteristics that determine if a person is feminine or masculine.
Genogram	A pictorial representation of a family across generations that can be used to track generations of family interactions, medical issues, psychological issues, relationship patterns, and any other variable a researcher or clinician may be interested in studying.
Goals	Expectations about how the relationship will function.
Group	Three or more people interacting together to achieve a common goal.
Haptics	The study of touch as a form of communication.
Hearing	A passive activity where an individual perceives sound by detecting vibrations through an ear.
Hedge	To use words or phrases that weaken the certainty of a statement.
Heuristic Function	The use of language to explore and investigate the world, solve problems, and learn from your discoveries and experiences.
High-Context Cultures	Cultures that interpret meaning by relying more on nonverbal context or behavior than on verbal symbols in communication.
Ideal-Self	The version of yourself that you would like to be, which is created through our life experiences, cultural demands, and expectations of others.

Identification	When an individual accepts influence because they want to have a satisfying relationship with the influencer or influencing group.
Ideology of traditionalism	Marriages that are marked by a more historically traditional, conservative perspective of marriage.
Idiom	Expression or figure of speech whose meaning cannot be understood by looking at the individual words and interpreting them literally.
Illustrators	Kinesics that emphasize or explain a word.
Imaginative Function	The use of language to play with ideas that do not exist in the real-world.
Importance to Identity	The degree to which group membership is important to an individual.
Independents	Marital definition where couples have a high level of interdependence, an unconventional ideology, and high levels of conflict engagement.
Indigenous Peoples	Populations that originated in a particular place rather than moved there.
Indirect Suggestions	Joking or hinting about more serious stages of a relationships such as marriage or having children.
Individualism	Characteristics of a culture that values being self-reliant and self-motivated, believes in personal freedom and privacy, and celebrates personal achievement.
Individuality	Aspect of Murray Bowen's family system theory that emphasizes that there is a universal, biological life force that propels organisms toward separateness, uniqueness, and distinctiveness.
Indulgence	Cultural orientation marked by immediate gratification for individual desires.
Inflection	Changes in vocal pitch.
Influence	When an individual or group of people alters another person's thinking, feelings, and/or behaviors through accidental, expressive, or rhetorical communication.
Informal Language	Specific writing and spoken style that is more colloquial or common in tone; contains simple, direct sentences; uses contractions and abbreviations; and allows for a more personal approach that includes emotional displays.
Information Peers	Type of coworker who we rely on for information about job tasks and the organization itself.
Informational Power	A social agent's ability to bring about a change in thought, feeling, and/or behavior through information.
Initiating	The stage of coming together where a person is interested in making contact and it is brief.
Instrumental	Roles that are focused on being task-oriented.
Instrumental Function	The use of language as a means for meeting your needs, manipulating and controlling your environment, and expressing your feelings.
Integrating	This is the stage of coming together where you take on an identity as a social unit or give up characteristics of your old self.

Integrative Conflict	A win-win approach to conflict, whereby both parties attempt to come to a settled agreement that is mutually beneficial.
Intensifying	The stage of coming together where two people truly become a couple.
Intensity	The volume of your speech; how loudly or softly you express yourself.
Intention	Factor of mindful practice that involves being aware of why you are doing something.
Interaction Model	Communication model that views the sender and the receiver as responsible for the effectiveness of the communication.
Interaction Variability	The ability to talk about various topics.
Interactional Function	The use of language to help you form and maintain relationships.
Interdependence	When individuals involved in a relationship characterize it as continuous and important.
Interdependent	A relationship in which people need each other or depend on each other in some way, and the actions of one person affect the other.
Internal Locus of Control	The belief that an individual can control their behavior and life circumstances.
Internalization	When an individual adopts influence and alters their thinking, feeling, and/or behaviors because doing so is intrinsically rewarding.
Internet Characteristics	Internet characteristic that influence Internet relationships such as speed, reach, interactivity, and anonymity.
Internet Infidelity	Sexual energy of any sort—thoughts, feelings, and behaviors—outside of a committed sexual relationship in such a way that it damages the relationship, and pretending that this drain in energy will affect neither one's partner nor the relationship as long as it remains undiscovered.
Interpersonal Communication	The exchange of messages between two people.
Interpreting	Interpretation is the act of assigning meaning to a stimulus and then determining the worth of the object (evaluation).
Intimacy	Close and deeply personal contact with another person.
Intimate Partner Violence	Includes physical violence, sexual violence, stalking, and psychological aggression.
Intrapersonal	Something that exists or occurs within an individual's self or mind.
Intrapersonal Communication	Communication phenomena that exist within or occurs because of an individual's self or mind.
Introversion	An individual's likelihood to be quiet, shy, and more reserved
Jargon	The specialized or technical language particular to a specific profession, occupation, or group that is either meaningless or difficult for outsiders to understand.
Johari Window	A model that illustrates self-disclosure and the process by which you interact with other people.

Kinesics	The study of visible means of communicating using body language such as eye behavior, facial expression, body posture and movement, and hand gestures.
Language	A system of human communication using a particular form of spoken or written words or other symbols.
Language Adaptation	The ability to alter one's linguistic choices in a communicatively competent manner
Language Awareness	a person's ability to be mindful and sensitive to all functions and forms of language.
Launching Stage	Period in a family life cycle when late adolescents leave the parental home and venture out into the world as young singles themselves.
Leader-member Exchange	Theory of leadership that explores how leaders enter into two-way relationships with followers through a series of exchange agreements enabling followers to grow or be held back.
Legitimate Power	Influence that occurs because a person (P) believes that the social agent (A) has a valid right (generally based on cultural or hierarchical standing) to influence P, and P has an obligation to accept A's attempt to influence P's thoughts, feelings, and/or behaviors.
Linguistic Determinism	The perspective that language influences thoughts.
Linguistic Relativity	The view that language contains special characteristics.
Listening	A complex psychological process that can be defined as the process of physically hearing, interpreting that sound, and understanding the significance of it.
Locus of Control	An individual's perceived control over their behavior and life circumstances.
Loneliness	An individual's emotional distress that results from a feeling of solitude or isolation from social relationships.
Long-Term Orientation	Cultural orientation where individuals focus on the future and not the present or past.
Love	Love is a multidimensional concept that can include several different orientations toward the loved person such as romantic love (attraction based on physical beauty or handsomeness), best friend love, passionate love, unrequited love (love that is not returned), and companionate love (affectionate love and tenderness between people).
Love Style	Love style is considered an attitude that influences an individual's perception of love.
Low-Context Cultures	Cultures that interpret meaning by placing a great deal of emphasis on the words someone uses.
Ludus	Love in which games are played. Lying and deceit are acceptable.
Machiavellianism	Personality trait posed by Richard Christie where cunningness and deceit are exalted as a means of attaining and maintaining power to accomplish specific, self-centered goals.
Mania	Obsessive love that requires constant reassurance.

Masculine	Cultures focused on items like earnings, recognition, advancement, and challenge.
Maslow's Hierarchy of Needs	Theory of motivation proposed by Abraham Maslow comprising a five-tier, hierarchical pyramid of needs: physiological, safety, love, esteem, and self-actualization.
Maternal Deprivation Hypothesis	Hypothesis posed by John Bowlby that predicts that infants who are denied maternal attachment will experience problematic outcomes later in life.
Mediated Communication	The use of some form of technology to facilitate information between two or more people.
Membership Esteem	The degree to which an individual sees themselves as a "good" member of a group.
Metacognitive CQ	The degree to which an individual is consciously aware of their intercultural interactions in a manner that helps them have more effective interpersonal experiences with people from differing cultures.
Metamessage	The meaning beyond the words themselves.
Microculture	Cultural patterns of behavior influenced by cultural beliefs, values, norms, and rules based on a specific locality or within an organization.
Mindful Awareness	To be consciously aware of your physical presence, cognitive processes, and emotional state while engaged in an activity.
Mindful Communication	The process of interacting with others while engaging in mindful awareness and practice
Mindful Practice	The conscious development of skills such as greater ability to direct and sustain our attention, less reactivity, greater discernment and compassion, and enhanced capacity to disidentify from one's concept of self.
Model	A simplified representation of a system (often graphic) that highlights the important components and connections of concepts, which are used to help people understand an aspect of the real-world.
Motivational CQ	The degree to which an individual desires to engage in intercultural interactions and can easily adapt to differing cultural environments.
Narcissism	A psychological condition (or personality disorder) in which a person has a preoccupation with one's self.
Noise	Anything that can interfere with the message being sent or received.
Nonconfrontational Behaviors	Behaviors include spreading rumors, gossiping, and social manipulation.
Nonjudging of Inner Experience	Being consciously aware of one's thoughts, feelings, and attitudes without judging them.
Nonreactivity to Inner Experience	Taking a step back and evaluating things from a more logical, dispassionate perspective.
Nonverbal Vocalization	A type of paralanguage that consists of sounds, noises, and behaviors that are often accompanied by body language.

Norms	Informal guidelines about what is acceptable or proper social behavior within a specific culture.
Observing	Being aware of what is going on inside yourself and in the external environment.
Oculesics	Communication involving eye behavior such as eye contact, gaze, and avoidance.
Olfactics	The use of scent to communicate.
Organizing	Organizing is making sense of the stimuli or assigning meaning to it.
Ostracized	Excluded or removed from a group by others in that group.
Paralanguage	Voice characteristics and nonverbal vocalizations that communicate feelings, intentions, and meanings.
Paraphrase	To restate what another person said using different words.
Perception	The process of acquiring, interpreting, and organizing information that comes in through your five senses.
Personal Function	The use of language to help you form your identity or sense of self.
Personal responsibility	An individual's willingness to be accountable for how they feel, think, and behave.
Personality	The combination of traits or qualities such as behavior, emotional stability, and mental attributes that make a person unique.
Physical Attraction	The degree to which one person finds another person aesthetically pleasing.
Physical Bullying	Involves hitting, kicking, pulling hair, strapping a female's bra strap or giving a "wedgie."
Pitch	The placement of your voice on the musical scale; the basis on which singing voices are classified as soprano, alto, tenor, baritone, or bass voices.
platonic	A close relationship that is not physical.
Power	The degree that a social agent (A) has the ability to get another person(s) (P) to alter their thoughts, feelings, and/or behaviors.
Power Distance	The degree to which those people and organizations with less power within a culture accept and expect that power is unequally distributed within their culture.
Pragma	Love involving logic and reason.
Preoccupied Attachment	Attachment style posed by Kim Bartholomew and Leonard Horowitz describing individuals who do not perceive themselves as worthy of love, but do generally see people as trustworthy and available for interpersonal relationships.
Private Collective Esteem	The degree to which an individual positively evaluates their group.
Procedural Disagreements	Disagreements concerned with procedure, how a decision should be reached or how a policy should be implemented.
Profession	An occupation that involves mastery of complex knowledge and skills through prolonged training, education, or practical experience.

Professionalism	The aims and behaviors that demonstrate an individual's level of competence expected by a professional within a given profession.
Proxemics	The use of space to communicate.
Public Collective Self-Esteem	The degree to which nonmembers of a group evaluate a group and its members either positively or negatively.
Public Communication	Form of communication where an individual or group of individuals sends a specific message to an audience.
Racism	Bias against others on the basis of their race or ethnicity.
Racist Language	Language that demeans or insults people based on their race or ethnicity.
Reasons for Relational Aggression	Women's explanations for relational aggression: (a) girls will be girls; (b) venting; (c) blaming the victim; (d) minimizing their role; and (e) regret
Receiver	The receiver decodes the message in an environment that includes noise.
Referent Power	A social agent's (A) ability to influence another person (P) because P wants to be associated with A.
Regulate	Nonverbal communication which controls the flow of conversation.
Regulators	Kinesics that help coordinate the flow of conversation.
Regulatory Function	The use of language to control behavior.
Rejection Sensitivity	The degree to which an individual expects to be rejected, readily perceives rejection when occurring, and experiences an intensely negative reaction to that rejection.
Relational Aggression	Behaviors that harm others. Harm is created through damaging social relationship or feelings of acceptance.
Relational Bullying	The manipulation of social relationships to inflict hurt upon another individual.
Relational Dispositions	General patterns of mental processes that impact how people view and organize themselves in relationships.
Relational Maintenance	Degree of difficulty individuals experience in interpersonal relationships due to misunderstandings, incompatibility of goals, and the time and effort necessary to cope with disagreements.
Relationship	A connection, association, or attachment that people have with each other.
Relationship Dialectic	Tensions in a relationship where individuals need to deal with integration vs. separation, expression vs. privacy, and stability vs. change.
Relationship Level	The type of relationship between people as evidenced through their communication.
Relationship Maintenance	Strategies to help your relationship be successful and satisfying.
Relative Language	Language that gains understanding by comparison.
Repeat	Nonverbal communication that repeats verbal communication, but could stand alone.

Representational Function	The use of language to represent objects and ideas and to express your thoughts.
Responsiveness	The degree to which an individual considers other's feelings, listens to what others have to say, and recognizes the needs of others during interpersonal interactions.
Restraint	Cultural orientation marked by the belief that gratification should not be instantaneous and should be regulated by cultural rules and norms.
Reward Power	The ability to offer an individual rewards for complying with one's influencing attempts.
Rhetorical Communication	Purposefully creating and sending messages to another person in the hopes of altering another person's thinking, feelings, and/or behaviors.
Rhythm	Variation in the flow of your voice created by differences in the pitch, intensity, tempo, and length of word syllables.
Right-Wing Authoritarians	Individuals who believe in submitting themselves to established, legitimate authorities; strict adherence to social and cultural norms; and the need to punish those who do not submit to authorities or who violate social and cultural norms.
Romantic Relationships	Romantic relationships involve a bond of affection with a specific partner that researchers believe involves several psychological features: a desire for emotional closeness and union with the partner, caregiving, emotional dependency on the relationship and the partner, a separation anxiety when the other person is not there, and a willingness to sacrifice for the other love.
Romantic Workplace Relationship	When two employees have acknowledged their mutual attraction to one another and have physically acted upon their romantic feelings in the form of a dating or otherwise intimate association.
Rules	Explicit guidelines (generally written down) that govern acceptable or proper social behavior within a specific culture.
Sapir-Whorf Hypothesis	A theory that suggests that language impacts perceptions. Language is ascertained by the perceived reality of a culture.
Secret Tests	Indirect strategies individuals use to assess the state of their relationship.
Secure Attachment	Attachment style posed by Kim Bartholomew and Leonard Horowitz describing individuals who believe that they are loveable and expect that others will generally behave in accepting and responsive ways within interpersonal interactions.
Self-Concept	An individual's relatively stable mental picture of him or herself.
Self-Conscious Shyness	Feeling conspicuous or socially exposed when dealing with others face-to-face.
Self-Disclosure	The act of verbally or nonverbally revealing information about yourself to other people.
Self-Disclosure	The process of sharing information with another person.
Self-Esteem	An individual's subjective evaluation of their abilities and limitations.

Self-Image	The view an individual has of themselves.
Self-Monitoring	The theory that individuals differ in the degree to which they can control their behaviors in accordance with the appropriate social rules and norms involved in interpersonal interaction.
Self-Worth	The degree to which you see yourself as a good person who deserves to be valued and respected.
Separates	Marital definition where couples have low interdependence, conventional ideology, and low levels of conflict engagement.
Separation Test	Creating physical distance to test the strength of the relationship.
Sex	The biological characteristics that determine a person as male or female.
Sexism	Bias of others based on their biological sex.
Sexist Language	Language that excludes individuals on the basis of gender or shows a bias toward or against people due to their gender.
Sharing	The process of revealing and disclosing information about yourself with another.
Short-Term Orientation	Cultural orientation where individuals focus on the past or present and not in the future.
Shyness	Discomfort when an individual is interacting with another person(s) in a social situation.
Sibling Hostility	Characteristic of sibling relationships where sibling behaviors as causing trouble, getting into fights, teasing/name-calling, taking things without permission, etc.
Sibling Warmth	Characteristic of sibling relationships where sibling behaviors such as sharing secrets, helping each other, teaching each other, showing physical affection, sharing possessions, etc.
Silent Listening	This occurs when you say nothing and is appropriate for certain situations.
Similarity	When romantic workplace relationships occur because people find coworkers have similar personalities, interests, backgrounds, desires, needs, goals, etc....
Slang	The nonstandard language of a particular culture or subculture.
Social Attraction	The degree to which an individual sees another person as entertaining, intriguing, and fun to be around.
Social Loneliness	Form of loneliness that occurs from a lack of a satisfying social network.
Social Penetration Theory	Theory originally created by Altman and Taylor to explain how individuals gradually become more intimate as individuals self-disclose more and those self-disclosures become more intimate (deep).
Social Support	The perception and actuality that an individual receives assistance, care, and help from those people within their life.
Social-Personal Dispositions	General patterns of mental processes that impact how people socially relate to others or view themselves.

Sociocommunicative Orientation	The degree to which an individual communicates using responsive or assertive communication techniques.
Socio-Orientation	Family communication pattern where similarity is valued over individuality and self-expression, and harmony is preferred over expression of opinion.
Source	The person initiating communication and encoding the message and selecting the channel.
Special Peer	Type of coworker relationship marked by high levels of trust and self-disclosure; like a “best friend” in the workplace.
Spin	The manipulation of language to achieve the most positive interpretation of words, to gain political advantage, or to deceive others.
Stagnating	The stage of coming apart where you are behaving in old familiar ways without much feeling. In other words, there is lost enthusiasm for old familiar things.
State-of-the-Relationship Talk	A form of relational disengagement where an individual explains to a coworker that a workplace friendship is ending.
Static Evaluation	Language shows that people and things change.
Stereotype	A set of beliefs about the personal attributes of a social group.
Storge	Love that develops slowly out of friendship.
Substantive Disagreement	A disagreement that people have about a specific topic or issue.
Substitute	Nonverbal communication that has a direct verbal translation.
Support	The ability to provide assistance, aid, or comfort to another.
Supportive Leadership Behavior	The factor of Hersey and Blanchard’s situational-leadership model that occurs when a leader is focused on providing relational support for their followers
Symbol	A mark, object, or sign that represents something else by association, resemblance, or convention
Symmetrical Relationship	A relationship between people who see themselves as equals.
System	Sets of elements standing in interrelation.
Task Attraction	The degree to which an individual is attracted to another person because they possess specific knowledge and/or skills that help that individual accomplish specific goals.
Temperament	The genetic predisposition that causes an individual to behave, react, and think in a specific manner.
Tempo	The rate of your speech; how slowly or quickly you talk.
Terminating	This is a summary of where the relationship has gone wrong and a desire to quit. It usually depends on: problems (sudden/gradual); negotiations to end (short/long); the outcome (end/continue in another form).
The Hookup	When romantic workplace relationships occur because individuals want to engage in casual sex without any romantic entanglements.

Third-Culture	When a couple negotiates their cultural background with the cultural background of their partner essentially creating a third-culture or hybrid culture between the two.
Third-Party Testing	Involving a third party such as friend or family to gain insight into the relationship.
Timbre	(pronounced “TAM-ber”) The overall quality and tone, which is often called the “color” of your voice; the primary vocal quality that makes your voice either pleasant or disturbing to listen to.
Time	When romantic workplace relationships occur because people put in a great deal of time at work, so they are around and interact with potential romantic partners a great deal of the average workday.
Togetherness	Aspect of Murray Bowen’s family system theory that emphasizes the complementary, universal, biological life force that propels organisms toward relationship, attachment, and connectedness.
Tolerance for Disagreement	The degree to which an individual can openly discuss differing opinions without feeling personally attacked or confronted.
Traditionals	Marital definition where couples are highly interdependent, conventional ideology, and high levels of conflict engagement
Transactional Model	Communication model that demonstrate that individuals are often acting as both the sender and receiver simultaneously.
Triangle Test	Manipulating a third party to gain information about the nature of the relationship.
Types of Workplace Bullying	Workplace bullying involves isolation and exclusion, intimidation and threats, verbal threats, damaging professional identity, limiting career opportunities, obstructing work or making work-life difficult, and denial of due process and natural justice.
Uncertainty Avoidance	The extent to which cultures as a whole are fearful of ambiguous and unknown situations.
Uncertainty Reduction Theory	The tendency of human beings to eliminate unknown elements of individuals whom they have just met. Individuals wish to predict what another person thinks and how another person behaves. Strategies for reducing uncertainty include passive, active, and interactive.
Undifferentiated	A person who does not possess either masculine or feminine characteristics.
Undifferentiated space	The degree to which spouses do not see her/his/their ownership of personal belongings as much as they do ownership as a couple.
Values	Important and lasting principles or standards held by a culture about desirable and appropriate courses of action or outcomes.
Verbal Aggression	The tendency to attack the self-concept of individuals instead of, or in addition to, their positions on topics of communication.
Verbal Bullying	Includes threats, degrading comments, teasing, name-calling, putdown or sarcastic comments
Verbal Surrogates	The sounds humans make as they attempt to fill dead air while they are thinking of what to say next (e.g., uhh, umm).

Versatility	The degree to which an individual can utilize both responsiveness and assertiveness that is appropriate and effective during various communication contexts and interpersonal interactions.
Vocabulary	All the words understood by a person or group of people.
Vocalics	Vocal utterances, other than words, that serve as a form of communication.
Willingness to Communicate	An individual's tendency to initiate communicative interactions with other people.
Workplace Socialization	The process by which new organizational members learn the rules (e.g., explicit policies, explicit procedures, etc.), norms (e.g., when you go on break, how to act at work, who to eat with, who not to eat with), and culture (e.g., innovation, risk-taking, team orientation, competitiveness) of an organization.
"You" Statements	Moralistic judgments where we imply the wrongness or badness of another person and the way they have behaved.

Glossary Note

Some of the definitions used within this glossary were direct quotations used within the body of the text. For purposes of the glossary, we did not include the references. If you plan on citing a definition, please cite from the body of the text.